

# Intel® Desktop Board DQ57TM Technical Product Specification

*January 2010*

*Order Number: E83547-001US*

The Intel® Desktop Board DQ57TM may contain design defects or errors known as errata that may cause the product to deviate from published specifications. Current characterized errata are documented in the Intel Desktop Board DQ57TM Specification Update.

# Revision History

---

Revision	Revision History	Date
-001	First release of the Intel® Desktop Board DQ57TM Technical Product Specification	January 2010

This product specification applies to only the standard Intel® Desktop Board DQ57TM with BIOS identifier TMIBX10H.86A.

Changes to this specification will be published in the Intel Desktop Board DQ57TM Specification Update before being incorporated into a revision of this document.

INFORMATION IN THIS DOCUMENT IS PROVIDED IN CONNECTION WITH INTEL® PRODUCTS. NO LICENSE, EXPRESS OR IMPLIED, BY ESTOPPEL OR OTHERWISE, TO ANY INTELLECTUAL PROPERTY RIGHTS IS GRANTED BY THIS DOCUMENT. EXCEPT AS PROVIDED IN INTEL'S TERMS AND CONDITIONS OF SALE FOR SUCH PRODUCTS, INTEL ASSUMES NO LIABILITY WHATSOEVER, AND INTEL DISCLAIMS ANY EXPRESS OR IMPLIED WARRANTY, RELATING TO SALE AND/OR USE OF INTEL PRODUCTS INCLUDING LIABILITY OR WARRANTIES RELATING TO FITNESS FOR A PARTICULAR PURPOSE, MERCHANTABILITY, OR INFRINGEMENT OF ANY PATENT, COPYRIGHT OR OTHER INTELLECTUAL PROPERTY RIGHT. UNLESS OTHERWISE AGREED IN WRITING BY INTEL, THE INTEL PRODUCTS ARE NOT DESIGNED NOR INTENDED FOR ANY APPLICATION IN WHICH THE FAILURE OF THE INTEL PRODUCT COULD CREATE A SITUATION WHERE PERSONAL INJURY OR DEATH MAY OCCUR.

All Intel® desktop boards are evaluated as Information Technology Equipment (I.T.E.) for use in personal computers (PC) for installation in homes, offices, schools, computer rooms, and similar locations. The suitability of this product for other PC or embedded non-PC applications or other environments, such as medical, industrial, alarm systems, test equipment, etc. may not be supported without further evaluation by Intel.

Intel Corporation may have patents or pending patent applications, trademarks, copyrights, or other intellectual property rights that relate to the presented subject matter. The furnishing of documents and other materials and information does not provide any license, express or implied, by estoppel or otherwise, to any such patents, trademarks, copyrights, or other intellectual property rights.

Intel may make changes to specifications and product descriptions at any time, without notice.

Designers must not rely on the absence or characteristics of any features or instructions marked "reserved" or "undefined." Intel reserves these for future definition and shall have no responsibility whatsoever for conflicts or incompatibilities arising from future changes to them.

Intel desktop boards may contain design defects or errors known as errata, which may cause the product to deviate from published specifications. Current characterized errata are available on request.

Contact your local Intel sales office or your distributor to obtain the latest specifications before placing your product order.

Copies of documents which have an ordering number and are referenced in this document, or other Intel literature, may be obtained from:

Intel Corporation  
P.O. Box 5937  
Denver, CO 80217-9808

or call in North America 1-800-548-4725, Europe 44-0-1793-431-155, France 44-0-1793-421-777, Germany 44-0-1793-421-333, other Countries 708-296-9333.

Intel, Core, Pentium, and Xeon are trademarks of Intel Corporation or its subsidiaries in the United States and other countries.

\* Other names and brands may be claimed as the property of others.

Copyright © 2010, Intel Corporation. All rights reserved.

# Preface

---

This Technical Product Specification (TPS) specifies the board layout, components, connectors, power and environmental requirements, and the BIOS for the Intel® Desktop Board DQ57TM.

## Intended Audience

The TPS is intended to provide detailed, technical information about the Intel Desktop Board DQ57TM and its components to the vendors, system integrators, and other engineers and technicians who need this level of information. It is specifically *not* intended for general audiences.

## What This Document Contains

Chapter	Description
1	A description of the hardware used on the Intel Desktop Board DQ57TM
2	A map of the resources of the Intel Desktop Board
3	The features supported by the BIOS Setup program
4	A description of the BIOS error messages, beep codes, and POST codes
5	Regulatory compliance and battery disposal information

## Typographical Conventions

This section contains information about the conventions used in this specification. Not all of these symbols and abbreviations appear in all specifications of this type.

## Notes, Cautions, and Warnings



### **NOTE**

*Notes call attention to important information.*



### **CAUTION**

*Cautions are included to help you avoid damaging hardware or losing data.*

## Other Common Notation

#	Used after a signal name to identify an active-low signal (such as USBP0#)
GB	Gigabyte (1,073,741,824 bytes)
GB/s	Gigabytes per second
Gb/s	Gigabits per second
KB	Kilobyte (1024 bytes)
Kbit	Kilobit (1024 bits)
kbits/s	1000 bits per second
MB	Megabyte (1,048,576 bytes)
MB/s	Megabytes per second
Mbit	Megabit (1,048,576 bits)
Mbits/s	Megabits per second
xxh	An address or data value ending with a lowercase h indicates a hexadecimal value.
x.x V	Volts. Voltages are DC unless otherwise specified.
*	This symbol is used to indicate third-party brands and names that are the property of their respective owners.

# Contents

---

## 1 Product Description

1.1	Overview.....	9
1.1.1	Feature Summary .....	9
1.1.2	Board Layout .....	11
1.1.3	Block Diagram .....	13
1.2	Legacy Considerations.....	14
1.3	Online Support.....	14
1.4	Processor .....	14
1.5	Intel® Q57 Express Chipset.....	15
1.6	System Memory .....	15
1.6.1	Memory Configurations .....	16
1.7	Graphics Subsystem .....	18
1.7.1	Integrated Graphics.....	18
1.7.2	PCI Express x16 Graphics.....	19
1.8	USB.....	19
1.9	SATA Interfaces .....	20
1.10	Legacy I/O Controller.....	21
1.10.1	Serial Port.....	21
1.11	Audio Subsystem.....	21
1.11.1	Audio Subsystem Software .....	21
1.11.2	Audio Headers and Connectors .....	22
1.12	LAN Subsystem.....	23
1.12.1	Intel® 82578DM Gigabit Ethernet Controller .....	23
1.12.2	LAN Subsystem Software.....	23
1.12.3	RJ-45 LAN Connector with Integrated LEDs .....	24
1.13	Real-Time Clock Subsystem .....	25
1.14	Thermal Monitoring.....	26
1.15	Platform Management and Security.....	27
1.15.1	Hardware Management Subsystem .....	27
1.15.2	Intel® vPro™ Technology .....	28
1.16	Power Management .....	33
1.16.1	ACPI.....	34
1.16.2	Hardware Support .....	37
1.16.3	ENERGY STAR* 5.0, e-Standby, and ErP Compliance .....	41

## 2 Technical Reference

2.1	Memory Resources .....	43
2.1.1	Addressable Memory.....	43
2.1.2	Memory Map.....	45
2.2	Connectors and Headers.....	45
2.2.1	Back Panel Connectors.....	46
2.2.2	Component-side Connectors and Headers .....	47
2.3	BIOS Configuration Jumper Block.....	56

2.4	Clear CMOS Header .....	58
2.5	Mechanical Considerations .....	59
2.5.1	Form Factor.....	59
2.6	Electrical Considerations.....	60
2.6.1	Power Supply Considerations .....	60
2.6.2	Fan Header Current Capability.....	61
2.6.3	Add-in Board Considerations .....	61
2.7	Thermal Considerations.....	62
2.8	Reliability .....	64
2.9	Environmental .....	64

### **3 Overview of BIOS Features**

3.1	Introduction .....	65
3.2	System Management BIOS (SMBIOS).....	67
3.3	Legacy USB Support .....	67
3.4	BIOS Updates .....	68
3.4.1	Language Support.....	68
3.4.2	Custom Splash Screen .....	69
3.5	BIOS Recovery.....	69
3.6	Boot Options.....	70
3.6.1	Optical Drive Boot .....	70
3.6.2	Network Boot.....	70
3.6.3	Booting Without Attached Devices.....	70
3.6.4	Changing the Default Boot Device During POST .....	70
3.7	Hard Disk Drive Password Security Feature .....	71
3.8	BIOS Security Features .....	72

### **4 Error Messages and Beep Codes**

4.1	Speaker .....	75
4.2	BIOS Beep Codes .....	75
4.3	Front-panel Power LED Blink Codes .....	76
4.4	BIOS Error Messages .....	76
4.5	Port 80h POST Codes .....	77

### **5 Regulatory Compliance and Battery Disposal Information**

5.1	Regulatory Compliance.....	83
5.1.1	Safety Standards.....	83
5.1.2	European Union Declaration of Conformity Statement.....	84
5.1.3	Product Ecology Statements.....	85
5.1.4	EMC Regulations .....	89
5.1.5	Product Certification Markings (Board Level).....	90
5.2	Battery Disposal Information.....	91

## Figures

1.	Major Board Components.....	11
2.	Block Diagram .....	13
3.	Memory Channel and DIMM Configuration .....	17
4.	Back Panel Audio Connector Options .....	22
5.	LAN Connector LED Locations.....	24
6.	Thermal Sensors and Fan Headers .....	26
7.	Location of the Intel ME "M" State LED .....	31
8.	Location of the Standby Power LED (Green) .....	40
9.	Detailed System Memory Address Map .....	44
10.	Back Panel Connectors .....	46
11.	Component-side Connectors and Headers .....	47
12.	Connection Diagram for Front Panel Header .....	53
13.	Connection Diagram for Front Panel USB Headers .....	55
14.	Location of the Jumper Block.....	56
15.	CMOS Clear Header .....	58
16.	Board Dimensions .....	59
17.	Localized High Temperature Zones.....	63

## Tables

1.	Feature Summary.....	9
2.	Components Shown in Figure 1 .....	12
3.	Supported Memory Configurations .....	15
4.	LAN Connector LED States .....	24
5.	Intel ME "M" State LED Behavior.....	30
6.	Effects of Pressing the Power Switch .....	34
7.	Power States and Targeted System Power.....	35
8.	Wake-up Devices and Events .....	36
9.	System Memory Map .....	45
10.	Component-side Connectors and Headers Shown in Figure 11.....	48
11.	Serial Port Header .....	49
12.	S/PDIF Header .....	49
13.	Internal Mono Speaker Header .....	49
14.	Front Panel Audio Header for Intel HD Audio.....	49
15.	Front Panel Audio Header for AC '97 Audio .....	50
16.	Front Panel USB Header .....	50
17.	SATA Connectors.....	50
18.	Chassis Intrusion Header .....	50
19.	Processor (4-Pin) Fan Header .....	51
20.	Front and Rear Chassis Fan Headers .....	51
21.	Intel Remote PC Assist Technology Header.....	51
22.	Processor Core Power Connector.....	52
23.	Main Power Connector.....	52
24.	Front Panel Header .....	53
25.	States for a One-Color Power LED.....	54
26.	Alternate Front Panel Power LED Header.....	54

## Intel Desktop Board DQ57TM Technical Product Specification

27.	BIOS Setup Configuration Jumper Settings.....	57
28.	Clear CMOS .....	58
29.	Recommended Power Supply Current Values .....	60
30.	Fan Header Current Capability.....	61
31.	Thermal Considerations for Components .....	63
32.	Environmental Specifications.....	64
33.	BIOS Setup Program Menu Bar.....	66
34.	BIOS Setup Program Function Keys.....	66
35.	Acceptable Drives/Media Types for BIOS Recovery .....	69
36.	Boot Device Menu Options .....	70
37.	Master Key and User Hard Drive Password Functions .....	71
38.	Supervisor and User Password Functions.....	73
39.	BIOS Beep Codes .....	75
40.	Front-panel Power LED Blink Codes.....	76
41.	BIOS Error Messages .....	76
42.	Port 80h POST Code Ranges.....	77
43.	Port 80h POST Codes .....	78
44.	Typical Port 80h POST Sequence.....	81
45.	Safety Standards.....	83
46.	Lead-Free Board Markings .....	88
47.	EMC Regulations .....	89
48.	Product Certification Markings .....	90



# 1 Product Description

## 1.1 Overview

### 1.1.1 Feature Summary

Table 1 summarizes the major features of the board.

**Table 1. Feature Summary**

<b>Form Factor</b>	MicroATX (9.60 inches by 9.60 inches [243.84 millimeters by 243.84 millimeters])
<b>Processor</b>	<ul style="list-style-type: none"><li>• Intel® Core™ i7, Intel® Core™ i5, Intel® Core™ i3, Intel® Pentium® processors, and Intel® Xeon® processor 3400 series in an LGA1156 socket:<ul style="list-style-type: none"><li>– Integrated graphics processing (processors with Intel® Graphics Technology)</li><li>– External graphics interface controller</li><li>– Integrated memory controller</li></ul></li></ul>
<b>Chipset</b>	Intel® Q57 Express Chipset consisting of the Intel® Q57 Platform Controller Hub (PCH)
<b>Memory</b>	<ul style="list-style-type: none"><li>• Four 240-pin DDR3 SDRAM Dual Inline Memory Module (DIMM) sockets</li><li>• Support for DDR3 1333 MHz and DDR3 1066 MHz DIMMs</li><li>• Support for 1 Gb and 2 Gb memory technology</li><li>• Support for up to 16 GB of system memory with four DIMMs using 2 Gb memory technology</li><li>• Support for non-ECC memory</li><li>• Support for unbuffered ECC memory with Intel Xeon processor 3400 series</li></ul>
<b>Graphics</b>	<ul style="list-style-type: none"><li>• Integrated graphics support for processors with Intel® Graphics Technology:<ul style="list-style-type: none"><li>– DVI-I</li><li>– DVI-D</li><li>– DisplayPort*</li></ul></li><li>• Discrete graphics support for PCI Express 2.0 x16 add-in graphics card</li></ul>
<b>Audio</b>	<ul style="list-style-type: none"><li>• Intel® High Definition Audio:<ul style="list-style-type: none"><li>– Realtek* ALC662 audio codec</li><li>– S/PDIF audio header</li><li>– DisplayPort Digital Audio</li></ul></li></ul>
<b>Peripheral Interfaces</b>	<ul style="list-style-type: none"><li>• Fourteen USB 2.0 ports:<ul style="list-style-type: none"><li>– Six ports are implemented with stacked back panel connectors</li><li>– Eight front panel ports are implemented through four dual-port internal headers</li></ul></li><li>• Six SATA interfaces through the Intel Q57 Express Chipset with Intel® Rapid Storage Technology RAID support:<ul style="list-style-type: none"><li>– Four internal SATA 3.0 Gb/s ports</li><li>– One internal eSATA 3.0 Gb/s port</li><li>– One backpanel eSATA 3.0 Gb/s port</li></ul></li><li>• One serial port header</li></ul>
<b>Legacy I/O Control</b>	<ul style="list-style-type: none"><li>• Nuvoton* W83677 Super I/O controller for hardware management and serial port support</li></ul>

continued

**Table 1. Feature Summary (continued)**

<b>BIOS</b>	<ul style="list-style-type: none"> <li>• Intel® BIOS resident in the SPI Flash device</li> <li>• Support for Advanced Configuration and Power Interface (ACPI), Plug and Play, and SMBIOS</li> </ul>
<b>Instantly Available PC Technology</b>	<ul style="list-style-type: none"> <li>• Support for PCI* Local Bus Specification Revision 2.2</li> <li>• Support for PCI Express*</li> <li>• Suspend to RAM support</li> <li>• Wake on PCI, PCI Express, LAN, front panel, serial, and USB ports</li> </ul>
<b>LAN Support</b>	Gigabit (10/100/1000 Mbits/s) LAN subsystem using the Intel® 82578DM Gigabit Ethernet Controller
<b>Expansion Capabilities</b>	<ul style="list-style-type: none"> <li>• One PCI Express 2.0 x16 add-in card connector</li> <li>• Two PCI Express 2.0 x1 add-in card connectors</li> <li>• One Conventional PCI bus connector</li> </ul>
<b>Hardware Monitor Subsystem</b>	<ul style="list-style-type: none"> <li>• Intel® Quiet System Technology (Intel® QST) implemented through Intel® Management Engine (Intel® ME) in the Intel Q57 PCH</li> <li>• Voltage sense to detect out of range power supply voltages</li> <li>• Thermal sense to detect out of range thermal values</li> <li>• Three fan headers using PWM control</li> <li>• 4-pin headers for processor, front, and rear fans</li> <li>• 4-wire and 3-wire (linear) fan speed control support for front and rear fans</li> <li>• Support for Platform Environmental Control Interface (PECI)</li> </ul>
<b>Intel® vPro™ Technology</b>	<ul style="list-style-type: none"> <li>• Intel® Advanced Management Technology (Intel® AMT) 6.0</li> <li>• Intel® Trusted Execution Technology (Intel® TXT)</li> <li>• Intel® Remote PC Assist (Intel® RPAT)</li> <li>• Intel® Fast Call for Help</li> <li>• Intel® Virtualization Technology (Intel® VT)</li> <li>• Intel® Virtualization for Directed I/O (Intel® VT-d)</li> </ul>

### 1.1.2 Board Layout

Figure 1 shows the location of the major components on Intel Desktop Board DQ57TM.

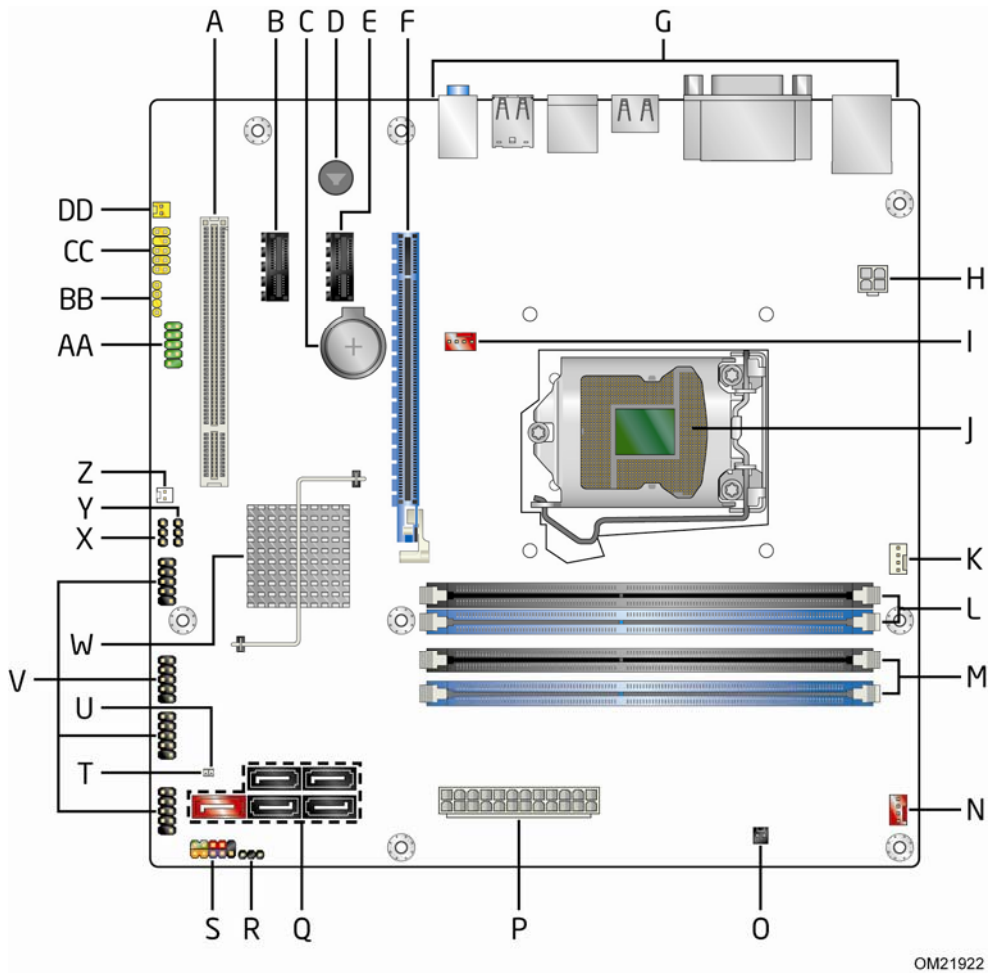

**Figure 1. Major Board Components**

Table 2 lists the components identified in Figure 1.

**Table 2. Components Shown in Figure 1**

<b>Item/callout from Figure 1</b>	<b>Description</b>
A	Conventional PCI bus add-in card connector
B	PCI Express x1 add-in card connector
C	Battery
D	Piezoelectric speaker
E	PCI Express x1 add-in card connector
F	PCI Express x16 add-in card connector
G	Back panel connectors
H	12 V internal power connector (ATX12V)
I	Rear chassis fan header
J	LGA1156 processor socket
K	Processor fan header
L	DIMM Channel A sockets (2)
M	DIMM Channel B sockets (2)
N	Front chassis fan header
O	Chassis intrusion header
P	Main power connector (2 x 12)
Q	SATA connectors
R	Alternate front panel power LED header
S	Front panel header
T	Standby power LED
U	Intel ME "M" state LED
V	Front panel USB headers (4)
W	Intel Q57 Express Chipset
X	BIOS setup configuration jumper block
Y	Clear CMOS header
Z	Intel Remote PC Assist header
AA	Serial port header
BB	S/PDIF header
CC	Front panel audio header
DD	Internal mono speaker header

### 1.1.3 Block Diagram

Figure 2 is a block diagram of the major functional areas of the board.

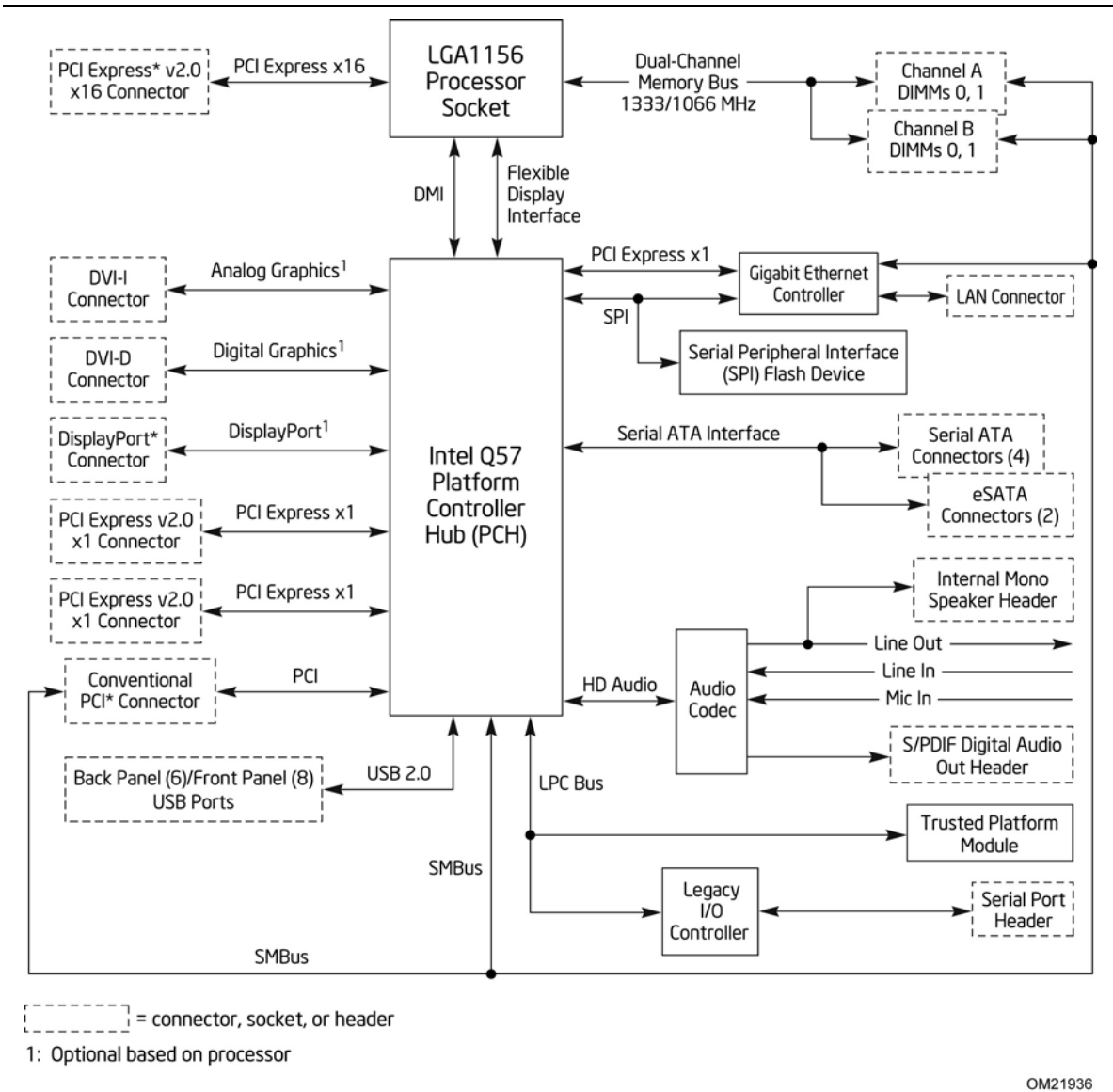

Figure 2. Block Diagram

## 1.2 Legacy Considerations

This board differs from other Intel Desktop Board products, with specific changes including (but not limited to) the following:

- No floppy drive connector
- No PS/2 connector
- No Parallel ATA (PATA) IDE drive connector

## 1.3 Online Support

To find information about...	Visit this World Wide Web site:
Intel Desktop Board DQ57TM	<a href="http://www.intel.com/products/motherboard/DQ57TM/index.htm">http://www.intel.com/products/motherboard/DQ57TM/index.htm</a>
Desktop Board Support	<a href="http://www.intel.com/support/motherboards/desktop">http://www.intel.com/support/motherboards/desktop</a>
Available configurations for the Intel Desktop Board DQ57TM	<a href="http://www.intel.com/products/motherboard/DQ57TM/index.htm">http://www.intel.com/products/motherboard/DQ57TM/index.htm</a>
Supported processors	<a href="http://processormatch.intel.com">http://processormatch.intel.com</a>
Chipset information	<a href="http://www.intel.com/products/desktop/chipsets/index.htm">http://www.intel.com/products/desktop/chipsets/index.htm</a>
BIOS and driver updates	<a href="http://downloadcenter.intel.com">http://downloadcenter.intel.com</a>
Tested memory	<a href="http://www.intel.com/support/motherboards/desktop/sb/CS-025414.htm">http://www.intel.com/support/motherboards/desktop/sb/CS-025414.htm</a>
Integration information	<a href="http://www.intel.com/support/go/buildit">http://www.intel.com/support/go/buildit</a>

## 1.4 Processor

The board is designed to support the Intel Core i7, Intel Core i5, Intel Core i3, Intel Pentium processors, and Intel Xeon processor 3400 series in an LGA1156 socket.

Other processors may be supported in the future. This board is designed to support processors with a maximum TDP of 95 W. See the Intel web site listed below for the most up-to-date list of supported processors.

For information about...	Refer to:
Supported processors	<a href="http://processormatch.intel.com">http://processormatch.intel.com</a>



### CAUTION

*Use only the processors listed on the web site above. Use of unsupported processors can damage the board, the processor, and the power supply.*



### NOTE

*This board has specific requirements for providing power to the processor. Refer to Section 2.6.1 on page 60 for information on power supply requirements for this board.*

## 1.5 Intel® Q57 Express Chipset

The Intel Q57 Express Chipset consisting of the Intel Q57 Platform Controller Hub (PCH) provides interfaces to the processor and the USB, SATA, LPC, audio, network, display, Conventional PCI, and PCI Express x1 interfaces. The PCH is a centralized controller for the board's I/O paths.

For information about	Refer to
The Intel Q57 Express chipset	<a href="http://www.intel.com/products/desktop/chipsets/index.htm">http://www.intel.com/products/desktop/chipsets/index.htm</a>
Resources used by the chipset	Chapter 2

## 1.6 System Memory

The board has four DIMM sockets and supports the following memory features:

- Two independent memory channels with interleaved mode support
- Support for non-ECC, unbuffered, single-sided or double-sided DIMMs with x8 organization
- Support for unbuffered ECC memory when used with an Intel Xeon processor 3400 series
- 16 GB maximum total system memory (with 2 Gb memory technology). Refer to Section 2.1.1 on page 43 for information on the total amount of addressable memory.
- Minimum total system memory: 1 GB using 1 Gb x8 module
- Serial Presence Detect
- DDR3 1333 MHz and DDR3 1066 MHz SDRAM DIMMs



### NOTE

*To be fully compliant with all applicable DDR SDRAM memory specifications, the board should be populated with DIMMs that support the Serial Presence Detect (SPD) data structure. This allows the BIOS to read the SPD data and program the chipset to accurately configure memory settings for optimum performance. If non-SPD memory is installed, the BIOS will attempt to correctly configure the memory settings, but performance and reliability may be impacted or the DIMMs may not function under the determined frequency.*

Table 3 lists the supported DIMM configurations.

**Table 3. Supported Memory Configurations**

DIMM Capacity	Configuration (Note)	SDRAM Density	SDRAM Organization Front-side/Back-side	Number of SDRAM Devices
1024 MB	SS	1 Gbit	1 Gb x8/empty	8
2048 MB	DS	1 Gbit	1 Gb x8/1 Gb x8	16
2048 MB	SS	2 Gbit	2 Gb x8/empty	8
4096 MB	DS	2 Gbit	2 Gb x8/2 Gb x8	16

Note: "DS" refers to double-sided memory modules (containing two rows of SDRAM) and "SS" refers to single-sided memory modules (containing one row of SDRAM).

**For information about...**

**Refer to:**

Tested Memory

<http://www.intel.com/support/motherboards/desktop/sb/CS-025414.htm>

---

## 1.6.1 Memory Configurations

The Intel Core i7, Intel Core i5, Intel Core i3, Intel Pentium processors, and Intel Xeon processors 3400 series support the following types of memory organization:

- **Dual channel (Interleaved) mode.** This mode offers the highest throughput for real world applications. Dual channel mode is enabled when the installed memory capacities of both DIMM channels are equal. Technology and device width can vary from one channel to the other but the installed memory capacity for each channel must be equal. If different speed DIMMs are used between channels, the slowest memory timing will be used.
- **Single channel (Asymmetric) mode.** This mode is equivalent to single channel bandwidth operation for real world applications. This mode is used when only a single DIMM is installed or the memory capacities are unequal. Technology and device width can vary from one channel to the other. If different speed DIMMs are used between channels, the slowest memory timing will be used.

**For information about...**

**Refer to:**

Memory Configuration examples

<http://www.intel.com/support/motherboards/desktop/sb/cs-011965.htm>

---



Figure 3 illustrates the memory channel and DIMM configuration.

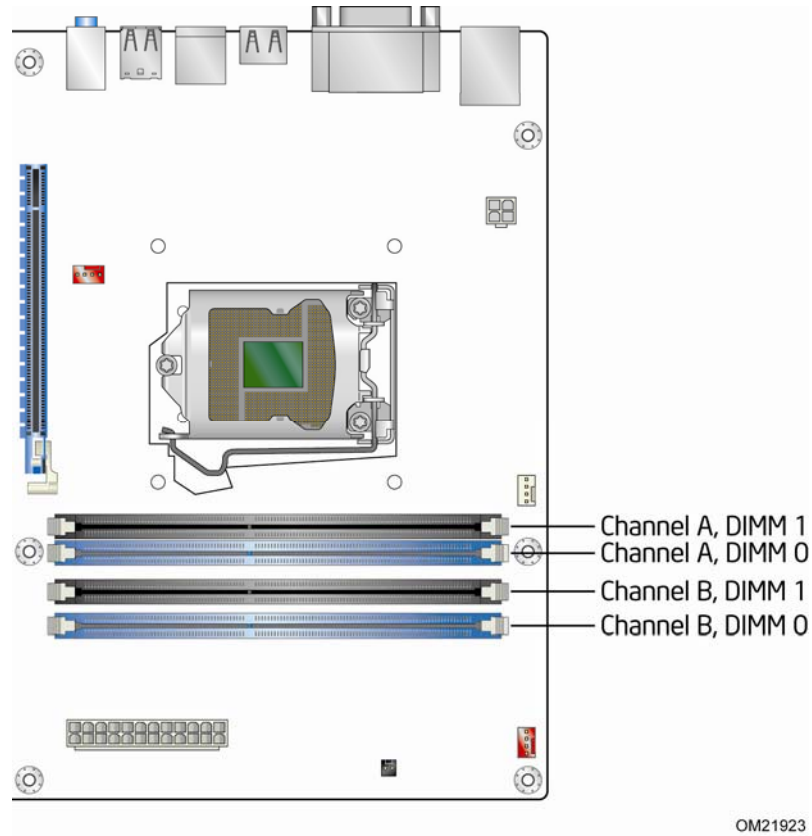

**Figure 3. Memory Channel and DIMM Configuration**



**NOTE**

*When using a processor without Intel Graphics Technology, there must always be memory installed into any or both of the DIMM 0 (blue) memory sockets for the system to boot.*

## 1.7 Graphics Subsystem

The board supports system graphics through either Intel Graphics Technology or a PCI Express 2.0 x16 add-in graphics card.

### 1.7.1 Integrated Graphics

The board supports integrated graphics through the Intel® Flexible Display Interface (Intel® FDI) for processors with Intel Graphics Technology.



#### NOTE

If using a processor with integrated graphics, the board will support only two of the integrated graphics interfaces simultaneously: DisplayPort, DVI-I, DVI-D. Also, during the Power On Self Test (POST), the board will not output to the DisplayPort if DVI-I or DVI-D is used concurrently with DisplayPort.

#### 1.7.1.1 DisplayPort\*

DisplayPort is a digital communication interface that utilizes differential signaling to achieve a high bandwidth bus interface designed to support connections between PCs and monitors, projectors, and TV displays. DisplayPort is suitable for display connections between consumer electronics devices such as high definition optical disc players, set top boxes, and TV displays. DisplayPort output can also be converted to High-Definition Multimedia Interface\* (HDMI\*) using a DisplayPort-HDMI converter.

DisplayPort's maximum supported display resolution is 2560 x 1600 at 60 Hz refresh with a 16:10 aspect ratio (WQXGA). DisplayPort 1.1 adds support for High Bandwidth Digital Content Protection (HDCP) version 1.3. HDCP support enables viewing of protected content from Blu-ray Disc\* and HD-DVD optical media over DisplayPort 1.1 connections.

---

<b>For information about</b>	<b>Refer to</b>
------------------------------	-----------------

DisplayPort technology

<http://www.displayport.org>

---

#### 1.7.1.2 Digital Visual Interface (DVI)

The DVI-I port supports both digital and analog DVI displays. The maximum supported resolution is 2048 x 1536 at 75 Hz refresh (QXGA). The DVI port is compliant with the DVI 1.0 specification. DVI analog output can also be converted to VGA using a DVI-VGA converter.

The DVI-D port supports only digital DVI displays. The maximum supported resolution is 2048 x 1536 at 75 Hz refresh (QXGA). The DVI-D port is compliant with the DVI 1.0 specification.

## 1.7.2 PCI Express x16 Graphics

The Intel Core i7, Intel Core i5, Intel Core i3, Intel Pentium processors, and Intel Xeon processors 3400 series in an LGA1156 socket support discrete add in graphics cards through the PCI Express 2.0 x16 graphics connector:

- Supports PCI Express GEN2 frequency of 2.5 GHz resulting in 5.0 Gb/s each direction (500 MB/s) per lane. Maximum theoretical bandwidth on interface is 8 GB/s in each direction, simultaneously, when operating in x16 mode.
- Supports PCI Express GEN1 frequency of 1.25 GHz resulting in 2.5 Gb/s each direction (250 MB/s) per lane. Maximum theoretical bandwidth on interface is 4 GB/s in each direction, simultaneously, when operating in x16 mode.

<b>For information about</b>	<b>Refer to</b>
PCI Express technology	<a href="http://www.pcisig.com">http://www.pcisig.com</a>

## 1.8 USB

The board supports up to fourteen USB 2.0 ports through two EHCI host controllers on the PCH that allow the use of EHCI-compatible drivers.

The port arrangement is as follows:

- Six ports are implemented with stacked back panel connectors
- Eight front panel ports are implemented through four dual-port internal headers

<b>For information about</b>	<b>Refer to</b>
The location of the USB connectors on the back panel	Figure 10, page 46
The location of the front panel USB headers	Figure 11, page 47

## 1.9 SATA Interfaces

The board provides six SATA connectors through the PCH, which support one device per connector:

- Four internal SATA connectors (black)
- One internal eSATA connector (red) for internal or external connectivity
- One eSATA connector (red) on the back panel for external connectivity

The PCH provides independent SATA ports with a theoretical maximum transfer rate of 3 Gb/s per port. A point-to-point interface is used for host to device connections.

The underlying SATA functionality is transparent to the operating system. The SATA controller can operate in both legacy and native modes. In legacy mode, standard IDE I/O and IRQ resources are assigned (IRQ 14 and 15). In Native mode, standard PCI Conventional bus resource steering is used. Native mode is the preferred mode for configurations using the Windows\* XP, Windows Vista\*, and Windows 7\* operating systems.

For more information, see: <http://www.serialata.org/>.

For information about	Refer to
The location of the SATA connectors	Figure 11, page 47

### 1.9.1.1 Serial ATA RAID

The board supports the Intel Rapid Storage Technology (Intel RST) which provides the following RAID (Redundant Array of Independent Drives) levels:

- **RAID 0** - data striping
- **RAID 1** - data mirroring
- **RAID 0+1 (or RAID 10)** - data striping and mirroring
- **RAID 5** - distributed parity

### 1.9.1.2 Intel® Rapid Recover Technology

The board incorporates the Intel® Rapid Recover Technology (Intel® RRT). Intel Rapid Recover Technology is a feature of Intel Rapid Storage Technology. It uses RAID 1 (mirroring) functionality to copy data from a designated master drive to a designated recovery drive. The master drive data can be copied to the recovery drive either continuously or on request.

When using the continuous update policy, changes made to the data on the master drive while the recovery drive is disconnected or offline are automatically copied to the recovery drive when it is reconnected. When using the on request update policy, the master drive data can be restored to a previous state by copying the data on the recovery drive back to the master drive.

For information about	Refer to
Intel Rapid Recovery Technology	<a href="http://www.intel.com/support/chipsets/imsm/sb/CS-026142.htm">http://www.intel.com/support/chipsets/imsm/sb/CS-026142.htm</a>

## 1.10 Legacy I/O Controller

The Legacy I/O Controller provides the following features:

- One serial port
- Serial IRQ interface compatible with serialized IRQ support for PCI Conventional bus systems
- Intelligent power management, including a programmable wake-up event interface
- PCI Conventional bus power management support

The BIOS Setup program provides configuration options for the Legacy I/O controller.

### 1.10.1 Serial Port

The serial port is implemented as a 10-pin header on the board. The serial port supports data transfers at speeds up to 115.2 kbits/s with BIOS support.

<b>For information about</b>	<b>Refer to</b>
The location of the serial port header	Figure 11, page 47

## 1.11 Audio Subsystem

The board supports Intel High Definition Audio through the Realtek ALC662-VC audio codec as well as the DisplayPort interface.

The Realtek ALC662-VC-based audio subsystem supports the following features:

- 6-channel audio with independent multi-streaming stereo.
- Advanced jack sense for the back panel audio jacks that enables the audio codec to recognize the device that is connected to an audio port. The back panel audio jacks are capable of retasking according to the user's definition, or can be automatically switched depending on the recognized device type.
- Stereo input and output through back panel jacks
- Headphone and Mic in functions for front panel audio jacks
- S/PDIF audio header
- A signal-to-noise (S/N) ratio of 90 dB

### 1.11.1 Audio Subsystem Software

Audio software and drivers are available from Intel's World Wide Web site.

<b>For information about</b>	<b>Refer to</b>
Obtaining audio software and drivers	Section 1.3, page 14

### 1.11.2 Audio Headers and Connectors

The board contains audio connectors and headers on both the back panel and the component side of the board. The component-side audio headers include the following:

- Front panel audio (a 2 x 5-pin header that provides headphone and mic in signals for front panel audio connectors) (yellow)
- S/PDIF audio header (1 x 4-pin header) (yellow)
- Internal mono speaker header (1 x 2-pin header) (yellow)

For information about	Refer to
The locations of the front panel audio header, S/PDIF header, and internal mono speaker header	Figure 11, page 47
The signal names of the front panel audio header	Table 14 and Table 15, page 49
The signal names of the S/PDIF header	Table 12, page 49
The signal names of the internal mono speaker header	Table 13, page 49
The back panel audio connectors	Section 2.2.1, page 46

#### 1.11.2.1 Analog Audio Connectors

The available configurable back panel audio connectors are shown in Figure 4.

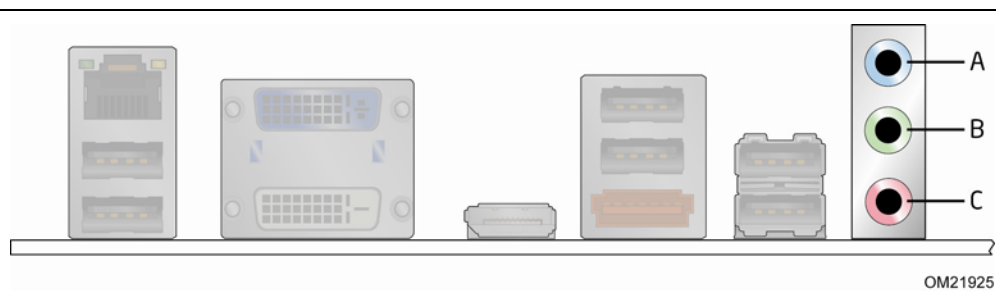

Item	Description
A	Audio line in
B	Audio line out
C	Mic in

**Figure 4. Back Panel Audio Connector Options**

The back panel audio connectors are configurable through the audio device drivers.

For information about	Refer to
The back panel audio connectors	Section 2.2.1, page 46

The front panel headphone output is supported using a separate audio channel pair allowing multi-streaming audio configurations such as simultaneous 5.1 surround playback and stereo audio conferencing (through back panel speakers and a front panel headset, respectively).

### 1.11.2.2 S/PDIF Header

The S/PDIF header allows connections to coaxial or optical dongles for digital audio output.

### 1.11.2.3 Internal Mono Speaker Header

The internal mono speaker header allows connection to an internal, low-power speaker for basic system sound capability. The subsystem is capable of driving a speaker load of 8 Ohms at 1 W (rms) or 4 Ohms at 1.5 W (rms).

## 1.12 LAN Subsystem

The LAN subsystem consists of the following:

- Intel 82578DM Gigabit Ethernet Controller (10/100/1000 Mbits/s)
- RJ-45 LAN connector with integrated status LEDs

For information about	Refer to
LAN software and drivers	<a href="http://downloadcenter.intel.com">http://downloadcenter.intel.com</a>

### 1.12.1 Intel® 82578DM Gigabit Ethernet Controller

The Intel 82578DM Gigabit Ethernet Controller supports the following features:

- 10/100/1000 BASE-T IEEE 802.3 compliant
- PCI Express link
- Compliant to IEEE 802.3x flow control support
- 802.1p and 802.1q
- TCP, IP, and UDP checksum offload (for IPv4 and IPv6)
- Transmit TCP segmentation
- Full device driver compatibility
- PCI Express power management support
- Intel AMT 6.0

### 1.12.2 LAN Subsystem Software

LAN software and drivers are available from Intel's World Wide Web site.

For information about	Refer to
Obtaining LAN software and drivers	<a href="http://downloadcenter.intel.com">http://downloadcenter.intel.com</a>

### 1.12.3 RJ-45 LAN Connector with Integrated LEDs

Two LEDs are built into the RJ-45 LAN connector (shown in Figure 5).

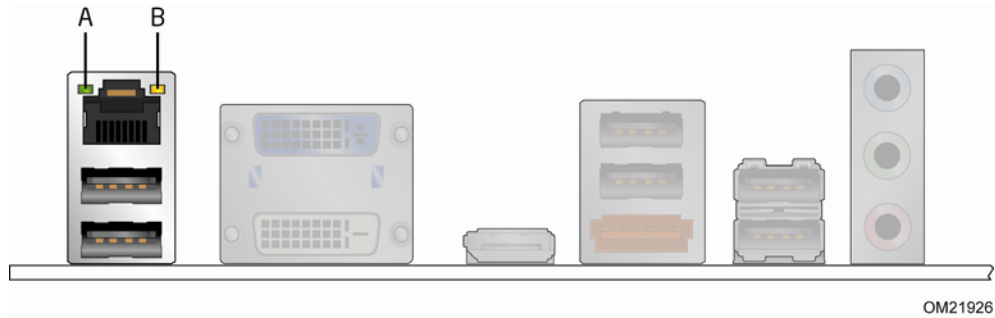

Item	Description
A	Link/Activity LED (green)
B	Link Speed LED (green/yellow)

**Figure 5. LAN Connector LED Locations**

Table 4 describes the LED states when the board is powered up and the LAN subsystem is operating.

**Table 4. LAN Connector LED States**

LED	LED Color	LED State	Condition
Link/Activity	Green	Off	LAN link is not established.
		On	LAN link is established.
		Blinking	LAN activity is occurring.
Link Speed	Green/Yellow	Off	10 Mbits/s data rate is selected or negotiated.
		Green	100 Mbits/s data rate is selected or negotiated.
		Yellow	1000 Mbits/s data rate is selected or negotiated.



## 1.13 Real-Time Clock Subsystem

A coin-cell battery (CR2032) powers the real-time clock and CMOS memory. When the computer is not plugged into a wall socket, the battery has an estimated life of three years. When the computer is plugged in, the standby current from the power supply extends the life of the battery.

The clock is accurate to  $\pm 13$  minutes/year at 25 °C with power applied through the power supply 5V STBY rail.



### **NOTE**

*If the battery and AC power fail date and time values will be reset and the user will be notified during POST.*

When the voltage drops below a certain level, the BIOS Setup program settings stored in CMOS RAM (for example, the date and time) might not be accurate. Replace the battery with an equivalent one. Figure 1 on page 11 shows the location of the battery.

## 1.14 Thermal Monitoring

Figure 6 shows the locations of the thermal sensors and fan headers.

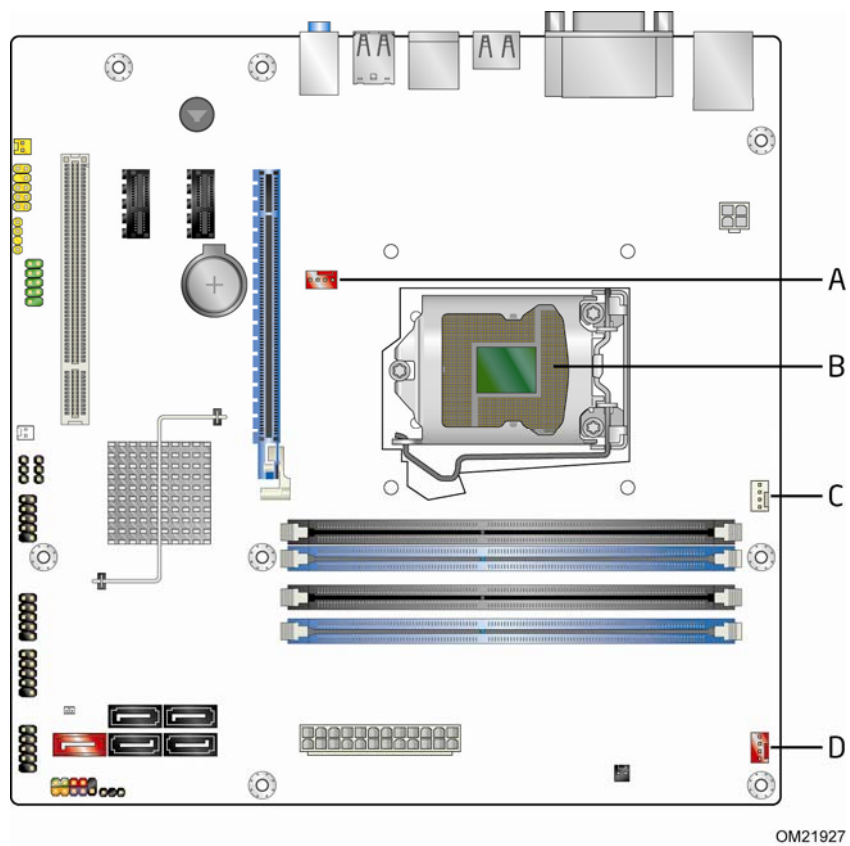

Item	Description
A	Rear chassis fan header
B	Thermal diode, located on processor die
C	Processor fan header
D	Front chassis fan header

**Figure 6. Thermal Sensors and Fan Headers**

## 1.15 Platform Management and Security

In addition to Intel AMT the Intel DQ57TM Desktop Board integrates several functions designed to manage the system and lower the total cost of ownership (TCO) of the system. These system management functions are designed to report errors, diagnose the system, and recover from system lockups without the aid of an external microcontroller.

### 1.15.1 Hardware Management Subsystem

The hardware management features enable the board to be compatible with the Wired for Management (WfM) specification. The board has several hardware management features, including the following:

- Fan monitoring and control
- Thermal and voltage monitoring
- Chassis intrusion detection

#### 1.15.1.1 Hardware Monitoring and Fan Control

The features of the hardware monitoring and fan control include:

- Intel Quiet System Technology, delivering acoustically-optimized thermal management
- Thermal sensors in the processor and PCH, as well as near the CPU voltage regulators and system memory
- Monitoring of five system voltages (+5 V, +12 V, +3.3 V, Memory V-SM and +VCCP) to detect levels above or below acceptable values
- Thermally monitored closed-loop fan control for all three fans that can adjust fan speed as needed

#### 1.15.1.2 Fan Monitoring

Fan monitoring can be observed through the BIOS setup user interface, Intel® Desktop Utilities or third-party software.

For information about	Refer to
The functions of the fan headers	Section 1.16.2.2, page 38

#### 1.15.1.3 Chassis Intrusion and Detection

The board supports a chassis security feature that detects if the chassis cover is removed. The security feature uses a mechanical switch on the chassis that attaches to the chassis intrusion header. When the chassis cover is removed, the mechanical switch is in the closed position.

For information about	Refer to
The location of the chassis intrusion header	Figure 11, page 47

## 1.15.2 Intel® vPro™ Technology

Intel® vPro™ Technology is a set of processor and platform capabilities designed to enable greater proactive security, enhanced maintenance, and improved remote management both inside and outside the corporate firewall. These include:

- Intel Active Management Technology (Intel AMT)
- Intel Virtualization Technology (Intel VT)
- Intel Trusted Execution Technology (Intel TXT)
- Intel Virtualization Technology for Directed I/O (Intel VT-d)
- Intel Remote PC Assist (Intel RPAT) / Intel Fast Call for Help
- Trusted Platform Module (TPM)

### 1.15.2.1 Intel® Active Management Technology (Intel® AMT)

Intel Active Management Technology (Intel AMT) offers IT organizations tamper-resistant and persistent management capabilities. Specifically, Intel AMT is a hardware-based solution that uses out of band communication to manage access to client systems in addition to offering encrypted and persistent asset management and remote diagnostics and/or recovery capabilities for networked platforms. With Intel AMT, IT organizations can easily get accurate platform information, and can perform remote updating, diagnostics, debugging and repair of a system, regardless of the state of the operating system or the power state of the system.

The Intel Active Management Technology subsystem consists of:

- Intel ME microcontroller embedded in the Intel Q57 PCH
- Intel 82578DM Gigabit (10/100/1000 Mbits/s) Ethernet LAN controller
- BIOS/SPI Flash (64 Mbits)
- On-board Intel ME “M” state status LED



#### **NOTE**

*Software with AMT capability is required to take advantage of Intel AMT platform management capabilities.*

#### 1.15.2.1.1 Intel AMT Features

The key features of Intel AMT include:

- Secure Out of Band (OOB) system management that allows remote management of PCs regardless of system power or operating system state.
  - SSL 3.1/TLS encryption
  - HTTP authentication
  - TCP/IP
  - HTTP web GUI
  - XML/SOAP API
  - Web Services for Management (WS-MAN) protocol support

- Remote troubleshooting and recovery that can significantly reduce desk-side visits and potentially increasing efficiency of IT technical staff.
  - System event log
  - IDE Redirection (IDE-R) or PXE boot: remote CD or network drive boot
  - Serial over LAN
  - OOB diagnostics
  - Remote control
  - Operating system repair
- Proactive alerting that decreases downtime and minimizes time to repair.
  - Programmable policies
  - Operating system lock-up alert
  - Boot failure alert
  - Hardware failure alerts
- Third party non-volatile storage that prevents users from removing critical inventory, remote control, or virus protection agents.
  - Nonvolatile storage for agents
  - Tamper-resistant
- Remote hardware and software asset tracking that eliminates time-consuming manual inventory tracking, which also reduces asset accounting costs.
  - E-Asset Tag
  - HW/SW inventory
- System Defense 2. In addition to the in-bound and out-bound packet filtering of the previous generation, System Defense 2 is an Intel AMT feature that uses advanced heuristics to help protect against the propagation of worms through the use of preset packet filters. The number of new connections made to a specific port or IP address are counted over a specific time window. If a preset threshold is exceeded, it will alert the Management Console and suspend the client's network activity until the system can be remediated.
- Remote Configuration (RCFG) minimizes the cost to deploy Intel AMT by eliminating the need for IT personnel to touch each client system prior to configuration. Remote Configuration consists of a single OEM BIOS/Firmware image that provides the Intel AMT client with information to authenticate connections and allows it to remotely perform a secure setup procedure. IT departments must acquire an appropriate Intel AMT-trusted certificate as well as use a remote management application that supports Remote Configuration. Remote Configuration also requires the use of automatic IP addressing (DHCP).

- KVM (Keyboard-Video-Mouse) Redirection allows an IT administrator to remotely control a user’s keyboard without having to rely on third-party software applications. The user retains the ability to allow or discontinue the remote access through on-screen pop-up windows.



**NOTE**

*KVM Redirection requires the use of an Intel® processor with integrated graphics.*

- PC Alarm Clock can wake the PC at scheduled times to run resource-intensive tasks during off hours, improving security and performance of the platform.

For information about	Refer to
Intel Active Management Technology (Intel AMT)	<a href="http://www.intel.com/technology/platform-technology/intel-amt/index.htm">http://www.intel.com/technology/platform-technology/intel-amt/index.htm</a>

**1.15.2.1.2 Intel AMT Software and Drivers**

Intel AMT software and drivers are available from Intel’s World Wide Web site. The package usually consists of the following components:

- Intel® Management Engine Interface (Intel® ME Interface)
- Serial Over LAN (SOL) driver
- Local Manageability Service (LMS)
- User Notification Service (UNS)
- Intel® ME WMI provider
- Intel® Active Management Technology NAC Posture Plug-in
- Intel® Control Center
- Intel® Management and Security Status Application
- Intel® Remote PC Assist Technology Client Agent

For information about	Refer to
Obtaining Intel AMT software and drivers	Section 1.3, page 14

**1.15.2.1.3 Intel ME “M” State LED**

The board has a red-colored Intel ME “M” state LED (see Figure 7). The “M” state is based on Intel ME status, as follows:

- M0 = Intel ME is in full control in S0
- M3 = Intel ME is in full control in S3-S5 for “out of bound” Intel manageability
- Moff = Intel ME is in sleep state after Intel ME timeout has occurred

Table 5 shows expected behavior of the “M” state LED.

**Table 5. Intel ME “M” State LED Behavior**

Sx/M3	Sx/Moff	S0/M0
LED blinks	Off	On

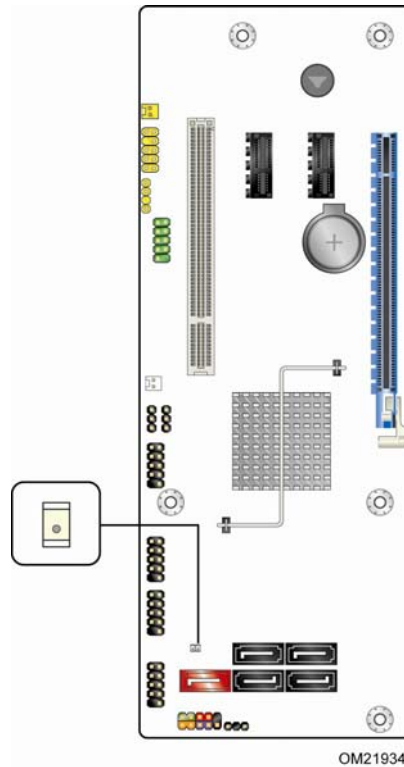

**Figure 7. Location of the Intel ME "M" State LED**

### 1.15.2.2 Intel® Virtualization Technology (Intel® VT)

Intel Virtualization Technology (Intel VT) is a processor technology that enables a platform to run multiple operating systems and applications as independent machines, allowing one computer system to function as multiple "virtual" systems. It also provides the "assisted hardware virtualization" required by some operating systems for backward compatibility, such as Windows XP Mode for Windows 7.



#### **NOTE**

*Requires an Intel processor that supports Intel VT.*

### 1.15.2.3 Intel® Trusted Execution Technology (Intel® TXT)

Intel Trusted Execution Technology (Intel TXT) helps protect the platform against software-based attacks and preserves the confidentiality and integrity of the data created and stored on the system. It accomplishes this by using a measured launch and leveraging Intel VT to produce a protected environment for the execution of sensitive applications.



#### **NOTE**

*Requires an Intel processor that supports Intel TXT.*

### 1.15.2.4 Intel® Virtualization Technology for Directed I/O (Intel® VT-d)

Intel Virtualization Technology for Directed I/O (Intel VT-d) compliments Intel VT by providing the ability to isolate and restrict device accesses to the resources owned by the virtual partition managing the device.



#### **NOTE**

*Requires an Intel processor that supports Intel VT.*

### 1.15.2.5 Intel® Remote PC Assist (Intel® RPAT) and Intel® Fast Call for Help

Intel Remote PC Assist (Intel RPAT) provides a means for on-demand, reactive maintenance for small and medium businesses. Out of band, it is activated by pressing function key <F9> during the system's Power On Self Test (POST). Optionally, an integrator may choose to supply an external button connected to the RPAT header that will serve the same function. To utilize Intel RPAT technology from the desktop requires the installation of the Intel RPAT Client Agent, available for download from Intel's World Wide Web site.

Intel Fast Call for Help supplies remote maintenance connectivity for the Enterprise user inside or outside the corporate firewall. Coupled with your enterprise's Management Presence Server, it provides both reactive and proactive maintenance. Inside the firewall, this feature adapts Client Initiated Local Access (CILA); outside the firewall it uses Client Initiated Remote Access (CIRA). This service is triggered in the same manner as Intel RPAT.

Many of the features of Intel AMT are available with Intel RPAT and Intel Fast Call for Help. These include Serial-over-LAN, IDE Redirection, KVM Redirection and PC Alarm Clock.



#### **NOTE**

*Intel Remote PC Assist Technology requires a vPro technology-enabled computer that has an Intel Remote PC Assist Technology-enabled BIOS, a connection with a power source and the Internet. This service operates via a wired LAN connection only and requires a direct Internet connection (no proxy server) with the ability to connect to external Internet locations (locations outside the local network). A remote service provider supporting the Intel Remote PC Assist Technology must be used to perform remote management. The Intel® Remote PC Assist Wizard application and third party remote management software tools supporting Intel Remote PC Assist Technology must be deployed on the target computer running one of the supported operating systems in order to perform remote management operations. Use of the technology may require configuration by the purchaser. Intel Remote PC Assist Technology is not available in all geographies or on all computer systems.*

<b>For information about</b>	<b>Refer to</b>
The location of the Intel RPAT header	Figure 11, page 47
Intel Remote PC Assist Technology	<a href="http://www.intel.com/technology/product/remotepcassist.htm">http://www.intel.com/technology/product/remotepcassist.htm</a>



### 1.15.2.6 Trusted Platform Module (TPM)

The Nuvoton WPCT210 TPM version 1.2 revision 103 component is specifically designed to enhance platform security above-and-beyond the capabilities of today's software by providing a protected space for key operations and other security critical tasks. Using both hardware and software, the TPM protects encryption and signature keys at their most vulnerable stages—operations when the keys are being used unencrypted in plain-text form. The TPM is specifically designed to shield unencrypted keys and platform authentication information from software-based attacks.

For information about	Refer to
Nuvoton TPM version 1.2	<a href="http://www.nuvoton-usa.com/">http://www.nuvoton-usa.com/</a>

## 1.16 Power Management

Power management is implemented at several levels, including:

- Software support through Advanced Configuration and Power Interface (ACPI)
- Hardware support:
  - Power connector
  - Fan headers
  - LAN wake capabilities
  - Instantly Available PC technology
  - Wake from USB
  - Power Management Event signal (PME#) wake-up support
  - PCI Express WAKE# signal support
  - Wake from serial port

## 1.16.1 ACPI

ACPI gives the operating system direct control over the power management and Plug and Play functions of a computer. The use of ACPI with this board requires an operating system that provides full ACPI support. ACPI features include:

- Plug and Play (including bus and device enumeration)
- Power management control of individual devices, add-in boards (some add-in boards may require an ACPI-aware driver), video displays, and hard disk drives
- Methods for achieving less than 15-watt system operation in the power-on/standby sleeping state
- A Soft-off feature that enables the operating system to power-off the computer
- Support for multiple wake-up events (see Table 8 on page 36)
- Support for a front panel power and sleep mode switch

Table 6 lists the system states based on how long the power switch is pressed, depending on how ACPI is configured with an ACPI-aware operating system.

**Table 6. Effects of Pressing the Power Switch**

<b>If the system is in this state...</b>	<b>...and the power switch is pressed for</b>	<b>...the system enters this state</b>
Off (ACPI G2/G5 – Soft off)	Less than four seconds	Power-on (ACPI G0 – working state)
On (ACPI G0 – working state)	Less than four seconds	Soft-off/Standby (note) (ACPI G1 – sleeping state)
On (ACPI G0 – working state)	More than six seconds	Fail safe power-off (ACPI G2/G5 – Soft off)
Sleep (ACPI G1 – sleeping state)	Less than four seconds	Wake-up (ACPI G0 – working state)
Sleep (ACPI G1 – sleeping state)	More than six seconds	Power-off (ACPI G2/G5 – Soft off)

Note: System can only enter Standby state if power switch action is properly configured by the operating system.

### 1.16.1.1 System States and Power States

Under ACPI, the operating system directs all system and device power state transitions. The operating system puts devices in and out of low-power states based on user preferences and knowledge of how devices are being used by applications. Devices that are not being used can be turned off. The operating system uses information from applications and user settings to put the system as a whole into a low-power state.

Table 7 lists the power states supported by the board along with the associated system power targets. See the ACPI specification for a complete description of the various system and power states.

**Table 7. Power States and Targeted System Power**

<b>Global States</b>	<b>Sleeping States</b>	<b>Processor States</b>	<b>Device States</b>	<b>Targeted System Power</b> (Note 1)
G0 – working state	S0 – working	C0 – working	D0 – working state.	Full power > 30 W
G1 – sleeping state	S1 – Processor stopped	C1 – stop grant	D1, D2, D3 – device specification specific.	5 W < power < 52.5 W
G1 – sleeping state	S3 – Suspend to RAM. Context saved to RAM.	No power	D3 – no power except for wake-up logic.	Power < 5 W (Note 2)
G1 – sleeping state	S4 – Suspend to disk. Context saved to disk.	No power	D3 – no power except for wake-up logic.	Power < 5 W (Note 2)
G2/S5	S5 – Soft off. Context not saved. Cold boot is required.	No power	D3 – no power except for wake-up logic.	Power < 5 W (Note 2)
G3 – mechanical off AC power is disconnected from the computer.	No power to the system.	No power	D3 – no power for wake-up logic, except when provided by battery or external source.	No power to the system. Service can be performed safely.

Notes:

1. Total system power is dependent on the system configuration, including add-in boards and peripherals powered by the system chassis' power supply.
2. Dependent on the standby power consumption of wake-up devices used in the system.

### 1.16.1.2 Wake-up Devices and Events

Table 8 lists the devices or specific events that can wake the computer from specific states.

**Table 8. Wake-up Devices and Events**

These devices/events can wake up the computer...	...from this state
Power switch	S1, S3, S4, S5
RTC alarm	S1, S3, S4, S5
LAN	S1, S3, S4, S5
USB	S1, S3
PME# signal	S1, S3, S4, S5
WAKE# signal	S1, S3, S4, S5
Serial port	S1, S3

Notes:

- S4 implies operating system support only.
- USB ports are turned off during S4/S5 states.



#### **NOTE**

*The use of these wake-up events from an ACPI state requires an operating system that provides full ACPI support. In addition, software, drivers, and peripherals must fully support ACPI wake events.*

## 1.16.2 Hardware Support



### CAUTION

*Ensure that the power supply provides adequate +5 V standby current if LAN wake capabilities and Instantly Available PC technology features are used. Failure to do so can damage the power supply. The total amount of standby current required depends on the wake devices supported and manufacturing options.*

The board provides several power management hardware features, including:

- Power connector
- Fan headers
- LAN wake capabilities
- Instantly Available PC technology
- Wake from USB
- PME# signal wake-up support
- WAKE# signal wake-up support
- Wake from serial port
- +5 V Standby Power Indicator LED

LAN wake capabilities and Instantly Available PC technology require power from the +5 V standby line.



### NOTE

*The use of Wake from USB from an ACPI state requires an operating system that provides full ACPI support.*

#### 1.16.2.1 Power Connector

ATX12V-compliant power supplies can turn off the system power through system control. When an ACPI-enabled system receives the correct command, the power supply removes all non-standby voltages.

When resuming from an AC power failure, the computer returns to the power state it was in before power was interrupted (on or off). The computer's response can be set using the Last Power State feature in the BIOS Setup program's Boot menu.

#### For information about

#### Refer to

---

The location of the main power connector

Figure 11, page 47

---

The signal names of the main power connector

Table 23, page 52

---

### 1.16.2.2 Fan Headers

The function/operation of the fan headers is as follows:

- The fans are on when the board is in the S0 or S1 state
- The fans are off when the board is in the S3, S4, or S5 state
- Each fan header is wired to a fan tachometer input of the hardware monitoring and fan control ASIC
- All fan headers support closed-loop fan control that can adjust the fan speed or switch the fan on or off as needed
- All fan headers have a +12 V DC connection
- 4-pin fan headers are controlled by Pulse Width Modulation
- The front fan and rear fan headers also support linear fan control on 3-wire fans

For information about	Refer to
The location of the fan headers	Figure 11, page 47
The location of the fan headers and sensors for thermal monitoring	Figure 6, page 26

### 1.16.2.3 LAN Wake Capabilities



#### CAUTION

*For LAN wake capabilities, the +5 V standby line for the power supply must be capable of providing adequate +5 V standby current. Failure to provide adequate standby current when implementing LAN wake capabilities can damage the power supply.*

LAN wake capabilities enable remote wake-up of the computer through a network. The LAN subsystem monitors network traffic at the Media Independent Interface. Upon detecting a Magic Packet\* frame, the LAN subsystem asserts a wake-up signal that powers up the computer.

### 1.16.2.4 Instantly Available PC Technology



#### CAUTION

*For Instantly Available PC technology, the +5 V standby line for the power supply must be capable of providing adequate +5 V standby current. Failure to provide adequate standby current when implementing Instantly Available PC technology can damage the power supply.*

Instantly Available PC technology enables the board to enter the ACPI S3 (Suspend-to-RAM) sleep-state. While in the S3 sleep-state, the computer will appear to be off (the power supply is off and the front panel power LED will behave as configured by the BIOS "S3 State Indicator" option). When signaled by a wake-up device or event, the system quickly returns to its last known wake state. Table 8 on page 36 lists the devices and events that can wake the computer from the S3 state.

The board supports the *PCI Bus Power Management Interface Specification*. Add-in boards that also support this specification can participate in power management and can be used to wake the computer.

The use of Instantly Available PC technology requires operating system support and PCI 2.2 compliant add-in cards, PCI Express add-in cards, and drivers.

### 1.16.2.5 Wake from USB

USB bus activity wakes the computer from ACPI S1 or S3 states.



#### NOTE

*Wake from USB requires the use of a USB peripheral that supports Wake from USB and is supported by the operating system.*

### 1.16.2.6 PME# Signal Wake-up Support

When the PME# signal on the Conventional PCI bus is asserted, the computer wakes from an ACPI S1, S3, S4, or S5 state.

### 1.16.2.7 WAKE# Signal Wake-up Support

When the WAKE# signal on a PCI Express add-in card is asserted, the computer wakes from an ACPI S1, S3, S4, or S5 state.

### 1.16.2.8 Wake from Serial Port

Serial port activity wakes the computer from an ACPI S1 or S3 state.

### 1.16.2.9 +5 V Standby Power LED

The green +5 V standby power indicator LED shows that power is still present even when the computer appears to be off. Figure 8 shows the location of the Standby Power indicator LED on the board.



**CAUTION**

*If AC power has been switched off and the standby power indicators are still lit, disconnect the power cord before installing or removing any devices connected to the board. Failure to do so could damage the board and any attached devices.*

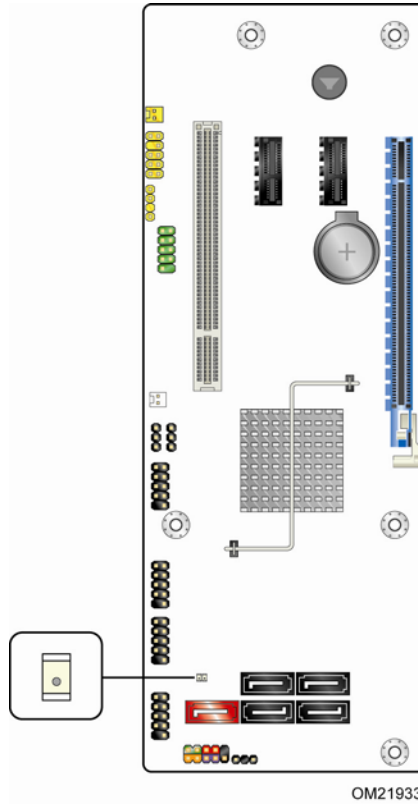

**Figure 8. Location of the Standby Power LED (Green)**



### 1.16.3 ENERGY STAR\* 5.0, e-Standby, and ErP Compliance

The US Department of Energy and the US Environmental Protection Agency have continually revised the ENERGY STAR requirements. Intel has worked directly with these two governmental agencies in the definition of new requirements.

Intel Desktop Board DQ57TM meets the following program requirements in an adequate system configuration, including appropriate selection of an efficient power supply:

- Energy Star v5.0, category A
- EPEAT\*
- Korea e-Standby
- European Union Energy-related Products Directive 2009 (ErP)

<b>For information about</b>	<b>Refer to</b>
ENERGY STAR requirements and recommended configurations	<a href="http://www.intel.com/go/energystar">http://www.intel.com/go/energystar</a>
Electronic Product Environmental Assessment Tool (EPEAT)	<a href="http://www.epeat.net/">http://www.epeat.net/</a>
Korea e-Standby Program	<a href="http://www.kemco.or.kr/new_eng/pg02/pg02100300.asp">http://www.kemco.or.kr/new_eng/pg02/pg02100300.asp</a>
European Union Energy-related Products Directive 2009 (ErP)	<a href="http://ec.europa.eu/enterprise/policies/sustainable-business/sustainable-product-policy/ecodesign/index_en.htm">http://ec.europa.eu/enterprise/policies/sustainable-business/sustainable-product-policy/ecodesign/index_en.htm</a>



## 2 Technical Reference

---

### 2.1 Memory Resources

#### 2.1.1 Addressable Memory

The board utilizes 16 GB of addressable system memory. Typically the address space that is allocated for PCI Conventional bus add-in cards, PCI Express configuration space, BIOS (SPI Flash device), and chipset overhead resides above the top of DRAM (total system memory). On a system that has 16 GB of system memory installed, it is not possible to use all of the installed memory due to system address space being allocated for other system critical functions. These functions include the following:

- BIOS/SPI Flash device (64 Mbit)
- Local APIC (19 MB)
- Direct Media Interface (40 MB)
- Front side bus interrupts (17 MB)
- PCI Express configuration space (256 MB)
- PCH base address registers PCI Express ports (up to 256 MB)
- Memory-mapped I/O that is dynamically allocated for PCI Conventional and PCI Express add-in cards (256 MB)

The board provides the capability to reclaim the physical memory overlapped by the memory mapped I/O logical address space. The board remaps physical memory from the top of usable DRAM boundary to the 4 GB boundary to an equivalent sized logical address range located just above the 4 GB boundary. Figure 9 shows a schematic of the system memory map. All installed system memory can be used when there is no overlap of system addresses.

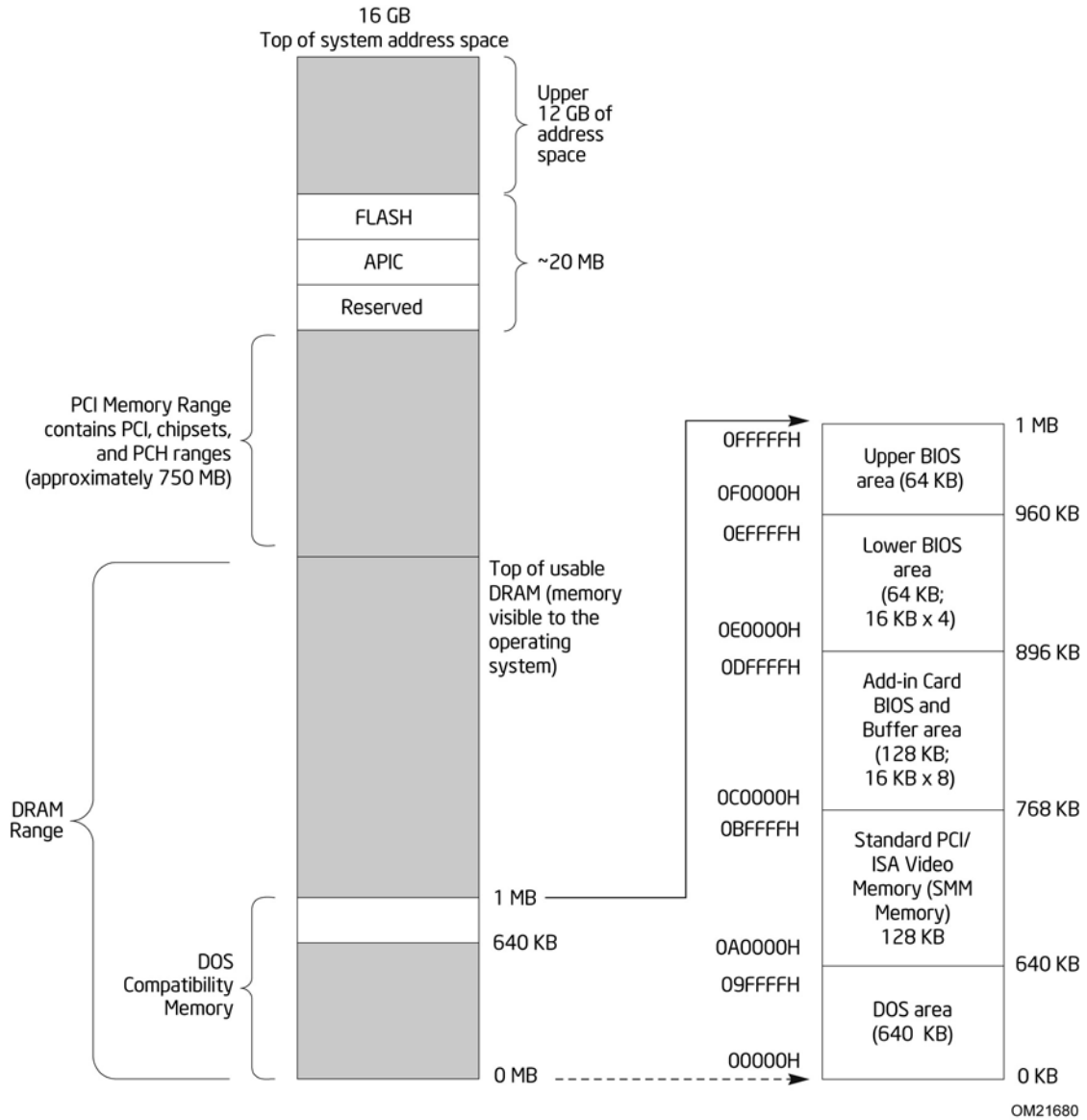

Figure 9. Detailed System Memory Address Map

## 2.1.2 Memory Map

Table 9 lists the system memory map.

**Table 9. System Memory Map**

Address Range (decimal)	Address Range (hex)	Size	Description
1024 K - 16777216 K	100000 - 3FFFFFFF	16382 MB	Extended memory
960 K - 1024 K	F0000 - FFFFF	64 KB	Runtime BIOS
896 K - 960 K	E0000 - EFFFF	64 KB	Reserved
800 K - 896 K	C8000 - DFFFF	96 KB	Potential available high DOS memory (open to the PCI Conventional bus). Dependent on video adapter used.
640 K - 800 K	A0000 - C7FFF	160 KB	Video memory and BIOS
639 K - 640 K	9FC00 - 9FFFF	1 KB	Extended BIOS data (movable by memory manager software)
512 K - 639 K	80000 - 9FBFF	127 KB	Extended conventional memory
0 K - 512 K	00000 - 7FFFF	512 KB	Conventional memory

## 2.2 Connectors and Headers



### CAUTION

*Only the following connectors and headers have overcurrent protection: back panel and front panel USB.*

*The other internal connectors and headers are not overcurrent protected and should connect only to devices inside the computer's chassis, such as fans and internal peripherals. Do not use these connectors or headers to power devices external to the computer's chassis. A fault in the load presented by the external devices could cause damage to the computer, the power cable, and the external devices themselves.*

*Furthermore, improper connection of USB header single wire connectors may eventually overload the overcurrent protection and cause damage to the board.*

This section describes the board's connectors. The connectors can be divided into these groups:

- Back panel I/O connectors
- Component-side I/O connectors and headers (see page 47)

## 2.2.1 Back Panel Connectors

Figure 10 shows the location of the back panel connectors for the board.

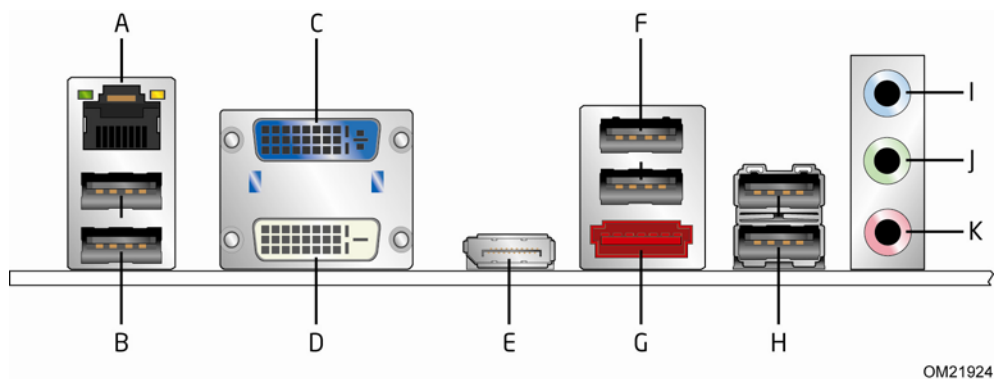

Item	Description
A	LAN
B	USB ports
C	DVI-I connector
D	DVI-D connector
E	DisplayPort connector
F	USB ports
G	eSATA port
H	USB ports
I	Audio line in
J	Audio line out
K	Mic in

**Figure 10. Back Panel Connectors**



### NOTE

*The back panel audio line out connector is designed to power headphones or amplified speakers only. Poor audio quality occurs if passive (non-amplified) speakers are connected to this output.*

### 2.2.2 Component-side Connectors and Headers

Figure 11 shows the locations of the component-side connectors and headers.

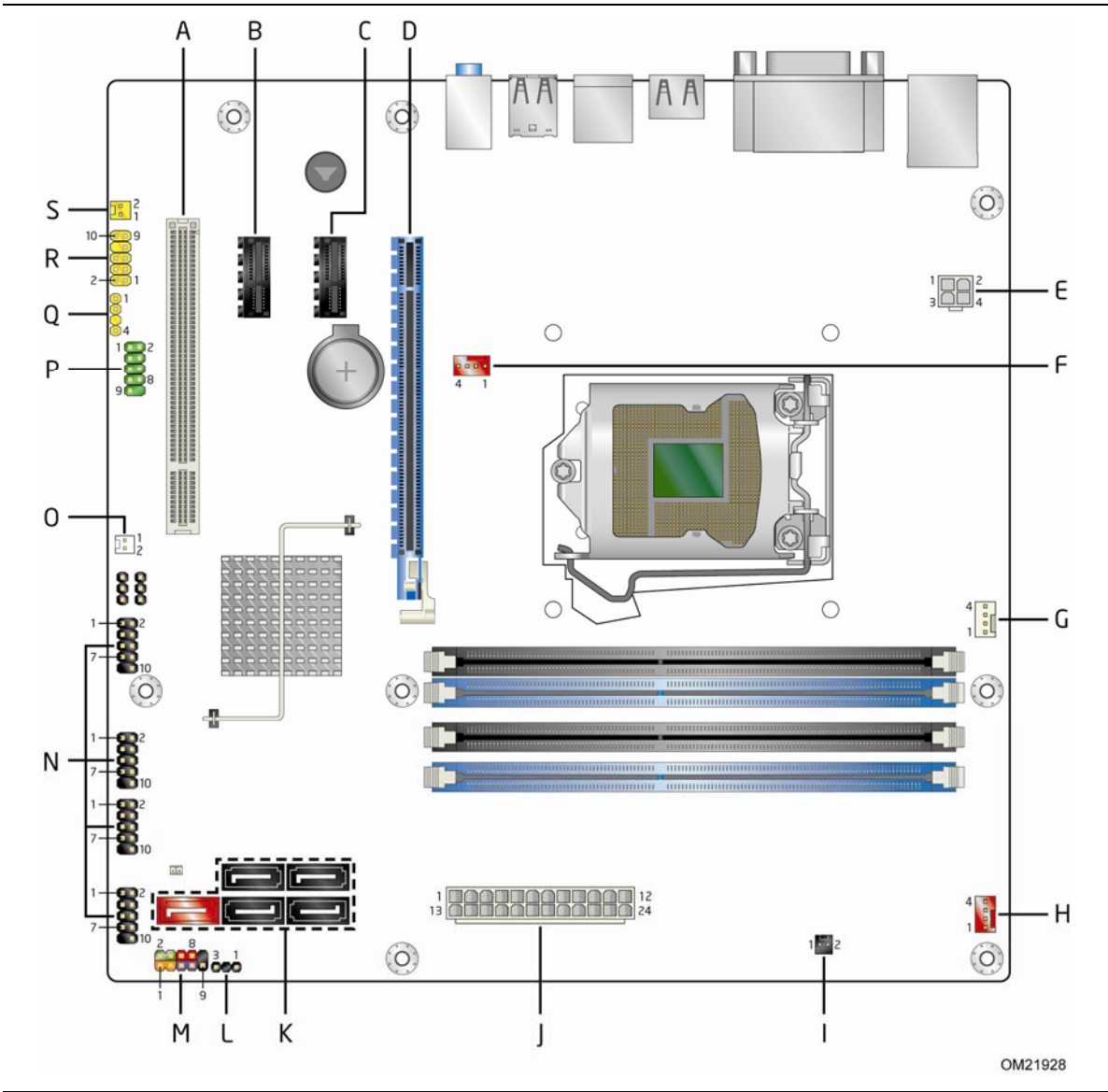

**Figure 11. Component-side Connectors and Headers**

Table 10 lists the component-side connectors and headers identified in Figure 11.

**Table 10. Component-side Connectors and Headers Shown in Figure 11**

Item/callout from Figure 11	Description
A	PCI Conventional bus add-in card connector
B	PCI Express x1 bus add-in card connector
C	PCI Express x1 bus add-in card connector
D	PCI Express x16 bus add-in card connector
E	12 V internal power connector
F	Rear chassis fan header
G	Processor fan header
H	Front chassis fan header
I	Chassis intrusion header
J	Main power connector (2 x 12)
K	SATA connectors
L	Alternate front panel LED header
M	Front panel header
N	Front panel USB headers (4)
O	Intel Remote PC Assist header
P	Serial port header
Q	S/PDIF header
R	Front panel audio header
S	Internal mono speaker header



## 2.2.2.1 Signal Tables for the Connectors and Headers

**Table 11. Serial Port Header**

Pin	Signal Name	Pin	Signal Name
1	DCD (Data Carrier Detect)	2	RXD# (Receive Data)
3	TXD# (Transmit Data)	4	DTR (Data Terminal Ready)
5	Ground	6	DSR (Data Set Ready)
7	RTS (Request To Send)	8	CTS (Clear To Send)
9	RI (Ring Indicator)	10	Key (no pin)

**Table 12. S/PDIF Header**

Pin	Signal Name
1	Ground
2	S/PDIF out
3	Key (no pin)
3	+5V_DC

**Table 13. Internal Mono Speaker Header**

Pin	Signal Name
1	–
2	+

**Table 14. Front Panel Audio Header for Intel HD Audio**

Pin	Signal Name	Pin	Signal Name
1	[Port 1] Left channel	2	Ground
3	[Port 1] Right channel	4	PRESENCE# (Dongle present)
5	[Port 2] Right channel	6	[Port 1] SENSE_RETURN
7	SENSE_SEND (Jack detection)	8	Key (no pin)
9	[Port 2] Left channel	10	[Port 2] SENSE_RETURN

**Table 15. Front Panel Audio Header for AC '97 Audio**

Pin	Signal Name	Pin	Signal Name
1	MIC	2	AUD_GND
3	MIC_BIAS	4	AUD_GND
5	FP_OUT_R	6	FP_RETURN_R
7	AUD_5V	8	KEY (no pin)
9	FP_OUT_L	10	FP_RETURN_L



**NOTE**

*Not all AC '97 signals are supported; specifically, pins 4, 6, 7, and 10 are not supported.*

**Table 16. Front Panel USB Header**

Pin	Signal Name	Pin	Signal Name
1	+5 VDC	2	+5 VDC
3	D-	4	D-
5	D+	6	D+
7	Ground	8	Ground
9	KEY (no pin)	10	No Connect

**Table 17. SATA Connectors**

Pin	Signal Name
1	Ground
2	TXP
3	TXN
4	Ground
5	RXN
6	RXP
7	Ground

**Table 18. Chassis Intrusion Header**

Pin	Signal Name
1	Intruder#
2	Ground

**Table 19. Processor (4-Pin) Fan Header**

Pin	Signal Name
1	Ground
2	+12 V
3	FAN_TACH
4	FAN_CONTROL

**Table 20. Front and Rear Chassis Fan Headers**

Pin	4-Wire Support	Pin	3-Wire Support
1	Ground	3	Ground
2	+12 V	2	FAN_POWER
3	FAN_TACH	1	FAN_TACH
4	FAN_CONTROL	N/A	N/A

**Table 21. Intel Remote PC Assist Technology Header**

Pin	Signal Name
1	RPAT#
2	Ground

### 2.2.2.2 Add-in Card Connectors

The board has the following add-in card connectors:

- One PCI Express 2.0 x16: this connector supports simultaneous transfer speeds of up to 8 GB/s of peak bandwidth per direction.
- Two PCI Express 2.0 x1: each of these connectors support simultaneous transfer speeds of up to 500 MB/s of peak bandwidth per direction.
- One Conventional PCI (rev 2.3 compliant) connector.

Note the following considerations for the Conventional PCI bus connector:

- The Conventional PCI bus connector is bus master capable.
- SMBus signals are routed to the Conventional PCI bus connector. This enables Conventional PCI bus add-in boards with SMBus support to access sensor data on the desktop board. The specific SMBus signals are as follows:
  - The SMBus clock line is connected to pin A40.
  - The SMBus data line is connected to pin A41.

### 2.2.2.3 Power Supply Connectors

The board has the following power supply connectors:

- **Main power** – a 2 x 12 connector. This connector is compatible with 2 x 10 connectors previously used on Intel Desktop boards. The board supports the use of ATX12V power supplies with either 2 x 10 or 2 x 12 main power cables. When using a power supply with a 2 x 10 main power cable, pins 11, 12, 23, and 24 must remain unconnected.
- **Processor core power** – a 2 x 2 connector. This connector provides power directly to the processor voltage regulator and must always be used. Failure to do so will prevent the board from booting.



#### CAUTION

*If a high power (75 W or greater) add-in card is installed in the PCI Express x16 connector, that card must also be connected directly to the power supply. Failure to do so may cause damage to the board and the add-in card.*

**Table 22. Processor Core Power Connector**

Pin	Signal Name	Pin	Signal Name
1	Ground	2	Ground
3	+12 V	4	+12 V

**Table 23. Main Power Connector**

Pin	Signal Name	Pin	Signal Name
1	+3.3 V	13	+3.3 V
2	+3.3 V	14	-12 V
3	Ground	15	Ground
4	+5 V	16	PS-ON# (power supply remote on/off)
5	Ground	17	Ground
6	+5 V	18	Ground
7	Ground	19	Ground
8	PWRGD (Power Good)	20	-5 V (obsolete)
9	+5 V (Standby)	21	+5 V
10	+12 V	22	+5 V
11	+12 V (Note)	23	+5 V (Note)
12	+3.3 V 2 x 12 connector detect (Note)	24	Ground (Note)

Note: When using a 2 x 10 power supply cable, this pin will be unconnected.

#### For information about

Power supply considerations

#### Refer to

Section 2.6.1 on page 60

### 2.2.2.4 Front Panel Header

This section describes the functions of the front panel header. Table 24 lists the signal names of the front panel header. Figure 12 is a connection diagram for the front panel header.

**Table 24. Front Panel Header**

Pin	Signal	In/Out	Description	Pin	Signal	In/Out	Description
Hard Drive Activity LED				Power LED			
1	HD_PWR	Out	Hard disk LED pull-up to +5 V	2	FP_LED+	Out	Front panel green LED
3	HDA#	Out	Hard disk active LED	4	FP_LED-	Out	Front panel yellow LED
Reset Switch				On/Off Switch			
5	Ground		Ground	6	PWR#	In	Power switch
7	FP_RESET#	In	Reset switch	8	Ground		Ground
Power				Not Connected			
9	+5 V		Power	10	N/C		Not connected

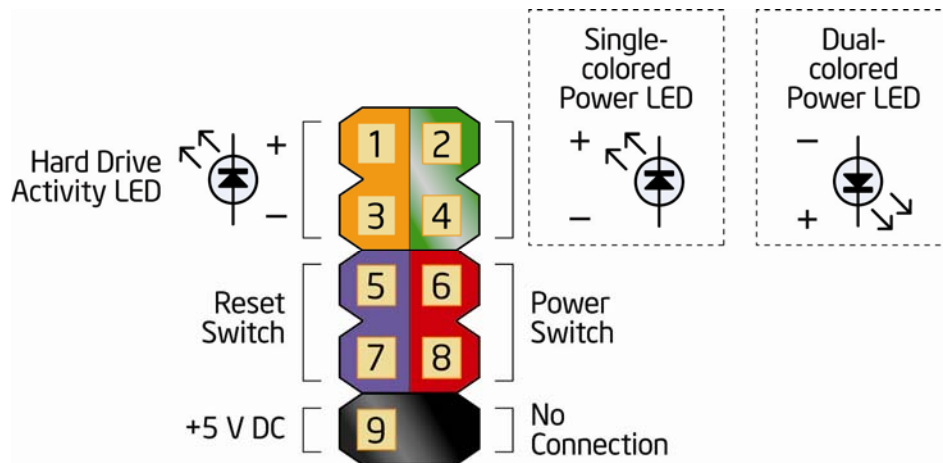

OM20472

**Figure 12. Connection Diagram for Front Panel Header**

#### 2.2.2.4.1 Hard Drive Activity LED Header

Pins 1 and 3 can be connected to an LED to provide a visual indicator that data is being read from or written to an internal storage device. Proper LED function requires a SATA hard drive or optical drive connected to an onboard SATA connector.

#### 2.2.2.4.2 Reset Switch Header

Pins 5 and 7 can be connected to a momentary single pole, single throw (SPST) type switch that is normally open. When the switch is closed, the board resets and runs the POST.

#### 2.2.2.4.3 Power LED Header

Pins 2 and 4 can be connected to a one- or two-color LED. Table 25 shows the default states for this LED. More options are available through BIOS setup.

**Table 25. States for a One-Color Power LED**

LED State	Description
Off	Power off/sleeping
Steady Lit	Running
Blink	Standby

#### 2.2.2.4.4 Power Switch Header

Pins 6 and 8 can be connected to a front panel momentary-contact power switch. The switch must pull the SW\_ON# pin to ground for at least 50 ms to signal the power supply to switch on or off. (The time requirement is due to internal debounce circuitry on the board.) At least two seconds must pass before the power supply will recognize another on/off signal.

#### 2.2.2.5 Alternate Front Panel Power LED Header

Pins 1 and 3 of this header duplicate the signals on pins 2 and 4 of the front panel header.

**Table 26. Alternate Front Panel Power LED Header**

Pin	Signal Name	In/Out	Description
1	FP_LED+	Out	FP_LED+
2	Not connected		
3	FP_LED-	Out	FP_LED-

### 2.2.2.6 Front Panel USB Headers

Figure 13 is a connection diagram for the front panel USB headers.



**NOTE**

- The +5 V DC power on the USB headers is fused.
- Use only a front panel USB connector that conforms to the USB 2.0 specification for high-speed USB devices.

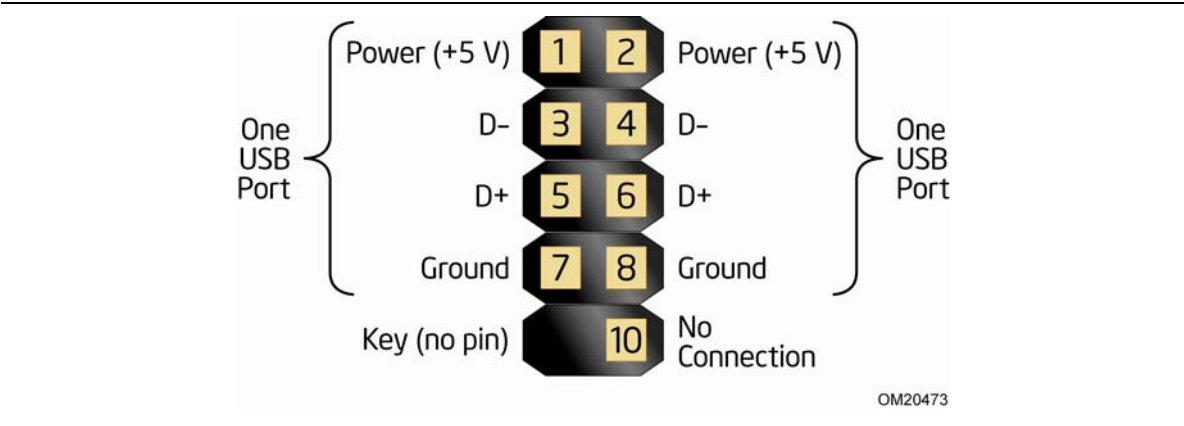

**Figure 13. Connection Diagram for Front Panel USB Headers**

## 2.3 BIOS Configuration Jumper Block



### CAUTION

*Do not move the jumper with the power on. Always turn off the power and unplug the power cord from the computer before changing a jumper setting. Otherwise, the board could be damaged.*

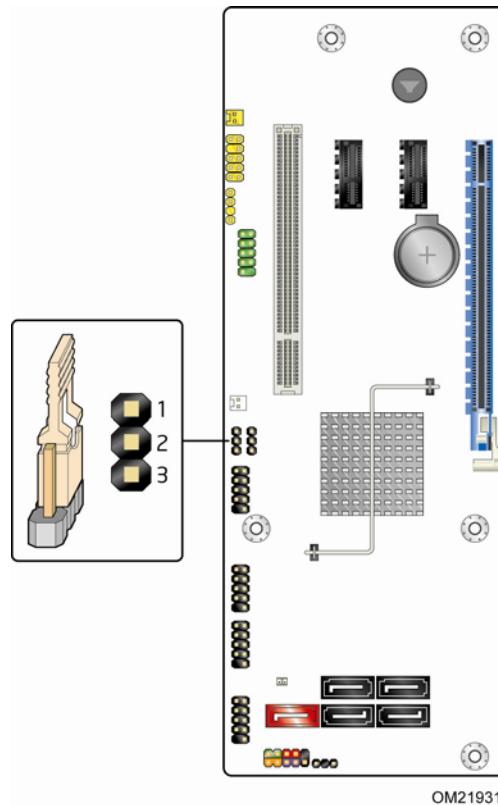

Figure 14 shows the location of the jumper block. The 3-pin jumper block determines the BIOS Setup program's mode. Table 27 describes the jumper settings for the three modes: normal, configure, and recovery.



**Figure 14. Location of the Jumper Block**

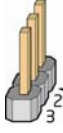

**Table 27. BIOS Setup Configuration Jumper Settings**

Function/Mode	Jumper Setting	Configuration	Configuration
Normal	1-2		<p>The BIOS uses current configuration information and passwords for booting.</p>
Configure	2-3		<p>After the POST runs, Setup runs automatically. The maintenance menu is displayed.</p> <p>Note that this Configure mode is the only way to clear the BIOS/CMOS settings. Press F9 (restore defaults) while in Configure mode to restore the BIOS/CMOS settings to their default values.</p>
Recovery	None		<p>The BIOS attempts to recover the BIOS configuration. A recovery CD or USB flash drive is required.</p>

## 2.4 Clear CMOS Header

Figure 15 shows the location of the Clear CMOS header. In order to initiate a CMOS clear, a jumper (not included) must be connected to the jumper block pins for at least two seconds (see Table 28).



### CAUTION

*Initiating a CMOS clear when the board is powered on (S0 mode) or in standby (S1 or S3 mode) may damage the board.*

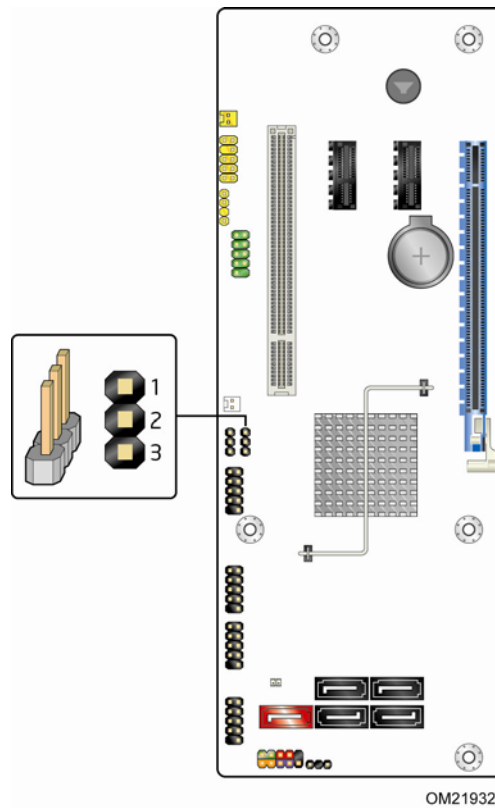

Figure 15. CMOS Clear Header

Table 28. Clear CMOS

Pin	Function
1-2	Clear CMOS
2-3	N/A
No Jumper	Normal

## 2.5 Mechanical Considerations

### 2.5.1 Form Factor

The board is designed to fit into a microATX form-factor chassis. Figure 16 illustrates the mechanical form factor for the board. Dimensions are given in inches [millimeters]. The outer dimensions are 9.60 inches by 9.60 inches [243.84 millimeters by 243.84 millimeters]. Location of the I/O connectors and mounting holes are in compliance with the ATX specification.

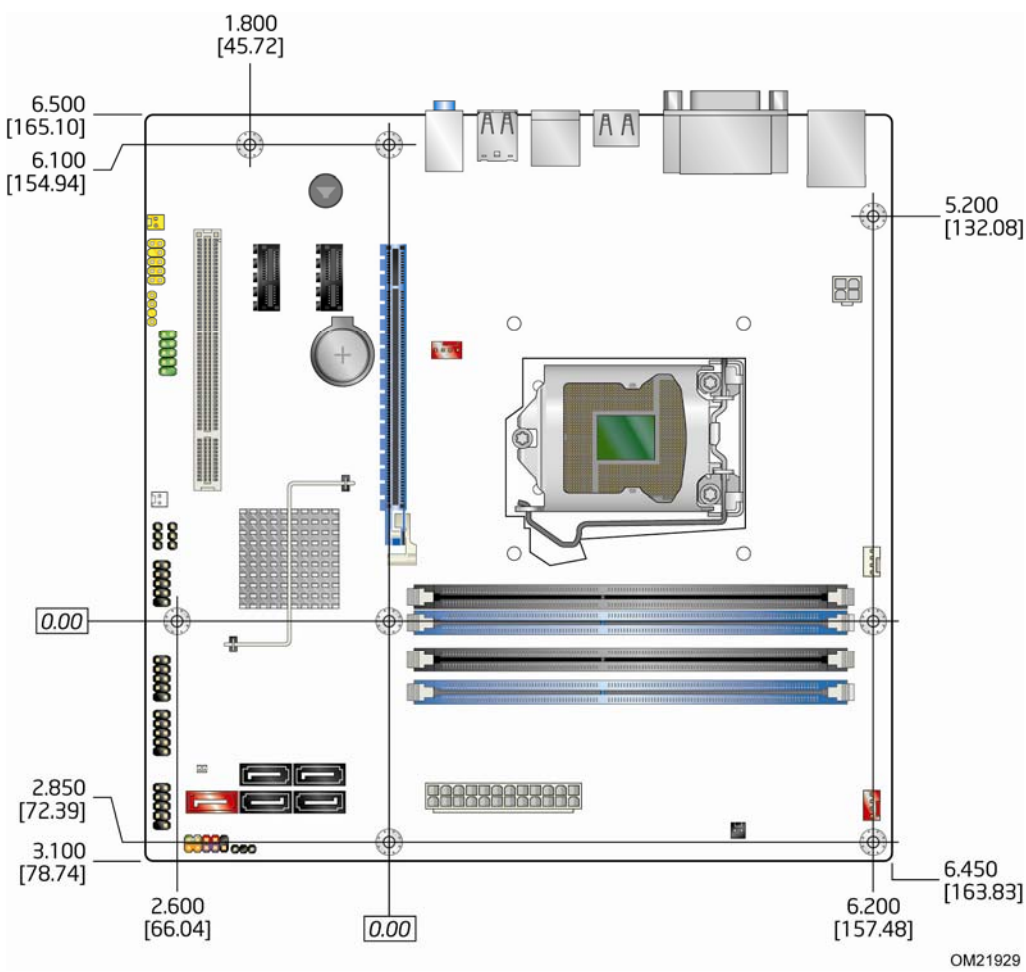

Figure 16. Board Dimensions

## 2.6 Electrical Considerations

### 2.6.1 Power Supply Considerations



#### CAUTION

The +5 V standby line from the power supply must be capable of providing adequate +5 V standby current. Failure to do so can damage the power supply. The total amount of standby current required depends on the wake devices supported and manufacturing options.

Additional power required will depend on configurations chosen by the integrator.

The power supply must comply with the indicated parameters of the ATX form factor specification.

- The potential relation between 3.3 VDC and +5 VDC power rails
- The current capability of the +5 VSB line
- All timing parameters
- All voltage tolerances

For example, for a system consisting of a supported 95 W processor (see Section 1.4 on page 14 for information on supported processors), 2 GB DDR3 RAM, one high end video card, one hard disk drive, one optical drive, and all board peripherals enabled, the minimum recommended power supply is 460 W. Table 29 lists the recommended power supply current values.

**Table 29. Recommended Power Supply Current Values**

<b>Output Voltage</b>	3.3 V	5 V	12 V1	12 V2	-12 V	5 VSB
<b>Current</b>	22 A	20 A	16 A	16 A	0.3 A	1.5 A

#### For information about

Selecting an appropriate power supply

#### Refer to

<http://www.intel.com/support/motherboards/desktop/sb/CS-026472.htm>

## 2.6.2 Fan Header Current Capability



### CAUTION

*The processor fan must be connected to the processor fan header, not to a chassis fan header. Connecting the processor fan to a chassis fan header may result in onboard component damage that will halt fan operation.*

Table 30 lists the current capability of the fan headers.

**Table 30. Fan Header Current Capability**

Fan Header	Maximum Available Current
Processor fan	2.0 A
Front chassis fan	1.5 A
Rear chassis fan	1.5 A

## 2.6.3 Add-in Board Considerations

The board is designed to provide 2 A (average) of current for each add-in board from the +5 V rail. The total +5 V current draw for add-in boards for a fully loaded board (all expansion slots filled) must not exceed the system's power supply +5 V maximum current.

## 2.7 Thermal Considerations



### **CAUTION**

*A chassis with a maximum internal ambient temperature of 38 °C at the processor fan inlet is required. Use of a processor heat sink that provides omni-directional airflow to maintain required airflow across the processor voltage regulator area is highly recommended. For a list of chassis that have been tested with Intel desktop boards please refer to the following website:*

*[http://www3.intel.com/cd/channel/reseller/asmo-na/eng/tech\\_reference/53211.htm](http://www3.intel.com/cd/channel/reseller/asmo-na/eng/tech_reference/53211.htm)*

*All responsibility for determining the adequacy of any thermal or system design remains solely with the reader. Intel makes no warranties or representations that merely following the instructions presented in this document will result in a system with adequate thermal performance.*



### **CAUTION**

*The ambient temperature must not exceed the board's maximum operating temperature. Failure to do so could cause components to exceed their maximum case temperature and malfunction. For information about the maximum operating temperature, see the environmental specifications in Section 2.9.*



### **CAUTION**

*Ensure that proper airflow is maintained in the processor voltage regulator circuit. Failure to do so may result in damage to the voltage regulator circuit.*

Figure 17 shows the locations of the localized high temperature zones.

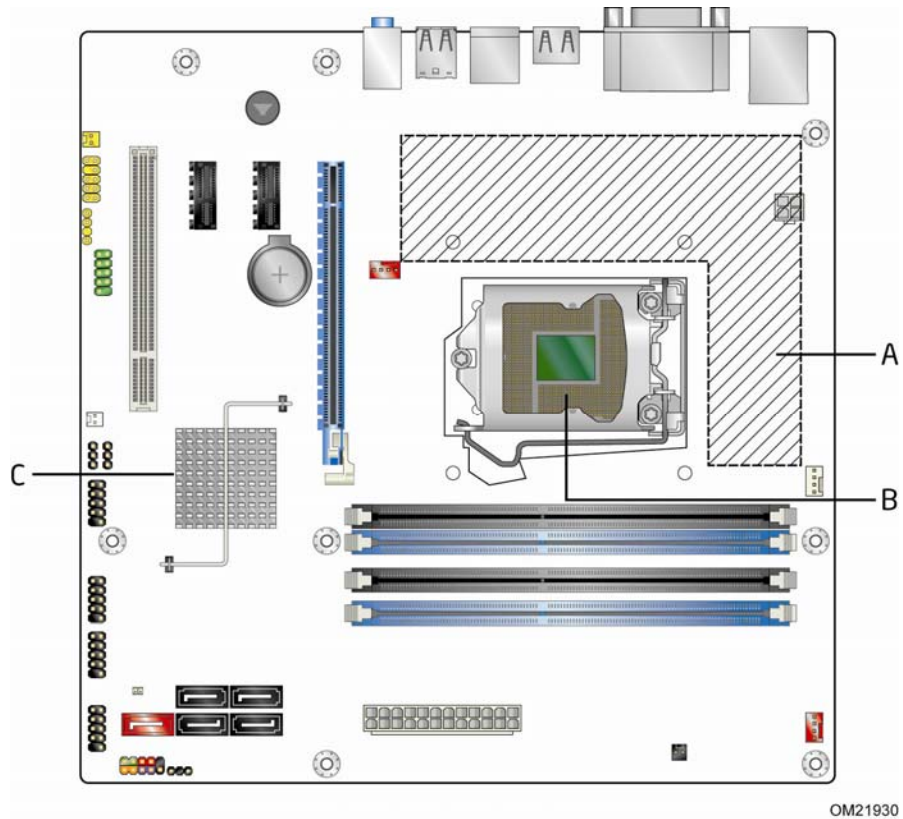

Item	Description
A	Processor voltage regulator area
B	Processor
C	Intel Q57 Express Chipset

**Figure 17. Localized High Temperature Zones**

Table 31 provides maximum case temperatures for the components that are sensitive to thermal changes. The operating temperature, current load, or operating frequency could affect case temperatures. Maximum case temperatures are important when considering proper airflow to cool the board.

**Table 31. Thermal Considerations for Components**

Component	Maximum Case Temperature
Processor	For processor case temperature, see processor datasheets and processor specification updates
Intel Q57 Express Chipset	111 °C (under bias)

For information about	Refer to
Processor datasheets and specification updates	Section 1.3, page 14

## 2.8 Reliability

The Mean Time Between Failures (MTBF) prediction is calculated using component and subassembly random failure rates. The calculation is based on the Telcordia "Reliability Prediction Procedure for Electronic Equipment" SR-332 Issue 1, an update of Bellcore TR-332, Issue 6. The MTBF prediction is used to estimate repair rates and spare parts requirements.

The MTBF data is calculated from predicted data at 55 °C. The MTBF for the board is 107,515 hours.

## 2.9 Environmental

Table 32 lists the environmental specifications for the board.

**Table 32. Environmental Specifications**

Parameter	Specification		
<b>Temperature</b>			
Non-Operating	-40 °C to +60 °C		
Operating	0 °C to +40 °C		
<b>Shock</b>			
Unpackaged	50 g trapezoidal waveform		
	Velocity change of 170 inches/second <sup>2</sup>		
Packaged	Half sine 2 millisecond		
	Product Weight (pounds)	Free Fall (inches)	Velocity Change (inches/sec <sup>2</sup> )
	<20	36	167
	21-40	30	152
	41-80	24	136
	81-100	18	118
<b>Vibration</b>			
Unpackaged	5 Hz to 20 Hz: 0.01 g <sup>2</sup> Hz sloping up to 0.02 g <sup>2</sup> Hz		
	20 Hz to 500 Hz: 0.02 g <sup>2</sup> Hz (flat)		
Packaged	5 Hz to 40 Hz: 0.015 g <sup>2</sup> Hz (flat)		
	40 Hz to 500 Hz: 0.015 g <sup>2</sup> Hz sloping down to 0.00015 g <sup>2</sup> Hz		



# 3 Overview of BIOS Features

---

## 3.1 Introduction

The board uses an Intel BIOS that is stored in a 64 Mbit (8,192 KB) Serial Peripheral Interface Flash Memory (SPI Flash) device which can be updated using a set of utilities. The SPI Flash contains the BIOS Setup program, POST, LAN EEPROM information, Plug and Play support, and other firmware.

The BIOS displays a message during POST identifying the type of BIOS and a revision code. The initial production BIOSs are identified as TMIBX10H.86A.

The BIOS Setup program can be used to view and change the BIOS settings for the computer. The BIOS Setup program is accessed by pressing the <F2> key after the Power-On Self-Test (POST) memory test begins and before the operating system boot begins. The menu bar is shown below.

Maintenance	Main Configuration	Performance	Security	Power	Boot	Intel ME	Exit
-------------	--------------------	-------------	----------	-------	------	----------	------



### **NOTE**

*The maintenance menu is displayed only when the board is in configure mode. Section 2.3 on page 56 shows how to put the board in configure mode.*

Table 33 lists the BIOS Setup program menu features.

**Table 33. BIOS Setup Program Menu Bar**

Maintenance	Main	Configura- tion	Performance	Security	Power	Boot	Intel ME	Exit
Clears passwords and displays processor information	Displays processor and memory configuration	Configures advanced features available through the chipset	Configures Memory and Processor overrides	Sets passwords and security features	Configures power management features	Selects boot options	Configure Intel ME and Intel AMT settings	Saves or discards changes to Setup program options

Table 34 lists the function keys available for menu screens.

**Table 34. BIOS Setup Program Function Keys**

BIOS Setup Program Function Key	Description
<<-> or <->>	Selects a different menu screen (Moves the cursor left or right)
<↑> or <↓>	Selects an item (Moves the cursor up or down)
<Tab>	Selects sub-items within a field (i.e., date/time)
<Enter>	Executes command or selects the submenu
<F9>	Load the default configuration values for the current menu
<F10>	Save the current values and exits the BIOS Setup program
<Esc>	Exits the menu

## 3.2 System Management BIOS (SMBIOS)

SMBIOS is a Desktop Management Interface (DMI) compliant method for managing computers in a managed network.

The main component of SMBIOS is the Management Information Format (MIF) database, which contains information about the computing system and its components. Using SMBIOS, a system administrator can obtain the system types, capabilities, operational status, and installation dates for system components. The MIF database defines the data and provides the method for accessing this information. The BIOS enables applications such as third-party management software to use SMBIOS. The BIOS stores and reports the following SMBIOS information:

- BIOS data, such as the BIOS revision level
- Fixed-system data, such as peripherals, serial numbers, and asset tags
- Resource data, such as memory size, cache size, and processor speed
- Dynamic data, such as event detection and error logging

Non-Plug and Play operating systems require an additional interface for obtaining the SMBIOS information. The BIOS supports an SMBIOS table interface for such operating systems. Using this support, an SMBIOS service-level application running on a non-Plug and Play operating system can obtain the SMBIOS information. Additional board information can be found in the BIOS under the Additional Information header under the Main BIOS page.

## 3.3 Legacy USB Support

Legacy USB support enables USB devices to be used even when the operating system's USB drivers are not yet available. Legacy USB support is used to access the BIOS Setup program, and to install an operating system that supports USB. By default, Legacy USB support is set to Enabled.

Legacy USB support operates as follows:

1. When you apply power to the computer, legacy support is disabled.
2. POST begins.
3. Legacy USB support is enabled by the BIOS allowing you to use a USB keyboard to enter and configure the BIOS Setup program and the maintenance menu.
4. POST completes.
5. The operating system loads. While the operating system is loading, USB keyboards and mice are recognized and may be used to configure the operating system. (Keyboards and mice are not recognized during this period if Legacy USB support was set to Disabled in the BIOS Setup program.)
6. After the operating system loads the USB drivers, all legacy and non-legacy USB devices are recognized by the operating system, and Legacy USB support from the BIOS is no longer used.

## 3.4 BIOS Updates

The BIOS can be updated using either of the following utilities, which are available on the Intel World Wide Web site:

- Intel® Express BIOS Update utility, which enables automated updating while in the Windows environment. Using this utility, the BIOS can be updated from a file on a hard disk, a USB drive (a flash drive or a USB drive), or an optical drive.
- Intel® Flash Memory Update Utility, which requires booting from DOS. Using this utility, the BIOS can be updated from a file on a hard disk, a USB drive (a flash drive or a USB drive), or an optical drive.
- Intel® F7 switch allows a user to select where the BIOS .bio file is located and perform the update from that location/device. Similar to performing a BIOS Recovery without removing the BIOS configuration jumper.

Both utilities verify that the updated BIOS matches the target system to prevent accidentally installing an incompatible BIOS.



### NOTE

*Review the instructions distributed with the upgrade utility before attempting a BIOS update.*

<b>For information about</b>	<b>Refer to</b>
------------------------------	-----------------

BIOS update utilities	<a href="http://www.intel.com/support/motherboards/desktop/sb/CS-022312.htm">http://www.intel.com/support/motherboards/desktop/sb/CS-022312.htm</a>
-----------------------	---

### 3.4.1 Language Support

The BIOS Setup program and help messages are supported in US English.

### 3.4.2 Custom Splash Screen

During POST, an Intel® splash screen is displayed by default. This splash screen can be augmented with a custom splash screen. The Intel Integrator’s Toolkit that is available from Intel can be used to create a custom splash screen.

For information about	Refer to
Intel® Integrator Toolkit	<a href="http://developer.intel.com/design/motherbd/software/itk/">http://developer.intel.com/design/motherbd/software/itk/</a>
Additional Intel® software tools	<a href="http://developer.intel.com/products/motherboard/DQ57TM/tools.htm">http://developer.intel.com/products/motherboard/DQ57TM/tools.htm</a>
	and
	<a href="http://developer.intel.com/design/motherbd/software.htm">http://developer.intel.com/design/motherbd/software.htm</a>

## 3.5 BIOS Recovery

It is unlikely that anything will interrupt a BIOS update; however, if an interruption occurs, the BIOS could be damaged. Table 35 lists the drives and media types that can and cannot be used for BIOS recovery. The BIOS recovery media does not need to be made bootable however, it must contain the motherboard .bio file at the root level.

**Table 35. Acceptable Drives/Media Types for BIOS Recovery**

Media Type	Can be used for BIOS recovery?
Optical drive connected to the SATA interface	Yes
USB removable drive (a USB Flash Drive, for example)	Yes
USB diskette drive (with a 1.44 MB diskette)	No
USB hard disk drive	No
Legacy diskette drive (with a 1.44 MB diskette) connected to the legacy diskette drive interface	No

For information about	Refer to
BIOS recovery	<a href="http://www.intel.com/support/motherboards/desktop/sb/cs-023360.htm">http://www.intel.com/support/motherboards/desktop/sb/cs-023360.htm</a>

## 3.6 Boot Options

In the BIOS Setup program, the user can choose to boot from a hard drive, optical drive, removable drive, or the network. The default setting is for the optical drive to be the first boot device, the hard drive second, removable drive third, and the network fourth.

### 3.6.1 Optical Drive Boot

Booting from the optical drive is supported in compliance to the El Torito bootable CD-ROM format specification. Under the Boot menu in the BIOS Setup program, the optical drive is listed as a boot device. Boot devices are defined in priority order. Accordingly, if there is not a bootable CD in the optical drive, the system will attempt to boot from the next defined drive.

### 3.6.2 Network Boot

The network can be selected as a boot device. This selection allows booting from the onboard LAN or a network add-in card with a remote boot ROM installed.

Pressing the <F12> key during POST automatically forces booting from the LAN. To use this key during POST, the User Access Level in the BIOS Setup program's Security menu must be set to Full.

### 3.6.3 Booting Without Attached Devices

For use in embedded applications, the BIOS has been designed so that after passing the POST, the operating system loader is invoked even if the following devices are not present:

- Video adapter
- Keyboard
- Mouse

### 3.6.4 Changing the Default Boot Device During POST

Pressing the <F10> key during POST causes a boot device menu to be displayed. This menu displays the list of available boot devices. Table 36 lists the boot device menu options.

**Table 36. Boot Device Menu Options**

Boot Device Menu Function Keys	Description
<↑> or <↓>	Selects a default boot device
<Enter>	Exits the menu, and boots from the selected device
<Esc>	Exits the menu and boots according to the boot priority defined through BIOS setup

## 3.7 Hard Disk Drive Password Security Feature

The Hard Disk Drive Password Security feature blocks read and write accesses to the hard disk drive until the correct password is given. Hard Disk Drive Passwords are set in BIOS SETUP and are prompted for during BIOS POST. For convenient support of S3 resume, the system BIOS will automatically unlock drives on resume from S3.

The User hard disk drive password, when installed, will be required upon each power-cycle until the Master Key or User hard disk drive password is submitted.

The Master Key hard disk drive password, when installed, will not lock the drive. The Master Key hard disk drive password exists as an unlock override in the event that the User hard disk drive password is forgotten. Only the installation of the User hard disk drive password will cause a hard disk to be locked upon a system power-cycle.

Table 37 shows the effects of setting the Hard Disk Drive Passwords.

**Table 37. Master Key and User Hard Drive Password Functions**

Password Set	Password During Boot
Neither	None
Master only	None
User only	User only
Master and User Set	Master or User

During every POST, if a User hard disk drive password is set, POST execution will pause with the following prompt to force the user to enter the Master Key or User hard disk drive password:

```
Enter Hard Disk Drive Password:
```

Upon successful entry of the Master Key or User hard disk drive password, the system will continue with normal POST.

If the hard disk drive password is not correctly entered, the system will go back to the above prompt. The user will have three attempts to correctly enter the hard disk drive password. After the third unsuccessful hard disk drive password attempt, the system will halt with the message:

```
Hard Disk Drive Password Entry Error
```

A manual power cycle will be required to resume system operation.



### NOTE

*As implemented on DQ57TM, Hard Disk Drive Password Security is only supported on SATA port 0. The passwords are stored on the hard disk drive so if the drive is relocated to another SATA port or computer that does not support Hard Disk Drive Password Security feature, the drive will not be accessible.*



## NOTE

*Hard Disk Drive Password Security is not supported in PCH RAID mode. Secured hard disk drives attached to the system when the system is in PCH RAID mode will not be accessible due to the disabling of BIOS Hard Disk Drive Password support.*

## 3.8 BIOS Security Features

The BIOS includes security features that restrict access to the BIOS Setup program and who can boot the computer. A supervisor password and a user password can be set for the BIOS Setup program and for booting the computer, with the following restrictions:

- The supervisor password gives unrestricted access to view and change all the Setup options in the BIOS Setup program. This is the supervisor mode.
- The user password gives restricted access to view and change Setup options in the BIOS Setup program. This is the user mode.
- If only the supervisor password is set, pressing the <Enter> key at the password prompt of the BIOS Setup program allows the user restricted access to Setup.
- If both the supervisor and user passwords are set, users can enter either the supervisor password or the user password to access Setup. Users have access to Setup respective to which password is entered.
- Setting the user password restricts who can boot the computer. The password prompt will be displayed before the computer is booted. If only the supervisor password is set, the computer boots without asking for a password. If both passwords are set, the user can enter either password to boot the computer.
- For enhanced security, use different passwords for the supervisor and user passwords.
- Valid password characters are A-Z, a-z, and 0-9. Passwords may be up to 16 characters in length.



Table 38 shows the effects of setting the supervisor password and user password. This table is for reference only and is not displayed on the screen.

**Table 38. Supervisor and User Password Functions**

<b>Password Set</b>	<b>Supervisor Mode</b>	<b>User Mode</b>	<b>Setup Options</b>	<b>Password to Enter Setup</b>	<b>Password During Boot</b>
Neither	Can change all options (Note)	Can change all options (Note)	None	None	None
Supervisor only	Can change all options	Can change a limited number of options	Supervisor Password	Supervisor	None
User only	N/A	Can change all options	Enter Password Clear User Password	User	User
Supervisor and user set	Can change all options	Can change a limited number of options	Supervisor Password Enter Password	Supervisor or user	Supervisor or user

Note: If no password is set, any user can change all Setup options.



# 4 Error Messages and Beep Codes

---

## 4.1 Speaker

The board-mounted piezoelectric speaker provides audible error code (beep code) information during POST.

**For information about**

The location of the onboard speaker

**Refer to**

Figure 1, page 11

---

## 4.2 BIOS Beep Codes

Whenever a recoverable error occurs during POST, the BIOS causes the board's piezoelectric speaker to beep an error message describing the problem (see Table 39).

**Table 39. BIOS Beep Codes**

Type	Pattern	Frequency/Comments
F2 Setup/F10 Boot Menu Prompt	One 0.5 second beep when BIOS is ready to accept keyboard input	932 Hz
BIOS update in progress	None	
Video error (no add-in graphics card installed)	On-off (1.0 second each) two times, then 2.5-second pause (off), entire pattern repeats (beeps and pause) once and the BIOS will continue to boot.	932 Hz For processors requiring an add-in graphics card
Memory error	On-off (1.0 second each) three times, then 2.5-second pause (off), entire pattern repeats (beeps and pause) until the system is powered off.	932 Hz
Thermal trip warning	Alternate high and low beeps (1.0 second each) for eight beeps, followed by system shut down.	High beep 2000 Hz Low beep 1500 Hz

## 4.3 Front-panel Power LED Blink Codes

Whenever a recoverable error occurs during POST, the BIOS causes the board's front panel power LED to blink an error message describing the problem (see Table 40).

**Table 40. Front-panel Power LED Blink Codes**

Type	Pattern	Note
F2 Setup/F10 Boot Menu Prompt	None	
BIOS update in progress	Off when the update begins, then on for 0.5 seconds, then off for 0.5 seconds. The pattern repeats until the BIOS update is complete.	
Video error (no add-in graphics card installed)	On-off (1.0 second each) two times, then 2.5-second pause (off), entire pattern repeats (blink and pause) until the system is powered off.	For processors requiring an add-in graphics card
Memory error	On-off (1.0 second each) three times, then 2.5-second pause (off), entire pattern repeats (blinks and pause) until the system is powered off.	
Thermal trip warning	Each beep will be accompanied by the following blink pattern: .25 seconds On, .25 seconds Off, .25 seconds On, .25 seconds Off. This will result in a total of 16 blinks.	

## 4.4 BIOS Error Messages

Table 41 lists the error messages and provides a brief description of each.

**Table 41. BIOS Error Messages**

Error Message	Explanation
CMOS Battery Low	The battery may be losing power. Replace the battery soon.
CMOS Checksum Bad	The CMOS checksum is incorrect. CMOS memory may have been corrupted. Run Setup to reset values.
Memory Size Decreased	Memory size has decreased since the last boot. If no memory was removed, then memory may be bad.
No Boot Device Available	System did not find a device to boot.

## 4.5 Port 80h POST Codes

During the POST, the BIOS generates diagnostic progress codes (POST codes) to I/O port 80h. If the POST fails, execution stops and the last POST code generated is left at port 80h. This code is useful for determining the point where an error occurred.

Displaying the POST codes requires a PCI bus add-in card, often called a POST card. The POST card can decode the port and display the contents on a medium such as a seven-segment display.



### NOTE

*The POST card must be installed in the PCI bus connector.*

The following tables provide information about the POST codes generated by the BIOS:

- Table 42 lists the Port 80h POST code ranges
- Table 43 lists the Port 80h POST codes themselves
- Table 44 lists the Port 80h POST sequence



### NOTE

*In the tables listed above, all POST codes and range values are listed in hexadecimal.*

**Table 42. Port 80h POST Code Ranges**

Range	Category/Subsystem
00 – 0F	Debug codes: Can be used by any PEIM/driver for debug.
10 – 1F	Host Processors: 1F is an unrecoverable CPU error.
20 – 2F	Memory/Chipset: 2F is no memory detected or no useful memory detected.
30 – 3F	Recovery: 3F indicated recovery failure.
40 – 4F	Reserved for future use.
50 – 5F	I/O Busses: PCI, USB, ATA, etc. 5F is an unrecoverable error. Start with PCI.
60 – 6F	Reserved for future use (for new busses).
70 – 7F	Output Devices: All output consoles. 7F is an unrecoverable error.
80 – 8F	Reserved for future use (new output console codes).
90 – 9F	Input devices: Keyboard/Mouse. 9F is an unrecoverable error.
A0 – AF	Reserved for future use (new input console codes).
B0 – BF	Boot Devices: Includes fixed media and removable media. BF is an unrecoverable error.
C0 – CF	Reserved for future use.
D0 – DF	Boot device selection.
E0 – FF	E0 – EE: Miscellaneous codes. See Table 43. EF: boot/S3 resume failure. F0 – FF: FF processor exception.

**Table 43. Port 80h POST Codes**

<b>POST Code</b>	<b>Description of POST Operation</b>
<b>Host Processor</b>	
10	Power-on initialization of the host processor (Boot Strap Processor)
11	Host processor cache initialization (including APs)
12	Starting Application processor initialization
13	SMM initialization
<b>Chipset</b>	
21	Initializing a chipset component
<b>Memory</b>	
22	Reading SPD from memory DIMMs
23	Detecting presence of memory DIMMs
24	Programming timing parameters in the memory controller and the DIMMs
25	Configuring memory
26	Optimizing memory settings
27	Initializing memory, such as ECC init
29	Memory testing completed
<b>PCI Bus</b>	
50	Enumerating PCI busses
51	Allocating resources to PCI bus
52	Hot Plug PCI controller initialization
53 – 57	Reserved for PCI Bus
<b>USB</b>	
58	Resetting USB bus
59	Reserved for USB
<b>ATA/ATAPI/SATA</b>	
5A	Resetting PATA/SATA bus and all devices
5B	Reserved for ATA
<b>SMBus</b>	
5C	Resetting SMBus
5D	Reserved for SMBus
<b>Local Console</b>	
70	Resetting the VGA controller
71	Disabling the VGA controller
72	Enabling the VGA controller
<b>Remote Console</b>	
78	Resetting the console controller
79	Disabling the console controller
7A	Enabling the console controller

continued

**Table 43. Port 80h POST Codes** (continued)

<b>POST Code</b>	<b>Description of POST Operation</b>
<b>Keyboard (USB)</b>	
90	Resetting keyboard
91	Disabling keyboard
92	Detecting presence of keyboard
93	Enabling the keyboard
94	Clearing keyboard input buffer
95	Instructing keyboard controller to run Self Test (PS/2 only)
<b>Mouse (USB)</b>	
98	Resetting mouse
99	Disabling mouse
9A	Detecting presence of mouse
9B	Enabling mouse
<b>Fixed Media</b>	
B0	Resetting fixed media
B1	Disabling fixed media
B2	Detecting presence of a fixed media (hard drive detection etc.)
B3	Enabling/configuring a fixed media
<b>Removable Media</b>	
B8	Resetting removable media
B9	Disabling removable media
BA	Detecting presence of a removable media (CD-ROM detection, etc.)
BC	Enabling/configuring a removable media
<b>BDS</b>	
Dy	Trying boot selection y (y=0 to 15)
<b>PEI Core</b>	
E0	Started dispatching PEIMs (emitted on first report of EFI_SW_PC_INIT_BEGIN EFI_SW_PEI_PC_HANDOFF_TO_NEXT)
E2	Permanent memory found
E1, E3	Reserved for PEI/PEIMs
<b>DXE Core</b>	
E4	Entered DXE phase
E5	Started dispatching drivers
E6	Started connecting drivers

continued

**Table 43. Port 80h POST Codes** (continued)

<b>POST Code</b>	<b>Description of POST Operation</b>
<b>DXE Drivers</b>	
E7	Waiting for user input
E8	Checking password
E9	Entering BIOS setup
EB	Calling Legacy Option ROMs
<b>Runtime Phase/EFI OS Boot</b>	
F4	Entering Sleep state
F5	Exiting Sleep state
F8	EFI boot service ExitBootServices ( ) has been called
F9	EFI runtime service SetVirtualAddressMap ( ) has been called
FA	EFI runtime service ResetSystem ( ) has been called
<b>PEIMs/Recovery</b>	
30	Crisis Recovery has initiated per user request
31	Crisis Recovery has initiated by software (corrupt flash)
34	Loading recovery capsule
35	Handing off control to the recovery capsule
3F	Unable to recover



**Table 44. Typical Port 80h POST Sequence**

<b>POST Code</b>	<b>Description</b>
21	Initializing a chipset component
22	Reading SPD from memory DIMMs
23	Detecting presence of memory DIMMs
25	Configuring memory
28	Testing memory
34	Loading recovery capsule
E4	Entered DXE phase
12	Starting application processor initialization
13	SMM initialization
50	Enumerating PCI busses
51	Allocating resourced to PCI bus
92	Detecting the presence of the keyboard
90	Resetting keyboard
94	Clearing keyboard input buffer
95	Keyboard Self Test
EB	Calling Video BIOS
58	Resetting USB bus
5A	Resetting PATA/SATA bus and all devices
92	Detecting the presence of the keyboard
90	Resetting keyboard
94	Clearing keyboard input buffer
5A	Resetting PATA/SATA bus and all devices
28	Testing memory
90	Resetting keyboard
94	Clearing keyboard input buffer
E7	Waiting for user input
01	INT 19
00	Ready to boot



# 5 Regulatory Compliance and Battery Disposal Information

---

## 5.1 Regulatory Compliance

This section contains the following regulatory compliance information for Intel Desktop Board DQ57TM:

- Safety standards
- European Union Declaration of Conformity statement
- Product Ecology statements
- Electromagnetic Compatibility (EMC) standards
- Product certification markings

### 5.1.1 Safety Standards

Intel Desktop Board DQ57TM complies with the safety standards stated in Table 45 when correctly installed in a compatible host system.

**Table 45. Safety Standards**

<b>Standard</b>	<b>Title</b>
CSA/UL 60950-1, First Edition	Information Technology Equipment – Safety - Part 1: General Requirements (USA and Canada)
EN 60950-1:2006, Second Edition	Information Technology Equipment – Safety - Part 1: General Requirements (European Union)
IEC 60950-1:2005, Second Edition	Information Technology Equipment – Safety - Part 1: General Requirements (International)

## 5.1.2 European Union Declaration of Conformity Statement

We, Intel Corporation, declare under our sole responsibility that the product Intel® Desktop Board DQ57TM is in conformity with all applicable essential requirements necessary for CE marking, following the provisions of the European Council Directive 2004/108/EC (EMC Directive) and 2006/95/EC (Low Voltage Directive).

The product is properly CE marked demonstrating this conformity and is for distribution within all member states of the EU with no restrictions.



This product follows the provisions of the European Directives 2004/108/EC and 2006/95/EC.

**Čeština** Tento výrobek odpovídá požadavkům evropských směrnic 2004/108/EC a 2006/95/EC.

**Dansk** Dette produkt er i overensstemmelse med det europæiske direktiv 2004/108/EC & 2006/95/EC.

**Dutch** Dit product is in navolging van de bepalingen van Europees Directief 2004/108/EC & 2006/95/EC.

**Eesti** Antud toode vastab Euroopa direktiivides 2004/108/EC ja 2006/95/EC kehtestatud nõuetele.

**Suomi** Tämä tuote noudattaa EU-direktiivin 2004/108/EC & 2006/95/EC määräyksiä.

**Français** Ce produit est conforme aux exigences de la Directive Européenne 2004/108/EC & 2006/95/EC.

**Deutsch** Dieses Produkt entspricht den Bestimmungen der Europäischen Richtlinie 2004/108/EC & 2006/95/EC.

**Ελληνικά** Το παρόν προϊόν ακολουθεί τις διατάξεις των Ευρωπαϊκών Οδηγιών 2004/108/EC και 2006/95/EC.

**Magyar** E termék megfelel a 2004/108/EC és 2006/95/EC Európai Irányelv előírásainak.

**Icelandic** Þessi vara stenst reglugerð Evrópska Efnahags Bandalagsins númer 2004/108/EC & 2006/95/EC.

**Italiano** Questo prodotto è conforme alla Direttiva Europea 2004/108/EC & 2006/95/EC.

**Latviešu** Šis produkts atbilst Eiropas Direktīvu 2004/108/EC un 2006/95/EC noteikumiem.

**Lietuvių** Šis produktas atitinka Europos direktyvų 2004/108/EC ir 2006/95/EC nuostatas.

**Malti** Dan il-prodott hu konformi mal-provvedimenti tad-Direttivi Ewropej 2004/108/EC u 2006/95/EC.

**Norsk** Dette produktet er i henhold til bestemmelsene i det europeiske direktivet 2004/108/EC & 2006/95/EC.

**Polski** Niniejszy produkt jest zgodny z postanowieniami Dyrektyw Unii Europejskiej 2004/108/EC i 73/23/EWG.

**Portuguese** Este produto cumpre com as normas da Diretiva Europeia 2004/108/EC & 2006/95/EC.

**Español** Este producto cumple con las normas del Directivo Europeo 2004/108/EC & 2006/95/EC.

**Slovensky** Tento produkt je v súlade s ustanoveniami európskych direktív 2004/108/EC a 2006/95/EC.

**Slovenščina** Izdelek je skladen z določbami evropskih direktiv 2004/108/EC in 2006/95/EC.

**Svenska** Denna produkt har tillverkats i enlighet med EG-direktiv 2004/108/EC & 2006/95/EC.

**Türkçe** Bu ürün, Avrupa Birliği'nin 2004/108/EC ve 2006/95/EC yönergelerine uyar.

### 5.1.3 Product Ecology Statements

The following information is provided to address worldwide product ecology concerns and regulations.

#### 5.1.3.1 Disposal Considerations

This product contains the following materials that may be regulated upon disposal: lead solder on the printed wiring board assembly.

#### 5.1.3.2 Recycling Considerations

As part of its commitment to environmental responsibility, Intel has implemented the Intel Product Recycling Program to allow retail consumers of Intel's branded products to return used products to selected locations for proper recycling.

Please consult the [http://www.intel.com/intel/other/ehs/product\\_ecology](http://www.intel.com/intel/other/ehs/product_ecology) for the details of this program, including the scope of covered products, available locations, shipping instructions, terms and conditions, etc.

#### 中文

作为其对环境责任之承诺的部分，英特尔已实施 Intel Product Recycling Program（英特尔产品回收计划），以允许英特尔品牌产品的零售消费者将使用过的产品退还至指定地点作恰当的重复使用处理。

请参考[http://www.intel.com/intel/other/ehs/product\\_ecology](http://www.intel.com/intel/other/ehs/product_ecology)了解此计划的详情，包括涉及产品之范围、回收地点、运送指导、条款和条件等。

#### Deutsch

Als Teil von Intels Engagement für den Umweltschutz hat das Unternehmen das Intel Produkt-Recyclingprogramm implementiert, das Einzelhandelskunden von Intel Markenprodukten ermöglicht, gebrauchte Produkte an ausgewählte Standorte für ordnungsgemäßes Recycling zurückzugeben.

Details zu diesem Programm, einschließlich der darin eingeschlossenen Produkte, verfügbaren Standorte, Versandanweisungen, Bedingungen usw., finden Sie auf der [http://www.intel.com/intel/other/ehs/product\\_ecology](http://www.intel.com/intel/other/ehs/product_ecology)

### **Español**

Como parte de su compromiso de responsabilidad medioambiental, Intel ha implantado el programa de reciclaje de productos Intel, que permite que los consumidores al detalle de los productos Intel devuelvan los productos usados en los lugares seleccionados para su correspondiente reciclado.

Consulte la [http://www.intel.com/intel/other/ehs/product\\_ecology](http://www.intel.com/intel/other/ehs/product_ecology) para ver los detalles del programa, que incluye los productos que abarca, los lugares disponibles, instrucciones de envío, términos y condiciones, etc.

### **Français**

Dans le cadre de son engagement pour la protection de l'environnement, Intel a mis en œuvre le programme Intel Product Recycling Program (Programme de recyclage des produits Intel) pour permettre aux consommateurs de produits Intel de recycler les produits usés en les retournant à des adresses spécifiées.

Visitez la page Web [http://www.intel.com/intel/other/ehs/product\\_ecology](http://www.intel.com/intel/other/ehs/product_ecology) pour en savoir plus sur ce programme, à savoir les produits concernés, les adresses disponibles, les instructions d'expédition, les conditions générales, etc.

### **日本語**

インテルでは、環境保護活動の一環として、使い終わったインテルブランド製品を指定の場所へ返送していただき、リサイクルを適切に行えるよう、インテル製品リサイクルプログラムを発足させました。

対象製品、返送先、返送方法、ご利用規約など、このプログラムの詳細情報は、[http://www.intel.com/intel/other/ehs/product\\_ecology](http://www.intel.com/intel/other/ehs/product_ecology) (英語)をご覧ください。

### **Malay**

Sebagai sebahagian daripada komitmennya terhadap tanggungjawab persekitaran, Intel telah melaksanakan Program Kitar Semula Produk untuk membenarkan pengguna-pengguna runcit produk jenama Intel memulangkan produk terguna ke lokasi-lokasi terpilih untuk dikitar semula dengan betul.

Sila rujuk [http://www.intel.com/intel/other/ehs/product\\_ecology](http://www.intel.com/intel/other/ehs/product_ecology) untuk mendapatkan butir-butir program ini, termasuklah skop produk yang dirangkumi, lokasi-lokasi tersedia, arahan penghantaran, terma & syarat, dsb.

### **Portuguese**

Como parte deste compromisso com o respeito ao ambiente, a Intel implementou o Programa de Reciclagem de Produtos para que os consumidores finais possam enviar produtos Intel usados para locais selecionados, onde esses produtos são reciclados de maneira adequada.

Consulte o site [http://www.intel.com/intel/other/ehs/product\\_ecology](http://www.intel.com/intel/other/ehs/product_ecology) (em Inglês) para obter os detalhes sobre este programa, inclusive o escopo dos produtos cobertos, os locais disponíveis, as instruções de envio, os termos e condições, etc.

### **Russian**

В качестве части своих обязательств к окружающей среде, в Intel создана программа утилизации продукции Intel (Product Recycling Program) для предоставления конечным пользователям марок продукции Intel возможности возврата используемой продукции в специализированные пункты для должной утилизации.

Пожалуйста, обратитесь на веб-сайт [http://www.intel.com/intel/other/ehs/product\\_ecology](http://www.intel.com/intel/other/ehs/product_ecology) за информацией об этой программе, принимаемых продуктах, местах приема, инструкциях об отправке, положениях и условиях и т.д.

### **Türkçe**

Intel, çevre sorumluluğuna bağlılığının bir parçası olarak, perakende tüketicilerin Intel markalı kullanılmış ürünlerini belirlenmiş merkezlere iade edip uygun şekilde geri dönüştürmesini amaçlayan Intel Ürünleri Geri Dönüşüm Programı'nı uygulamaya koymuştur.

Bu programın ürün kapsamı, ürün iade merkezleri, nakliye talimatları, kayıtlar ve şartlar v.s dahil bütün ayrıntılarını öğrenmek için lütfen [http://www.intel.com/intel/other/ehs/product\\_ecology](http://www.intel.com/intel/other/ehs/product_ecology)

Web sayfasına gidin.

### **5.1.3.3 Lead Free Desktop Board**



This Intel Desktop Board is a European Union Restriction of Hazardous Substances (EU RoHS Directive 2002/95/EC) compliant product. EU RoHS restricts the use of six materials. One of the six restricted materials is lead.

This Intel Desktop Board is lead free although certain discrete components used on the board contain a small amount of lead which is necessary for component performance and/or reliability. This Intel Desktop Board is referred to as "Lead-free second level interconnect." The board substrate and the solder connections from the board to the components (second-level connections) are all lead free.

China bans the same substances and has the same limits as EU RoHS; however it requires different product marking and controlled substance information. The required mark shows the Environmental Friendly Usage Period (EFUP). The EFUP is defined as the number of years for which controlled listed substances will not leak or chemically deteriorate while in the product.

Table 46 shows the various forms of the "Lead-Free 2<sup>nd</sup> Level Interconnect" mark as it appears on the board and accompanying collateral.

**Table 46. Lead-Free Board Markings**

Description	Mark
<p>Lead-Free 2<sup>nd</sup> Level Interconnect:                      This symbol is used to identify electrical and electronic assemblies and components in which the lead (Pb) concentration level in the desktop board substrate and the solder connections from the board to the components (second-level interconnect) is not greater than 0.1% by weight (1000 ppm).</p>	
	<p>or</p>
	
	<p>or</p> 



## 5.1.4 EMC Regulations

Intel Desktop Board DQ57TM complies with the EMC regulations stated in Table 47 when correctly installed in a compatible host system.

**Table 47. EMC Regulations**

Regulation	Title
FCC 47 CFR Part 15, Subpart B	Title 47 of the Code of Federal Regulations, Part15, Subpart B, Radio Frequency Devices. (USA)
ICES-003 Issue 4	Interference-Causing Equipment Standard, Digital Apparatus. (Canada)
EN55022:2006	Limits and methods of measurement of Radio Interference Characteristics of Information Technology Equipment. (European Union)
EN55024:1998	Information Technology Equipment – Immunity Characteristics Limits and methods of measurement. (European Union)
EN55022:2006	Australian Communications Authority, Standard for Electromagnetic Compatibility. (Australia and New Zealand)
CISPR 22:2005 +A1:2005 +A2:2006	Limits and methods of measurement of Radio Disturbance Characteristics of Information Technology Equipment. (International)
CISPR 24:1997 +A1:2001 +A2:2002	Information Technology Equipment – Immunity Characteristics – Limits and Methods of Measurement. (International)
VCCI V-3/2007.04, V-4/2007.04	Voluntary Control for Interference by Information Technology Equipment. (Japan)
KN-22, KN-24	Korean Communications Commission – Framework Act on Telecommunications and Radio Waves Act (South Korea)
CNS 13438:2006	Bureau of Standards, Metrology and Inspection (Taiwan)

Japanese Kanji statement translation: this is a Class B product based on the standard of the Voluntary Control Council for Interference from Information Technology Equipment (VCCI). If this is used near a radio or television receiver in a domestic environment, it may cause radio interference. Install and use the equipment according to the instruction manual.

この装置は、情報処理装置等電波障害自主規制協議会（VCCI）の基準に基づくクラスB情報技術装置です。この装置は、家庭環境で使用することを目的としていますが、この装置がラジオやテレビジョン受信機に近接して使用されると、受信障害を引き起こすことがあります。  
取扱説明書に従って正しい取り扱いをして下さい。









Korean Class B statement translation: this is household equipment that is certified to comply with EMC requirements. You may use this equipment in residential environments and other non-residential environments.

이 기기는 가정용으로 전자파적합등록을 한 기기로서  
주거지역에서는 물론 모든 지역에서 사용할 수 있습니다.

### 5.1.5 Product Certification Markings (Board Level)

Intel Desktop Board DQ57TM has the product certification markings shown in Table 48:

**Table 48. Product Certification Markings**

Description	Mark
UL joint US/Canada Recognized Component mark. Includes adjacent UL file number for Intel desktop boards: E210882.	
FCC Declaration of Conformity logo mark for Class B equipment. Includes Intel name and DQ57TM model designation.	
CE mark. Declaring compliance to European Union (EU) EMC directive and Low Voltage directive.	
Australian Communications Authority (ACA) and New Zealand Radio Spectrum Management (NZ RSM) C-tick mark. Includes adjacent Intel supplier code number, N-232.	
Japan VCCI (Voluntary Control Council for Interference) mark.	
S. Korea KCC (Korean Communications Commission) mark. Includes adjacent KCC certification number: CPU-DQ57TM (B)	
Taiwan BSMI (Bureau of Standards, Metrology and Inspections) mark. Includes adjacent Intel company number, D33025.	
Printed wiring board manufacturer's recognition mark. Consists of a unique UL recognized manufacturer's logo, along with a flammability rating (solder side).	V-0
China RoHS/Environmentally Friendly Use Period Logo: This is an example of the symbol used on Intel Desktop Boards and associated collateral. The color of the mark may vary depending upon the application. The Environmental Friendly Usage Period (EFUP) for Intel Desktop Boards has been determined to be 10 years.	

## 5.2 Battery Disposal Information



### CAUTION

*Risk of explosion if the battery is replaced with an incorrect type. Batteries should be recycled where possible. Disposal of used batteries must be in accordance with local environmental regulations.*



### PRECAUTION

*Risque d'explosion si la pile usagée est remplacée par une pile de type incorrect. Les piles usagées doivent être recyclées dans la mesure du possible. La mise au rebut des piles usagées doit respecter les réglementations locales en vigueur en matière de protection de l'environnement.*



### FORHOLDSREGEL

*Eksplodingsfare, hvis batteriet erstattes med et batteri af en forkert type. Batterier bør om muligt genbruges. Bortskaffelse af brugte batterier bør foregå i overensstemmelse med gældende miljølovgivning.*



### OBS!

*Det kan oppstå eksplosjonsfare hvis batteriet skiftes ut med feil type. Brukte batterier bør kastes i henhold til gjeldende miljølovgivning.*



### VIKTIGT!

*Risk för explosion om batteriet ersätts med felaktig batterityp. Batterier ska kasseras enligt de lokala miljövårdsbestämmelserna.*



### VARO

*Räjähdyksvaara, jos pariston tyyppi on väärä. Paristot on kierrätettävä, jos se on mahdollista. Käytetyt paristot on hävitettävä paikallisten ympäristömääräysten mukaisesti.*



### VORSICHT

*Bei falschem Einsetzen einer neuen Batterie besteht Explosionsgefahr. Die Batterie darf nur durch denselben oder einen entsprechenden, vom Hersteller empfohlenen Batterietyp ersetzt werden. Entsorgen Sie verbrauchte Batterien den Anweisungen des Herstellers entsprechend.*



### AVVERTIMENTO

*Esiste il pericolo di un esplosione se la pila non viene sostituita in modo corretto. Utilizzare solo pile uguali o di tipo equivalente a quelle consigliate dal produttore. Per disfarsi delle pile usate, seguire le istruzioni del produttore.*



## PRECAUCIÓN

*Existe peligro de explosión si la pila no se cambia de forma adecuada. Utilice solamente pilas iguales o del mismo tipo que las recomendadas por el fabricante del equipo. Para deshacerse de las pilas usadas, siga igualmente las instrucciones del fabricante.*



## WAARSCHUWING

*Er bestaat ontploffingsgevaar als de batterij wordt vervangen door een onjuist type batterij. Batterijen moeten zoveel mogelijk worden gerecycled. Houd u bij het weggooien van gebruikte batterijen aan de plaatselijke milieuwetgeving.*



## ATENÇÃO

*Haverá risco de explosão se a bateria for substituída por um tipo de bateria incorreto. As baterias devem ser recicladas nos locais apropriados. A eliminação de baterias usadas deve ser feita de acordo com as regulamentações ambientais da região.*



## AŠCIAROŽNÁŠĆ

*Існуе рызыка выбуху, калі заменены акумулятар неправільнага тыпу. Акумулятары павінны, па магчымасці, перепрацоўвацца. Пазбаўляцца ад старых акумулятараў патрэбна згодна з мясцовым заканадаўствам па экалогіі.*



## UPOZORNĚNÍ

*V případě výměny baterie za nesprávný druh může dojít k výbuchu. Je-li to možné, baterie by měly být recyklovány. Baterie je třeba zlikvidovat v souladu s místními předpisy o životním prostředí.*



## Προσοχή

*Υπάρχει κίνδυνος για έκρηξη σε περίπτωση που η μπαταρία αντικατασταθεί από μία λανθασμένου τύπου. Οι μπαταρίες θα πρέπει να ανακυκλώνονται όταν κάτι τέτοιο είναι δυνατό. Η απόρριψη των χρησιμοποιημένων μπαταριών πρέπει να γίνεται σύμφωνα με τους κατά τόπο περιβαλλοντικούς κανονισμούς.*



## VIGYAZAT

*Ha a telepet nem a megfelelő típusú telepre cseréli, az felrobbanhat. A telepeket lehetőség szerint újra kell hasznosítani. A használt telepeket a helyi környezetvédelmi előírásoknak megfelelően kell kiselejtezni.*



## 注意

異なる種類の電池を使用すると、爆発の危険があります。リサイクルが可能な地域であれば、電池をリサイクルしてください。使用後の電池を破棄する際には、地域の環境規制に従ってください。



### AWAS

*Risiko letupan wujud jika bateri digantikan dengan jenis yang tidak betul. Bateri sepatutnya dikitar semula jika boleh. Pelupusan bateri terpakai mestilah mematuhi peraturan alam sekitar tempatan.*



### OSTRZEŻENIE

*Istnieje niebezpieczeństwo wybuchu w przypadku zastosowania niewłaściwego typu baterii. Zużyte baterie należy w miarę możliwości utylizować zgodnie z odpowiednimi przepisami ochrony środowiska.*



### PRECAUȚIE

*Risc de explozie, dacă bateria este înlocuită cu un tip de baterie necorespunzător. Bateriile trebuie reciclate, dacă este posibil. Depozitarea bateriilor uzate trebuie să respecte reglementările locale privind protecția mediului.*



### ВНИМАНИЕ

*При использовании батареи несоответствующего типа существует риск ее взрыва. Батареи должны быть утилизированы по возможности. Утилизация батарей должна проводиться по правилам, соответствующим местным требованиям.*



### UPOZORNENIE

*Ak batériu vymeníte za nesprávny typ, hrozí nebezpečenstvo jej výbuchu. Batérie by sa mali podľa možnosti vždy recyklovať. Likvidácia použitých batérií sa musí vykonávať v súlade s miestnymi predpismi na ochranu životného prostredia.*



### POZOR

*Zamenjava baterije z baterijo drugačnega tipa lahko povzroči eksplozijo. Če je mogoče, baterije reciklirajte. Rabljene baterije zavrzite v skladu z lokalnimi okoljevarstvenimi predpisi.*



### คำเตือน

*ระวังการระเบิดที่เกิดจากเปลี่ยนแบตเตอรี่ผิดประเภท หากเป็นไปได้ ควรนำแบตเตอรี่ไปรีไซเคิล การทิ้งแบตเตอรี่ใช้แล้วต้องเป็นไปตามกฎข้อบังคับด้านสิ่งแวดล้อมของท้องถิ่น.*



### UYARI

*Yanlış türde pil takıldığında patlama riski vardır. Piller mümkün olduğunda geri dönüştürülmelidir. Kullanılmış piller, yerel çevre yasalarına uygun olarak atılmalıdır.*



### ОСТОРОГА

*Використовуйте батареї правильного типу, інакше існуватиме ризик вибуху. Якщо можливо, використані батареї слід утилізувати. Утилізація використаних батарей має бути виконана згідно місцевих норм, що регулюють охорону довкілля.*



### **UPOZORNĚNÍ**

*V případě výměny baterie za nesprávný druh může dojít k výbuchu. Je-li to možné, baterie by měly být recyklovány. Baterie je třeba zlikvidovat v souladu s místními předpisy o životním prostředí.*



### **ETTEVAATUST**

*Kui patarei asendatakse uue ebasobivat tüüpi patareiga, võib tekkida plahvatusoht. Tühjad patareid tuleb võimaluse korral viia vastavasse kogumispunkti. Tühjade patareide äraviskamisel tuleb järgida kohalikke keskkonnakaitse alaseid reegleid.*



### **FIGYELMEZTETÉS**

*Ha az elemet nem a megfelelő típusúra cseréli, felrobbanhat. Az elemeket lehetőség szerint újra kell hasznosítani. A használt elemeket a helyi környezetvédelmi előírásoknak megfelelően kell kiselejtezni.*



### **UZMANĪBU**

*Pastāv eksplozijas risks, ja baterijas tiek nomainītas ar nepareiza veida baterijām. Ja iespējams, baterijas vajadzētu nodot attiecīgos pieņemšanas punktus. Bateriju izmešanai atkritumos jānotiek saskaņā ar vietējiem vides aizsardzības noteikumiem.*



### **DĒMESIO**

*Naudojant netinkamo tipo baterijas įrenginys gali sprogti. Kai tik įmanoma, baterijas reikia naudoti pakartotinai. Panaudotas baterijas išmesti būtina pagal vietinius aplinkos apsaugos nuostatus.*



### **ATTENZJONI**

*Riskju ta' splużjoni jekk il-batterija tinbidel b'tip ta' batterija mhux korrett. Il-batteriji għandhom jiġu riċiklati fejn hu possibbli. Ir-rimi ta' batteriji użati għandu jsir skond ir-regolamenti ambjentali lokali.*



### **OSTRZEŻENIE**

*Ryzyko wybuchu w przypadku wymiany na baterie niewłaściwego typu. W miarę możliwości baterie należy poddać recyklingowi. Zużytych baterii należy pozbywać się zgodnie z lokalnie obowiązującymi przepisami w zakresie ochrony środowiska.*