

Intel® Desktop Board DH61CR Technical Product Specification

May 2011

Part Number: G23549-002

The Intel® Desktop Board DH61CR may contain design defects or errors known as errata that may cause the product to deviate from published specifications. Current characterized errata are documented in the Intel Desktop Board DH61CR Specification Update.

Revision History

Revision	Revision History	Date
-001	First release of the Intel® Desktop Board DH61CR Technical Product Specification	February 2011
-002	Second release of the Intel® Desktop Board DH61CR Technical Product Specification	May 2011

Disclaimer

This product specification applies to only the standard Intel® Desktop Board DH61CR with BIOS identifier BEH6110H.86A.

INFORMATION IN THIS DOCUMENT IS PROVIDED IN CONNECTION WITH INTEL® PRODUCTS. NO LICENSE, EXPRESS OR IMPLIED, BY ESTOPPEL OR OTHERWISE, TO ANY INTELLECTUAL PROPERTY RIGHTS IS GRANTED BY THIS DOCUMENT. EXCEPT AS PROVIDED IN INTEL'S TERMS AND CONDITIONS OF SALE FOR SUCH PRODUCTS, INTEL ASSUMES NO LIABILITY WHATSOEVER, AND INTEL DISCLAIMS ANY EXPRESS OR IMPLIED WARRANTY, RELATING TO SALE AND/OR USE OF INTEL PRODUCTS INCLUDING LIABILITY OR WARRANTIES RELATING TO FITNESS FOR A PARTICULAR PURPOSE, MERCHANTABILITY, OR INFRINGEMENT OF ANY PATENT, COPYRIGHT OR OTHER INTELLECTUAL PROPERTY RIGHT. UNLESS OTHERWISE AGREED IN WRITING BY INTEL, THE INTEL PRODUCTS ARE NOT DESIGNED NOR INTENDED FOR ANY APPLICATION IN WHICH THE FAILURE OF THE INTEL PRODUCT COULD CREATE A SITUATION WHERE PERSONAL INJURY OR DEATH MAY OCCUR.

All Intel® desktop boards are evaluated as Information Technology Equipment (I.T.E.) for use in personal computers (PC) for installation in homes, offices, schools, computer rooms, and similar locations. The suitability of this product for other PC or embedded non-PC applications or other environments, such as medical, industrial, alarm systems, test equipment, etc. may not be supported without further evaluation by Intel.

Intel Corporation may have patents or pending patent applications, trademarks, copyrights, or other intellectual property rights that relate to the presented subject matter. The furnishing of documents and other materials and information does not provide any license, express or implied, by estoppel or otherwise, to any such patents, trademarks, copyrights, or other intellectual property rights.

Intel may make changes to specifications and product descriptions at any time, without notice.

Designers must not rely on the absence or characteristics of any features or instructions marked "reserved" or "undefined." Intel reserves these for future definition and shall have no responsibility whatsoever for conflicts or incompatibilities arising from future changes to them.

Intel desktop boards may contain design defects or errors known as errata, which may cause the product to deviate from published specifications. Current characterized errata are available on request.

Intel, Intel Core, and Pentium are trademarks of Intel Corporation in the U.S. and/or other countries.

* Other names and brands may be claimed as the property of others.

Copyright © 2011, Intel Corporation. All rights reserved.

Board Identification Information

Basic Desktop Board DH61CR Identification Information

AA Revision	BIOS Revision	Notes
G14064-202	BEH6110H.86A.0016	1,2
G14065-203	BEH6110H.86A.0016	1,2

Notes:

1. The AA number is found on a small label on the component side of the board.
2. The H61 processor used on this AA revision consists of the following component:

Device	Stepping	S-Spec Numbers
82H61	B3	SLJ4B

Specification Changes or Clarifications

The table below indicates the Specification Changes or Specification Clarifications that apply to the Intel® Desktop Board DH61CR.

Specification Changes or Clarifications

Date	Type of Change	Description of Change or Clarification
May 2011	Spec Clarifications	<ul style="list-style-type: none"> • The Intel H61 Express Chipset does not support RAID. The following sections of this manual have been updated: <ul style="list-style-type: none"> – Reference to RAID in Table 1. Feature Summary has been deleted – Section 1.9.1.1 Serial ATA RAID has been deleted – Section 1.9.1.2 Intel® Rapid Recover Technology has been deleted – The Caution in Section 3.1 Introduction has been deleted • The maximum memory supported changed from 16 GB to 8 GB in the following sections of this manual: <ul style="list-style-type: none"> – Table 1. Feature Summary – Section 1.6 System Memory – Section 2.1.1 Addressable Memory – Figure 8. Detailed System Memory Address Map – Table 9. System Memory Map • The Korean Certification mark has changed. The following sections of this manual have been updated: <ul style="list-style-type: none"> – Section 5.1.4 EMC Regulations. The Korean Class B Statement translation has been updated. – Section 5.1.6 Regulatory Compliance Marks (Board Level). The new Korean Certification mark has been added.

Errata

Current characterized errata, if any, are documented in a separate Specification Update. See <http://developer.intel.com/products/desktop/motherboard/index.htm> for the latest documentation.

Preface

This Technical Product Specification (TPS) specifies the board layout, components, connectors, power and environmental requirements, and the BIOS for the Intel® Desktop Board DH61CR.

Intended Audience

The TPS is intended to provide detailed, technical information about the Intel Desktop Board DH61CR and its components to the vendors, system integrators, and other engineers and technicians who need this level of information. It is specifically *not* intended for general audiences.

What This Document Contains

Chapter	Description
1	A description of the hardware used on the Intel Desktop Board DH61CR
2	A map of the resources of the Intel Desktop Board
3	The features supported by the BIOS Setup program
4	A description of the BIOS error messages, beep codes, and POST codes
5	Regulatory compliance and battery disposal information

Typographical Conventions

This section contains information about the conventions used in this specification. Not all of these symbols and abbreviations appear in all specifications of this type.

Notes, Cautions, and Warnings



NOTE

Notes call attention to important information.



CAUTION

Cautions are included to help you avoid damaging hardware or losing data.

Other Common Notation

#	Used after a signal name to identify an active-low signal (such as USBP0#)
GB	Gigabyte (1,073,741,824 bytes)
GB/s	Gigabytes per second
Gb/s	Gigabits per second
KB	Kilobyte (1024 bytes)
Kbit	Kilobit (1024 bits)
kbits/s	1000 bits per second
MB	Megabyte (1,048,576 bytes)
MB/s	Megabytes per second
Mbit	Megabit (1,048,576 bits)
Mbits/s	Megabits per second
xxh	An address or data value ending with a lowercase h indicates a hexadecimal value.
x.x V	Volts. Voltages are DC unless otherwise specified.
*	This symbol is used to indicate third-party brands and names that are the property of their respective owners.

Contents

Revision History

Disclaimer	ii
Board Identification Information	iii
Specification Changes or Clarifications	iii
Errata	iv

Preface

Intended Audience	v
What This Document Contains	v
Typographical Conventions	v

1 Product Description

1.1 Overview	11
1.1.1 Feature Summary	11
1.1.2 Board Layout	13
1.1.3 Block Diagram	15
1.2 Legacy Considerations	16
1.3 Online Support	16
1.4 Processor	16
1.5 Intel® H61 Express Chipset	17
1.6 System Memory	17
1.6.1 Memory Configurations	18
1.7 Graphics Subsystem	20
1.7.1 Integrated Graphics	20
1.7.2 PCI Express x16 Graphics	20
1.8 USB	21
1.9 SATA Interfaces	21
1.10 Legacy I/O Controller	22
1.10.1 Serial Port	22
1.11 Audio Subsystem	23
1.11.1 Audio Subsystem Software	24
1.11.2 Audio Headers and Connectors	24
1.12 LAN Subsystem	26
1.12.1 Intel® 82579V Gigabit Ethernet Controller	26
1.12.2 LAN Subsystem Software	26
1.12.3 RJ-45 LAN Connector with Integrated LEDs	27
1.13 Real-Time Clock Subsystem	28
1.14 Thermal Monitoring	29
1.15 Platform Management and Security	30
1.15.1 Hardware Management Subsystem	30
1.15.2 Hardware Monitoring	30

1.16 Power Management	31
1.16.1 ACPI.....	31
1.16.2 Hardware Support	34

2 Technical Reference

2.1 Memory Resources	39
2.1.1 Addressable Memory.....	39
2.1.2 Memory Map.....	41
2.2 Connectors and Headers.....	41
2.2.1 Back Panel Connectors	42
2.2.2 Component-side Connectors and Headers	43
2.3 BIOS Configuration Jumper Block.....	52
2.4 Intel® Management Engine BIOS Extension (Intel® MEBX) Reset Header .	54
2.5 Mechanical Considerations	55
2.5.1 Form Factor.....	55
2.6 Electrical Considerations.....	56
2.6.1 Power Supply Considerations	56
2.6.2 Fan Header Current Capability.....	57
2.6.3 Add-in Board Considerations	57
2.7 Thermal Considerations	58
2.8 Reliability	60
2.9 Environmental	60

3 Overview of BIOS Features

3.1 Introduction	61
3.2 System Management BIOS (SMBIOS).....	63
3.3 Legacy USB Support	63
3.4 BIOS Updates	64
3.4.1 Language Support.....	64
3.4.2 Custom Splash Screen	65
3.5 BIOS Recovery.....	65
3.6 Boot Options.....	66
3.6.1 Optical Drive Boot	66
3.6.2 Network Boot.....	66
3.6.3 Booting Without Attached Devices.....	66
3.6.4 Changing the Default Boot Device During POST	66

4 Error Messages and Beep Codes

4.1 Speaker	67
4.2 BIOS Beep Codes	67
4.3 Front-panel Power LED Blink Codes	68
4.4 BIOS Error Messages	68
4.5 Port 80h POST Codes	69

5 Regulatory Compliance and Battery Disposal Information

5.1	Regulatory Compliance.....	75
5.1.1	Safety Standards.....	75
5.1.2	European Union Declaration of Conformity Statement.....	76
5.1.3	Product Ecology Statements.....	77
5.1.4	EMC Regulations	79
5.1.5	ENERGY STAR* 5.0, e-Standby, and ErP Compliance	82
5.1.6	Regulatory Compliance Marks (Board Level)	83
5.2	Battery Disposal Information.....	84

Figures

1.	Major Board Components.....	13
2.	Block Diagram	15
3.	Memory Channel and DIMM Configuration	19
4.	Back Panel Audio Connector Options	25
5.	LAN Connector LED Locations.....	27
6.	Thermal Sensors and Fan Headers	29
7.	Location of the Standby Power LED (Green)	37
8.	Detailed System Memory Address Map	40
9.	Back Panel Connectors	42
10.	Component-side Connectors and Headers	43
11.	Connection Diagram for Front Panel Header	49
12.	Connection Diagram for Front Panel USB Headers	51
13.	Location of the Jumper Block.....	52
14.	Intel MEBX Reset Header	54
15.	Board Dimensions	55
16.	Localized High Temperature Zones.....	59

Tables

1.	Feature Summary.....	11
2.	Components Shown in Figure 1	14
3.	Supported Memory Configurations	18
4.	Audio Jack Support.....	23
5.	LAN Connector LED States	27
6.	Effects of Pressing the Power Switch	31
7.	Power States and Targeted System Power.....	32
8.	Wake-up Devices and Events	33
9.	System Memory Map	41
10.	Component-side Connectors and Headers Shown in Figure 10.....	44
11.	TPM Header	45
12.	Serial Port Header	45
13.	S/PDIF Header	45
14.	Internal Mono Speaker Header	45
15.	Front Panel Audio Header for Intel HD Audio.....	46
16.	Front Panel Audio Header for AC '97 Audio	46

Intel Desktop Board DH61CR Technical Product Specification

17.	Front Panel USB Header	46
18.	SATA Connectors.....	46
19.	Chassis Intrusion Header	47
20.	Fan Headers	47
21.	Processor Core Power Connector.....	48
22.	Main Power Connector.....	48
23.	Front Panel Header	49
24.	States for a One-Color Power LED	50
25.	Alternate Front Panel Power LED Header	50
26.	LPC Debug Header.....	51
27.	BIOS Setup Configuration Jumper Settings.....	53
28.	Intel MEBX Reset Header Signals	54
29.	Recommended Power Supply Current Values	56
30.	Fan Header Current Capability	57
31.	Thermal Considerations for Components	59
32.	Environmental Specifications.....	60
33.	BIOS Setup Program Menu Bar.....	62
34.	BIOS Setup Program Function Keys.....	62
35.	Acceptable Drives/Media Types for BIOS Recovery	65
36.	Boot Device Menu Options	66
37.	BIOS Beep Codes	67
38.	Front-panel Power LED Blink Codes	68
39.	BIOS Error Messages	68
40.	Port 80h POST Code Ranges.....	69
41.	Port 80h POST Codes	70
42.	Typical Port 80h POST Sequence.....	74
43.	Safety Standards.....	75
44.	EMC Regulations	79
45.	Regulatory Compliance Marks.....	83

1 Product Description

1.1 Overview

1.1.1 Feature Summary

Table 1 summarizes the major features of the board.

Table 1. Feature Summary

Form Factor	MicroATX (9.60 inches by 7.80 inches [243.84 millimeters by 198.12 millimeters])
Processor	<ul style="list-style-type: none">• Intel® Core™ i7, Intel® Core™ i5, Intel® Core™ i3, and Intel® Pentium® processors in an LGA1155 socket with up to 95 W TDP:<ul style="list-style-type: none">– Integrated graphics processing (processors with Intel® Graphics Technology)– External graphics interface controller– Integrated memory controller
Chipset	Intel® H61 Express Chipset consisting of the Intel® H61 Platform Controller Hub (PCH)
Memory	<ul style="list-style-type: none">• Two 240-pin DDR3 SDRAM Dual Inline Memory Module (DIMM) sockets• Support for DDR3 1333 MHz and DDR3 1066 MHz DIMMs• Support for 1 Gb, 2 Gb, and 4 Gb memory technology• Support for up to 8 GB of system memory with two DIMMs using 4 Gb memory technology• Support for non-ECC memory
Graphics	<ul style="list-style-type: none">• Integrated graphics support for processors with Intel® Graphics Technology:<ul style="list-style-type: none">– VGA– DVI-D• Discrete graphics support for PCI Express 2.0 x16 add-in graphics card
Audio	<ul style="list-style-type: none">• Intel® High Definition Audio:<ul style="list-style-type: none">– Realtek* ALC892 audio codec– S/PDIF audio header– Front panel audio header– Mono speaker header

continued

Table 1. Feature Summary (continued)

Peripheral Interfaces	<ul style="list-style-type: none"> • Ten USB ports: <ul style="list-style-type: none"> — Four USB 2.0 ports are implemented with stacked back panel connectors — Six USB 2.0 front panel ports are implemented through three dual-port internal headers • Four SATA interfaces through the Intel H61 Express Chipset • One serial port header • One parallel port connector on the back panel • One PS/2* keyboard/mouse port on back panel
Legacy I/O Control	<ul style="list-style-type: none"> • Nuvoton* W83677HG-i Super I/O controller for hardware management and serial port, parallel port, and PS/2 support
BIOS	<ul style="list-style-type: none"> • Intel® BIOS resident in the SPI Flash device • Support for Advanced Configuration and Power Interface (ACPI), Plug and Play, and SMBIOS
Instantly Available PC Technology	<ul style="list-style-type: none"> • Support for PCI* Local Bus Specification Revision 2.2 • Support for PCI Express* • Suspend to RAM support • Wake on Conventional PCI, PCI Express, LAN, front panel, serial, PS/2, and USB ports
LAN Support	<p>Gigabit (10/100/1000 Mbps/s) LAN subsystem using the Intel® 82579V Gigabit Ethernet Controller</p>
Expansion Capabilities	<ul style="list-style-type: none"> • One PCI Express 2.0 x16 add-in card connector • Two PCI Express 2.0 x1 add-in card connectors • One Conventional PCI bus connector
Hardware Monitor Subsystem	<ul style="list-style-type: none"> • Hardware monitoring through the Nuvoton Super I/O controller • Voltage sense to detect out of range power supply voltages • Thermal sense to detect out of range thermal values • Three fan headers • Two fan sense inputs used to monitor fan activity • Fan speed control

Table 2. Components Shown in Figure 1

Item/callout from Figure 1	Description
A	Conventional PCI bus add-in card connector
B	PCI Express x1 add-in card connector
C	Chassis intrusion header
D	S/PDIF header
E	PCI Express x1 add-in card connector
F	Battery
G	PCI Express x16 add-in card connector
H	Back panel connectors
I	Standby power LED
J	12 V internal power connector (ATX12V)
K	Rear chassis fan header
L	Piezoelectric speaker
M	LGA1155 processor socket
N	Processor fan header
O	Front chassis fan header
P	Low Pin Count (LPC) Debug header
Q	DIMM 1 (Channel A DIMM 1)
R	DIMM 2 (Channel B DIMM 1)
S	Trusted Platform Module (TPM) header
T	Main power connector (2 x 12)
U	SATA connectors
V	BIOS setup configuration jumper block
W	Front panel header
X	Alternate front panel power LED header
Y	Intel® Management Engine BIOS Extension (Intel® MEBX) Reset header
Z	Intel H61 Express Chipset
AA	Serial port header
BB	Front panel USB 2.0 headers (3)
CC	Internal mono speaker header
DD	Front panel audio header

1.1.3 Block Diagram

Figure 2 is a block diagram of the major functional areas of the board.

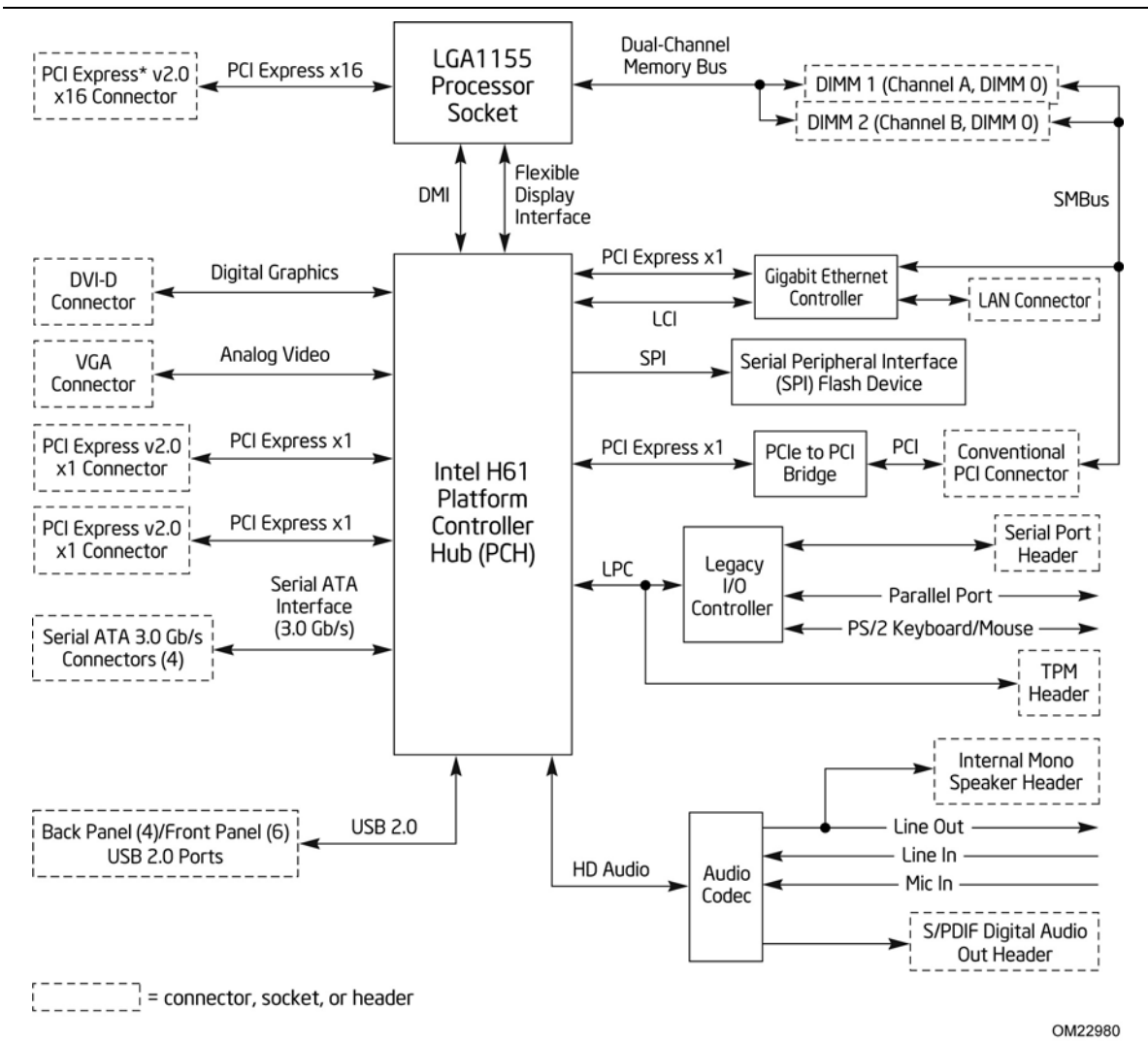

Figure 2. Block Diagram

1.2 Legacy Considerations

This board differs from other Intel Desktop Board products, with specific changes including (but not limited to) the following:

- No Parallel ATA (PATA) IDE drive connector

1.3 Online Support

To find information about...	Visit this World Wide Web site:
Intel Desktop Board DH61CR	http://www.intel.com/products/motherboard/index.htm
Desktop Board Support	http://www.intel.com/p/en_US/support?iid=hdr+support
Available configurations for the Intel Desktop Board DH61CR	http://ark.intel.com
Supported processors	http://processormatch.intel.com
Chipset information	http://www.intel.com/products/desktop/chipsets/index.htm
BIOS and driver updates	http://downloadcenter.intel.com
Tested memory	http://www.intel.com/support/motherboards/desktop/sb/CS-025414.htm
Integration information	http://www.intel.com/support/go/buildit

1.4 Processor

The board is designed to support the Intel Core i7, Intel Core i5, Intel Core i3, and Intel Pentium processors in an LGA1155 socket.

Other processors may be supported in the future. This board is designed to support processors with a maximum TDP of 95 W. See the Intel web site listed below for the most up-to-date list of supported processors.

For information about...	Refer to:
Supported processors	http://processormatch.intel.com



CAUTION

Use only the processors listed on the web site above. Use of unsupported processors can damage the board, the processor, and the power supply.



NOTE

This board has specific requirements for providing power to the processor. Refer to Section 2.6.1 on page 56 for information on power supply requirements for this board.

1.5 Intel® H61 Express Chipset

The Intel H61 Express Chipset consisting of the Intel H61 Platform Controller Hub (PCH) provides interfaces to the processor and the USB, SATA, LPC, audio, network, display, and PCI Express. The PCH is a centralized controller for the board's I/O paths.

For information about	Refer to
The Intel H61 Express chipset	http://www.intel.com/products/desktop/chipsets/index.htm
Resources used by the chipset	Chapter 2

1.6 System Memory

The board has two DIMM sockets and supports the following memory features:

- Two independent memory channels with interleaved mode support
- Supports 1.2 V – 1.8 V DIMM memory voltage
- Support for non-ECC, unbuffered, single-sided or double-sided DIMMs with x8 organization
- 8 GB maximum total system memory (with 4 Gb memory technology). Refer to Section 2.1.1 on page 39 for information on the total amount of addressable memory.
- Minimum total system memory: 1 GB using 1 Gb x8 module
- Serial Presence Detect
- DDR3 1333 MHz and DDR3 1066 MHz SDRAM DIMMs



NOTE

To be fully compliant with all applicable DDR SDRAM memory specifications, the board should be populated with DIMMs that support the Serial Presence Detect (SPD) data structure. This allows the BIOS to read the SPD data and program the chipset to accurately configure memory settings for optimum performance. If non-SPD memory is installed, the BIOS will attempt to correctly configure the memory settings, but performance and reliability may be impacted or the DIMMs may not function under the determined frequency.

Table 3 lists the supported DIMM configurations.

Table 3. Supported Memory Configurations

DIMM Capacity	Configuration ^(Note)	SDRAM Density	SDRAM Organization Front-side/Back-side	Number of SDRAM Devices
512 MB	SS	1 Gbit	64 M x16/empty	4
1024 MB	SS	1 Gbit	128 M x8/empty	8
1024 MB	SS	2 Gbit	128 M x16/empty	4
2048 MB	DS	1 Gbit	128 M x8/128 M x8	16
2048 MB	SS	2 Gbit	128 M x16/empty	8
4096 MB	DS	2 Gbit	256 M x8/256 M x8	16
4096 MB	SS	4 Gbit	512 M x8/empty	8

Note: "DS" refers to double-sided memory modules (containing two rows of SDRAM) and "SS" refers to single-sided memory modules (containing one row of SDRAM).

For information about...	Refer to:
Tested Memory	http://support.intel.com/support/motherboards/desktop/sb/CS-025414.htm

1.6.1 Memory Configurations

The Intel Core i7, Intel Core i5, Intel Core i3, and Intel Pentium processors support the following types of memory organization:

- **Dual channel (Interleaved) mode.** This mode offers the highest throughput for real world applications. Dual channel mode is enabled when the installed memory capacities of both DIMM channels are equal. Technology and device width can vary from one channel to the other but the installed memory capacity for each channel must be equal. If different speed DIMMs are used between channels, the slowest memory timing will be used.
- **Single channel (Asymmetric) mode.** This mode is equivalent to single channel bandwidth operation for real world applications. This mode is used when only a single DIMM is installed or the memory capacities are unequal. Technology and device width can vary from one channel to the other. If different speed DIMMs are used between channels, the slowest memory timing will be used.

For information about...	Refer to:
Memory Configuration examples	http://www.intel.com/support/motherboards/desktop/sb/cs-011965.htm

Figure 3 illustrates the memory channel and DIMM configuration.

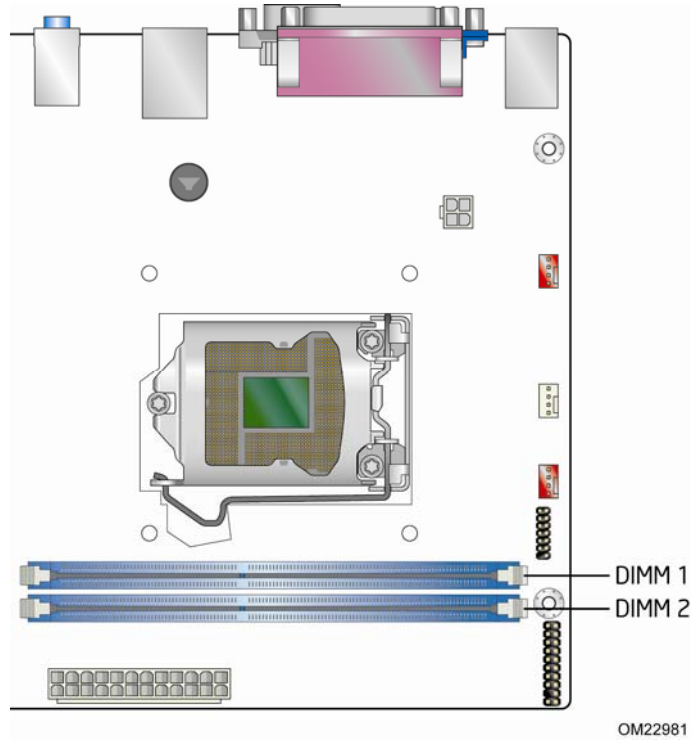

Figure 3. Memory Channel and DIMM Configuration

1.7 Graphics Subsystem

The board supports system graphics through either Intel Graphics Technology or a PCI Express 2.0 x16 add-in graphics card.

1.7.1 Integrated Graphics

The board supports integrated graphics through the Intel® Flexible Display Interface (Intel® FDI) for processors with Intel Graphics Technology.



NOTE

The board will support up to two integrated graphics interfaces plus one PCI Express Graphics card simultaneously with required changes to the BIOS setup.

1.7.1.1 Analog Display (VGA)

The VGA port supports analog displays. The maximum supported resolution is 2048 x 1536 (QXGA) at a 75 Hz refresh rate. The VGA port is enabled for POST whenever a monitor is attached, regardless of the DVI-D connector status.

1.7.1.2 Digital Visual Interface (DVI-D)

The DVI-D port supports only digital DVI displays. The maximum supported resolution is 2048 x 1536 at 75 Hz refresh (QXGA). The DVI-D port is compliant with the DVI 1.0 specification.

1.7.2 PCI Express x16 Graphics

The Intel Core i7, Intel Core i5, Intel Core i3, and Intel Pentium processors in an LGA1155 socket support discrete add in graphics cards through the PCI Express 2.0 x16 graphics connector:

- Supports PCI Express GEN2 frequency of 2.5 GHz resulting in 5.0 Gb/s each direction (500 MB/s) per lane. Maximum theoretical bandwidth on interface is 8 GB/s in each direction, simultaneously, when operating in x16 mode.
- Supports PCI Express GEN1 frequency of 1.25 GHz resulting in 2.5 Gb/s each direction (250 MB/s) per lane. Maximum theoretical bandwidth on interface is 4 GB/s in each direction, simultaneously, when operating in x16 mode.

For information about

PCI Express technology

Refer to

<http://www.pcisig.com>

1.8 USB

The board supports up to ten USB 2.0 ports. The port arrangement is as follows:

- Four USB 2.0 ports are implemented with stacked back panel connectors (black)
- Six USB 2.0 front panel ports are implemented through three dual-port internal headers

All 10 USB ports are high-speed, full-speed, and low-speed capable.



NOTE

Computer systems that have an unshielded cable attached to a USB port may not meet FCC Class B requirements, even if no device is attached to the cable. Use a shielded cable that meets the requirements for full-speed devices.

For information about

The location of the USB connectors on the back panel

The location of the front panel USB headers

Refer to

Figure 9, page 42

Figure 10, page 43

1.9 SATA Interfaces

The board provides four 3 Gb/s SATA connectors, which support one device per connector.

The underlying SATA functionality is transparent to the operating system. The SATA controller can operate in both legacy and native modes. In legacy mode, standard IDE I/O and IRQ resources are assigned (IRQ 14 and 15). In Native mode, standard PCI Conventional bus resource steering is used. Native mode is the preferred mode for configurations using the Windows* XP, Windows Vista*, and Windows 7* operating systems.

For more information, see: <http://www.serialata.org/>.

For information about

The location of the SATA connectors

Refer to

Figure 10, page 43

1.10 Legacy I/O Controller

The Legacy I/O Controller provides the following features:

- One serial port
- One back panel parallel port (with Extended Capabilities Port (ECP) and Enhanced Parallel Port (EPP) support)
- PS/2-style keyboard/mouse interface on the back panel
- Serial IRQ interface compatible with serialized IRQ support for PCI Conventional bus systems
- Intelligent power management, including a programmable wake-up event interface
- Conventional PCI bus power management support

The BIOS Setup program provides configuration options for the Legacy I/O controller.

1.10.1 Serial Port

The serial port is implemented as a 10-pin header on the board. The serial port supports data transfers at speeds up to 115.2 kbits/s with BIOS support.

For information about	Refer to
------------------------------	-----------------

The location of the serial port header	Figure 10, page 43
--	--------------------

1.11 Audio Subsystem

The board supports Intel High Definition Audio through the Realtek ALC892 audio codec interface.

The Realtek ALC892-based audio subsystem supports the following features:

- 6+2-channel audio with independent multi-streaming stereo.
- Advanced jack sense for the back panel audio jacks that enables the audio codec to recognize the device that is connected to an audio port. The back panel audio jacks are capable of retasking according to the user's definition, or can be automatically switched depending on the recognized device type.
- Stereo input and output through back panel jacks
- Headphone and Mic in functions for front panel audio jacks
- S/PDIF audio header
- A signal-to-noise (S/N) ratio of 90 dB

Table 4 lists the supported functions of the front panel and back panel audio jacks.

Table 4. Audio Jack Support

Audio Jack	Micro- phone	Head- phones	Line Out (Front Speakers)	Line In (Surround)	Mic In (Center/Sub)
FP Green		Default			
FP Pink	Default				
Rear Blue				Default	
Rear Green		Ctrl panel	Default		
Rear Pink					Default

1.11.1 Audio Subsystem Software

Audio software and drivers are available from Intel's World Wide Web site.

For information about	Refer to
Obtaining audio software and drivers	Section 1.3, page 16

1.11.2 Audio Headers and Connectors

The board contains audio connectors and headers on both the back panel and the component side of the board. The component-side audio headers include the following:

- Front panel audio (a 2 x 5-pin header that provides headphone and mic in signals for front panel audio connectors) (yellow)
- S/PDIF audio header (1 x 4-pin header) (yellow)
- Internal mono speaker header (1 x 2-pin header) (yellow)

For information about	Refer to
The locations of the front panel audio header, S/PDIF header, and internal mono speaker header	Figure 10, page 43
The signal names of the front panel audio header	Table 15 and Table 16, page 46
The signal names of the S/PDIF header	Table 13, page 45
The signal names of the internal mono speaker header	Table 14, page 45
The back panel audio connectors	Section 2.2.1, page 42

1.11.2.1 Analog Audio Connectors

The available configurable back panel audio connectors are shown in Figure 4.

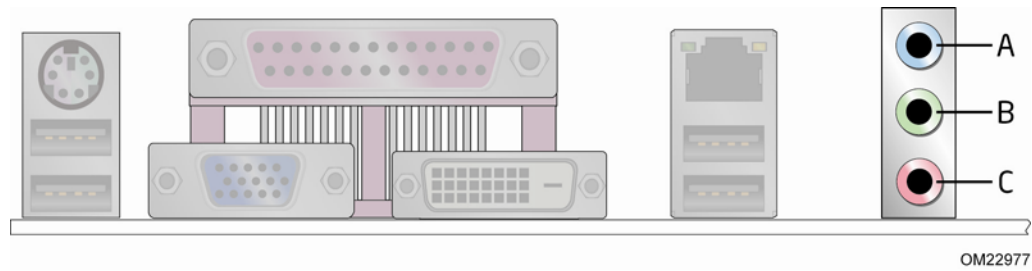

Item	Description
A	Line in
B	Line out/front speakers
C	Mic in/side surround

Figure 4. Back Panel Audio Connector Options

The back panel audio connectors are configurable through the audio device drivers.

For information about

The back panel audio connectors

Refer to

Section 2.2.1, page 42

The front panel headphone output is supported using a separate audio channel pair allowing multi-streaming audio configurations such as simultaneous 5.1 surround playback and stereo audio conferencing (through back panel speakers and a front panel headset, respectively).

1.11.2.2 S/PDIF Header

The S/PDIF header allows connections to coaxial or optical dongles for digital audio output.

1.11.2.3 Internal Mono Speaker Header

The internal mono speaker header allows connection to an internal, low-power speaker for basic system sound capability. The subsystem is capable of driving a speaker load of 8 Ohms at 1 W (rms) or 4 Ohms at 1.5 W (rms).

1.12 LAN Subsystem

The LAN subsystem consists of the following:

- Intel 82579V Gigabit Ethernet Controller (10/100/1000 Mbps/s)
- Intel H61 Express Chipset
- RJ-45 LAN connector with integrated status LEDs

Additional features of the LAN subsystem include:

- CSMA/CD protocol engine
- LAN connect interface between the PCH and the LAN controller
- PCI Conventional bus power management
 - ACPI technology support
 - LAN wake capabilities
- LAN subsystem software

For information about	Refer to
LAN software and drivers	http://downloadcenter.intel.com

1.12.1 Intel® 82579V Gigabit Ethernet Controller

The Intel 82579V Gigabit Ethernet Controller supports the following features:

- 10/100/1000 BASE-T IEEE 802.3 compliant
- Energy Efficient Ethernet (EEE) IEEE802.3az support [Low Power Idle (LPI) mode]
- Dual interconnect between the Integrated LAN Controller and the Physical Layer (PHY):
 - PCI Express-based interface for active state operation (S0) state
 - SMBUS for host and management traffic (Sx low power state)
- Compliant to IEEE 802.3x flow control support
- 802.1p and 802.1q
- TCP, IP, and UDP checksum offload (for IPv4 and IPv6)
- Full device driver compatibility

1.12.2 LAN Subsystem Software

LAN software and drivers are available from Intel's World Wide Web site.

For information about	Refer to
Obtaining LAN software and drivers	Section 1.3, page 16

1.12.3 RJ-45 LAN Connector with Integrated LEDs

Two LEDs are built into the RJ-45 LAN connector (shown in Figure 5).

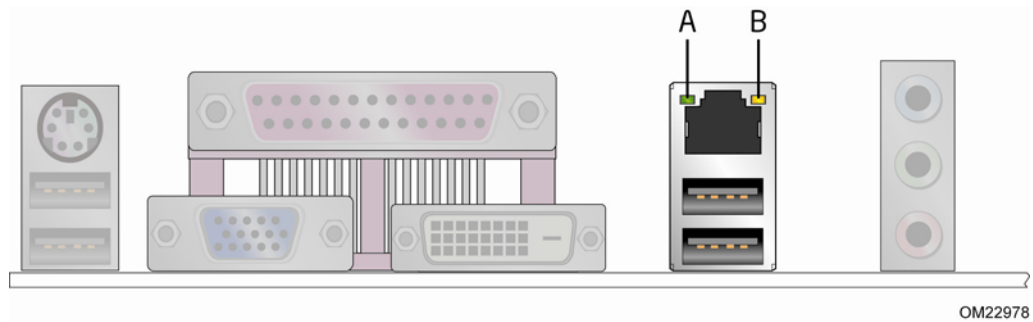

Item	Description
A	Link/Activity LED (green)
B	Link Speed LED (green/yellow)

Figure 5. LAN Connector LED Locations

Table 5 describes the LED states when the board is powered up and the LAN subsystem is operating.

Table 5. LAN Connector LED States

LED	LED Color	LED State	Condition
Link/Activity	Green	Off	LAN link is not established.
		On	LAN link is established.
		Blinking	LAN activity is occurring.
Link Speed	Green/Yellow	Off	10 Mbits/s data rate is selected or negotiated.
		Green	100 Mbits/s data rate is selected or negotiated.
		Yellow	1000 Mbits/s data rate is selected or negotiated.

1.13 Real-Time Clock Subsystem

A coin-cell battery (CR2032) powers the real-time clock and CMOS memory. When the computer is not plugged into a wall socket, the battery has an estimated life of three years. When the computer is plugged in, the standby current from the power supply extends the life of the battery.

The clock is accurate to ± 13 minutes/year at 25 °C with power applied through the power supply 5V STBY rail.



NOTE

If the battery and AC power fail, date and time values will be reset and the user will be notified during POST.

When the voltage drops below a certain level, the BIOS Setup program settings stored in CMOS RAM (for example, the date and time) might not be accurate. Replace the battery with an equivalent one. Figure 1 on page 13 shows the location of the battery.

1.14 Thermal Monitoring

Figure 6 shows the locations of the thermal sensors and fan headers.

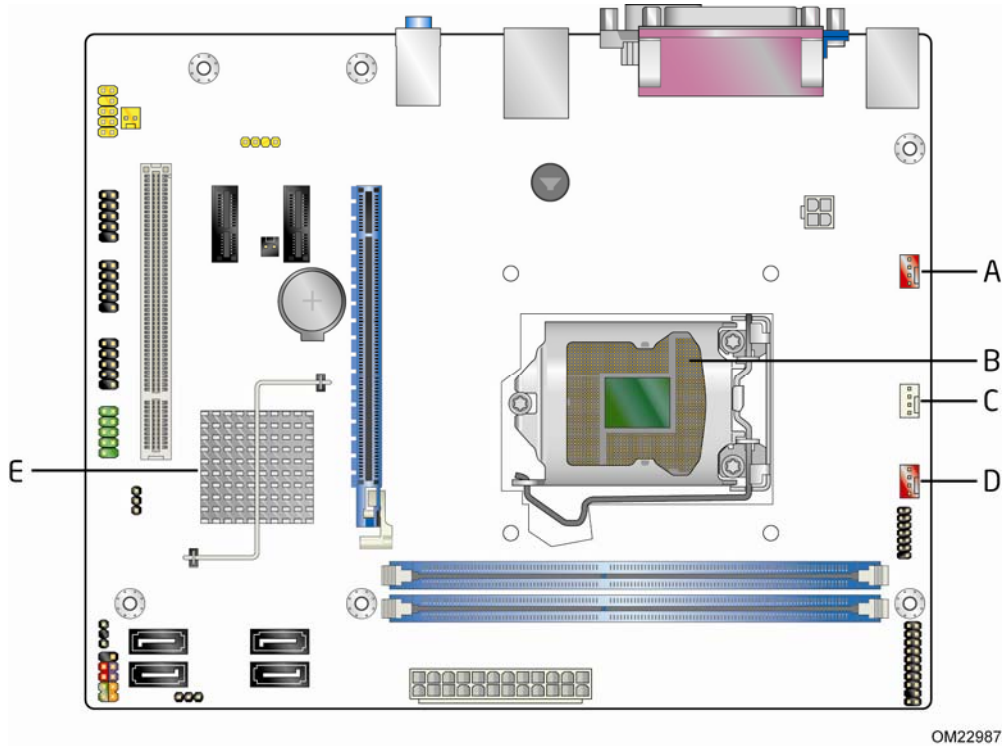

Item	Description
A	Rear chassis fan header
B	Thermal diode, located on processor die
C	Processor fan header
D	Front chassis fan header
E	Thermal diode, located on the Intel H61 PCH

Figure 6. Thermal Sensors and Fan Headers

1.15 Platform Management and Security

Intel DH61CR Desktop Board integrates several functions designed to manage the system and lower the total cost of ownership (TCO) of the system. These system management functions are designed to report errors, diagnose the system, and recover from system lockups without the aid of an external microcontroller.

1.15.1 Hardware Management Subsystem

The hardware management features enable the board to be compatible with the Wired for Management (WfM) specification. The board has several hardware management features, including the following:

- Fan monitoring and control
- Thermal and voltage monitoring
- Chassis intrusion detection

1.15.2 Hardware Monitoring

The hardware monitoring and fan control subsystem is based on the Nuvoton W83677HG-i device, which supports the following:

- Processor and system ambient temperature monitoring
- Chassis fan speed monitoring
- Power monitoring of +12 V, +5 V, +3.3 V, V_{SM}, and +VCCP
- SMBus interface

1.15.2.1 Fan Monitoring

Fan monitoring can be observed through the BIOS setup user interface, Intel® Desktop Utilities or third-party software.

For information about	Refer to
------------------------------	-----------------

The functions of the fan headers	Section 1.16.2.2, page 35
----------------------------------	---------------------------

1.15.2.2 Chassis Intrusion and Detection

The board supports a chassis security feature that detects if the chassis cover is removed. The security feature uses a mechanical switch on the chassis that attaches to the chassis intrusion header. When the chassis cover is removed, the mechanical switch is in the closed position.

For information about	Refer to
------------------------------	-----------------

The location of the chassis intrusion header	Figure 10, page 43
--	--------------------

1.16 Power Management

Power management is implemented at several levels, including:

- Software support through Advanced Configuration and Power Interface (ACPI)
- Hardware support:
 - Power connector
 - Fan headers
 - LAN wake capabilities
 - Instantly Available PC technology
 - Wake from USB
 - Power Management Event signal (PME#) wake-up support
 - PCI Express WAKE# signal support
 - Wake from serial port
 - Wake from PS/2

1.16.1 ACPI

ACPI gives the operating system direct control over the power management and Plug and Play functions of a computer. The use of ACPI with this board requires an operating system that provides full ACPI support. ACPI features include:

- Plug and Play (including bus and device enumeration)
- Power management control of individual devices, add-in boards (some add-in boards may require an ACPI-aware driver), video displays, and hard disk drives
- Methods for achieving less than 15-watt system operation in the power-on/standby sleeping state
- A Soft-off feature that enables the operating system to power-off the computer
- Support for multiple wake-up events (see Table 8 on page 33)
- Support for a front panel power and sleep mode switch

Table 6 lists the system states based on how long the power switch is pressed, depending on how ACPI is configured with an ACPI-aware operating system.

Table 6. Effects of Pressing the Power Switch

If the system is in this state...	...and the power switch is pressed for	...the system enters this state
Off (ACPI G2/G5 – Soft off)	Less than four seconds	Power-on (ACPI G0 – working state)
On (ACPI G0 – working state)	Less than four seconds	Soft-off/Standby (note) (ACPI G1 – sleeping state)
On (ACPI G0 – working state)	More than six seconds	Fail safe power-off (ACPI G2/G5 – Soft off)
Sleep (ACPI G1 – sleeping state)	Less than four seconds	Wake-up (ACPI G0 – working state)
Sleep (ACPI G1 – sleeping state)	More than six seconds	Power-off (ACPI G2/G5 – Soft off)

Note: System can only enter Standby state if power switch action is properly configured by the operating system.

1.16.1.1 System States and Power States

Under ACPI, the operating system directs all system and device power state transitions. The operating system puts devices in and out of low-power states based on user preferences and knowledge of how devices are being used by applications. Devices that are not being used can be turned off. The operating system uses information from applications and user settings to put the system as a whole into a low-power state.

Table 7 lists the power states supported by the board along with the associated system power targets. See the ACPI specification for a complete description of the various system and power states.

Table 7. Power States and Targeted System Power

Global States	Sleeping States	Processor States	Device States	Targeted System Power (Note 1)
G0 – working state	S0 – working	C0 – working	D0 – working state.	Full power > 30 W
G1 – sleeping state	S3 – Suspend to RAM. Context saved to RAM.	No power	D3 – no power except for wake-up logic.	Power < 5 W (Note 2)
G1 – sleeping state	S4 – Suspend to disk. Context saved to disk.	No power	D3 – no power except for wake-up logic.	Power < 5 W (Note 2)
G2/S5	S5 – Soft off. Context not saved. Cold boot is required.	No power	D3 – no power except for wake-up logic.	Power < 5 W (Note 2)
G3 – mechanical off AC power is disconnected from the computer.	No power to the system.	No power	D3 – no power for wake-up logic, except when provided by battery or external source.	No power to the system. Service can be performed safely.

Notes:

1. Total system power is dependent on the system configuration, including add-in boards and peripherals powered by the system chassis' power supply.
2. Dependent on the standby power consumption of wake-up devices used in the system.

1.16.1.2 Wake-up Devices and Events

Table 8 lists the devices or specific events that can wake the computer from specific states.

Table 8. Wake-up Devices and Events

These devices/events can wake up the computer...	...from this state
Power switch	S3, S4, S5
RTC alarm	S3, S4, S5
LAN	S3, S4, S5
USB	S3
PME# signal	S3, S4, S5
WAKE# signal	S3, S4, S5
Serial port	S3
PS/2	S3, S4, S5

Notes:

- S4 implies operating system support only.
- USB ports are turned off during S4/S5 states.



NOTE

The use of these wake-up events from an ACPI state requires an operating system that provides full ACPI support. In addition, software, drivers, and peripherals must fully support ACPI wake events.

1.16.2 Hardware Support



CAUTION

Ensure that the power supply provides adequate +5 V standby current if LAN wake capabilities and Instantly Available PC technology features are used. Failure to do so can damage the power supply. The total amount of standby current required depends on the wake devices supported and manufacturing options.

The board provides several power management hardware features, including:

- Power connector
- Fan headers
- LAN wake capabilities
- Instantly Available PC technology
- Wake from USB
- PME# signal wake-up support
- WAKE# signal wake-up support
- Wake from serial port
- Wake from PS/2
- +5 V Standby Power Indicator LED

LAN wake capabilities and Instantly Available PC technology require power from the +5 V standby line.



NOTE

The use of Wake from USB from an ACPI state requires an operating system that provides full ACPI support.

1.16.2.1 Power Connector

ATX12V-compliant power supplies can turn off the system power through system control. When an ACPI-enabled system receives the correct command, the power supply removes all non-standby voltages.

When resuming from an AC power failure, the computer returns to the power state it was in before power was interrupted (on or off). The computer's response can be set using the Last Power State feature in the BIOS Setup program's Boot menu.

For information about	Refer to
The location of the main power connector	Figure 10, page 43
The signal names of the main power connector	Table 22, page 48

1.16.2.2 Fan Headers

The function/operation of the fan headers is as follows:

- The fans are on when the board is in the S0 state
- The fans are off when the board is in the S3, S4, or S5 state
- Each fan header is wired to a fan tachometer input of the hardware monitoring and fan control ASIC
- All fan headers support closed-loop fan control that can adjust the fan speed or switch the fan on or off as needed
- All fan headers have a +12 V DC connection
- 4-pin fan headers are controlled by Pulse Width Modulation
- The front fan and rear fan headers also support linear fan control on 3-wire fans

For information about	Refer to
The location of the fan headers	Figure 10, page 43
The location of the fan headers and sensors for thermal monitoring	Figure 6, page 29

1.16.2.3 LAN Wake Capabilities



CAUTION

For LAN wake capabilities, the +5 V standby line for the power supply must be capable of providing adequate +5 V standby current. Failure to provide adequate standby current when implementing LAN wake capabilities can damage the power supply.

LAN wake capabilities enable remote wake-up of the computer through a network. The LAN subsystem monitors network traffic at the Media Independent Interface. Upon detecting a Magic Packet* frame, the LAN subsystem asserts a wake-up signal that powers up the computer.

1.16.2.4 Instantly Available PC Technology



CAUTION

For Instantly Available PC technology, the +5 V standby line for the power supply must be capable of providing adequate +5 V standby current. Failure to provide adequate standby current when implementing Instantly Available PC technology can damage the power supply.

Instantly Available PC technology enables the board to enter the ACPI S3 (Suspend-to-RAM) sleep-state. While in the S3 sleep-state, the computer will appear to be off (the power supply is off and the front panel power LED will behave as configured by the BIOS "S3 State Indicator" option). When signaled by a wake-up device or event, the system quickly returns to its last known wake state. Table 8 on page 33 lists the devices and events that can wake the computer from the S3 state.

The board supports the *PCI Bus Power Management Interface Specification*. Add-in boards that also support this specification can participate in power management and can be used to wake the computer.

The use of Instantly Available PC technology requires operating system support and PCI 2.2 compliant add-in cards, PCI Express add-in cards, and drivers.

1.16.2.5 Wake from USB

USB bus activity wakes the computer from an ACPI S3 state.



NOTE

Wake from USB requires the use of a USB peripheral that supports Wake from USB and is supported by the operating system.

1.16.2.6 PME# Signal Wake-up Support

When the PME# signal on the Conventional PCI bus is asserted, the computer wakes from an ACPI S3, S4, or S5 state.

1.16.2.7 WAKE# Signal Wake-up Support

When the WAKE# signal on a PCI Express add-in card is asserted, the computer wakes from an ACPI S3, S4, or S5 state.

1.16.2.8 Wake from Serial Port

Serial port activity wakes the computer from an ACPI S3 state.

1.16.2.9 Wake from PS/2 Devices

PS/2 device activity wakes the computer from an ACPI S3, S4, or S5 state. However, when the computer is in an S4 or S5 state, the only PS/2 activity that will wake the computer is the alt-PrtScrn key combination on the keyboard.

1.16.2.10 +5 V Standby Power LED

The green +5 V standby power indicator LED shows that power is still present even when the computer appears to be off. Figure 7 shows the location of the Standby Power indicator LED on the board.



CAUTION

If AC power has been switched off and the standby power indicators are still lit, disconnect the power cord before installing or removing any devices connected to the board. Failure to do so could damage the board and any attached devices.

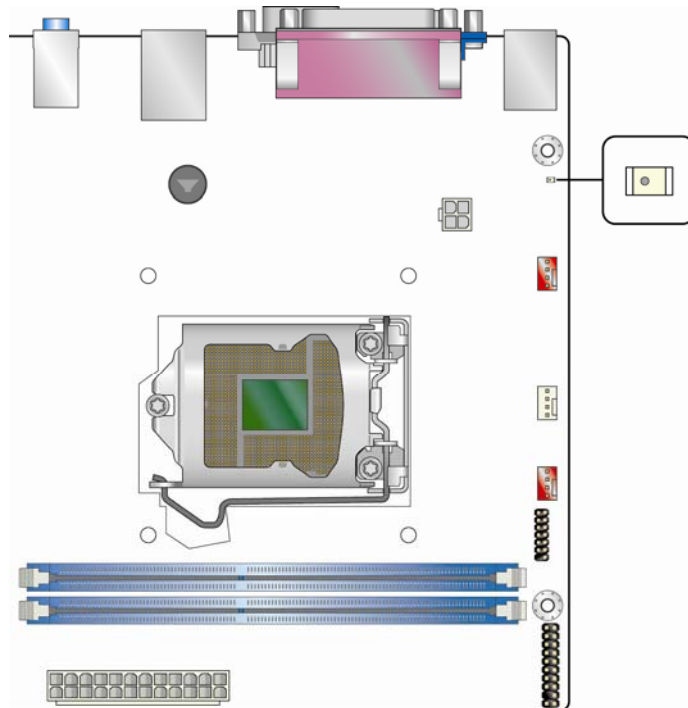

0M22984

Figure 7. Location of the Standby Power LED (Green)

2 Technical Reference

2.1 Memory Resources

2.1.1 Addressable Memory

The board utilizes 8 GB of addressable system memory. Typically the address space that is allocated for Conventional PCI bus add-in cards, PCI Express configuration space, BIOS (SPI Flash device), and chipset overhead resides above the top of DRAM (total system memory). On a system that has 8 GB of system memory installed, it is not possible to use all of the installed memory due to system address space being allocated for other system critical functions. These functions include the following:

- BIOS/SPI Flash device (32 Mbit)
- Local APIC (19 MB)
- Direct Media Interface (40 MB)
- Front side bus interrupts (17 MB)
- PCI Express configuration space (256 MB)
- PCH base address registers PCI Express ports (up to 256 MB)
- Memory-mapped I/O that is dynamically allocated for Conventional PCI and PCI Express add-in cards (256 MB)

The board provides the capability to reclaim the physical memory overlapped by the memory mapped I/O logical address space. The board remaps physical memory from the top of usable DRAM boundary to the 4 GB boundary to an equivalent sized logical address range located just above the 4 GB boundary. Figure 8 shows a schematic of the system memory map. All installed system memory can be used when there is no overlap of system addresses.

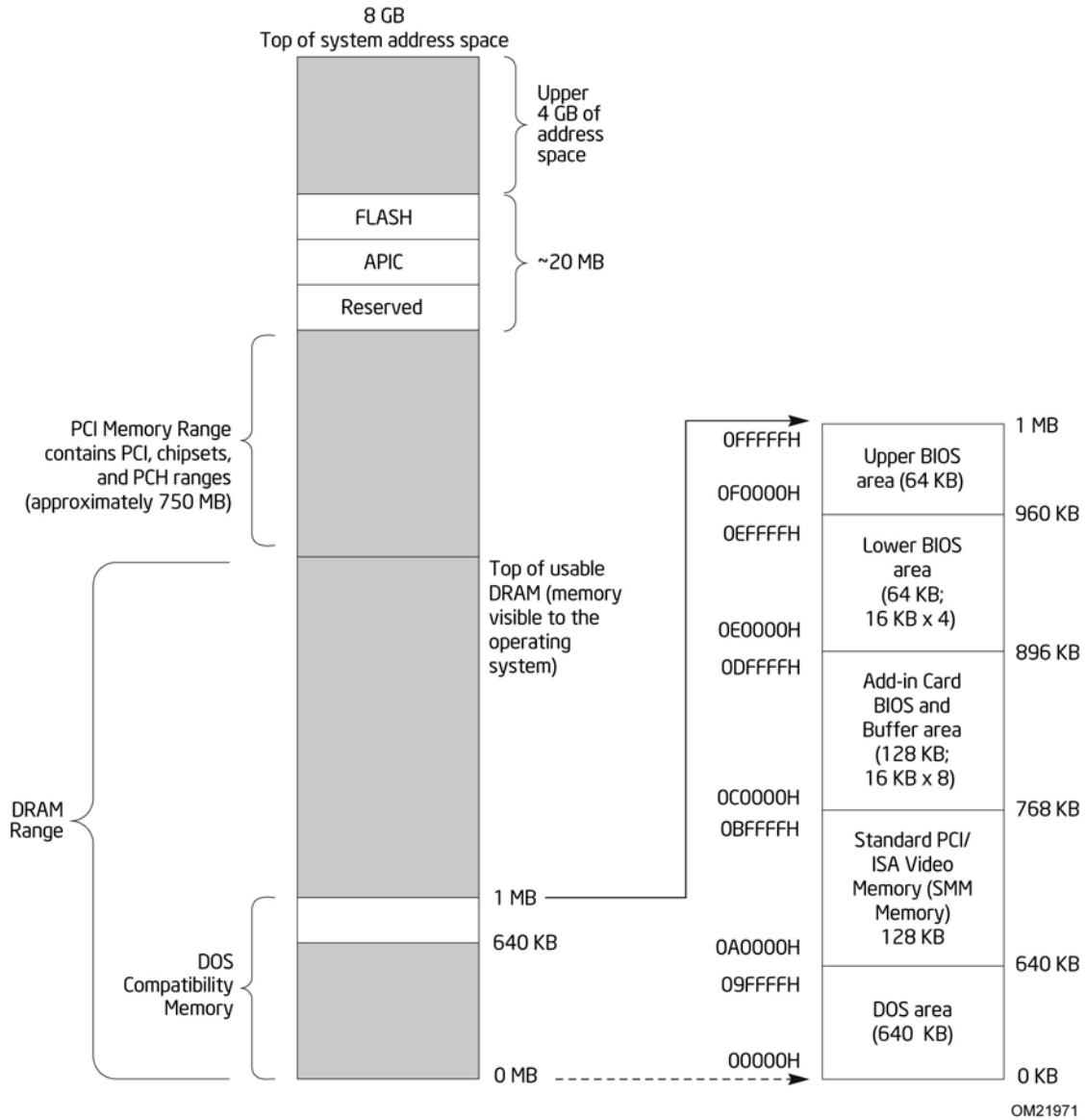

Figure 8. Detailed System Memory Address Map

2.1.2 Memory Map

Table 9 lists the system memory map.

Table 9. System Memory Map

Address Range (decimal)	Address Range (hex)	Size	Description
1024 K - 8388608 K	100000 - 1FFFFFFF	8191 MB	Extended memory
960 K - 1024 K	F0000 - FFFFF	64 KB	Runtime BIOS
896 K - 960 K	E0000 - EFFFF	64 KB	Reserved
800 K - 896 K	C8000 - DFFFF	96 KB	Potential available high DOS memory (open to the PCI bus). Dependent on video adapter used.
640 K - 800 K	A0000 - C7FFF	160 KB	Video memory and BIOS
639 K - 640 K	9FC00 - 9FFFF	1 KB	Extended BIOS data (movable by memory manager software)
512 K - 639 K	80000 - 9FBFF	127 KB	Extended conventional memory
0 K - 512 K	00000 - 7FFFF	512 KB	Conventional memory

2.2 Connectors and Headers



CAUTION

Only the following connectors and headers have overcurrent protection: back panel and front panel USB, and PS/2.

The other internal connectors and headers are not overcurrent protected and should connect only to devices inside the computer's chassis, such as fans and internal peripherals. Do not use these connectors or headers to power devices external to the computer's chassis. A fault in the load presented by the external devices could cause damage to the computer, the power cable, and the external devices themselves.

Furthermore, improper connection of USB header single wire connectors may eventually overload the overcurrent protection and cause damage to the board.

This section describes the board's connectors. The connectors can be divided into these groups:

- Back panel I/O connectors
- Component-side I/O connectors and headers (see page 43)

2.2.1 Back Panel Connectors

Figure 9 shows the location of the back panel connectors for the board.

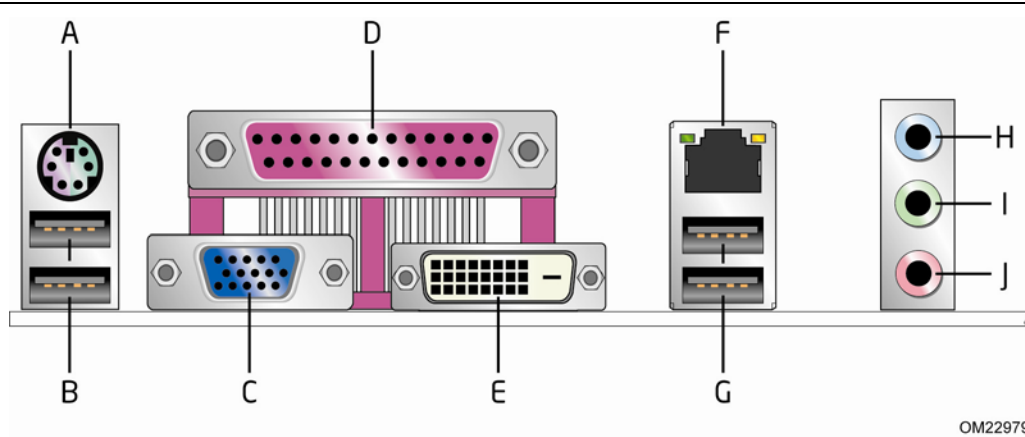

Item	Description
A	PS/2 keyboard/mouse connector
B	USB 2.0 ports
C	VGA connector
D	Parallel port
E	DVI-D connector
F	LAN
G	USB 2.0 ports
H	Line in
I	Line out/front speakers
J	Mic in/side surround

Figure 9. Back Panel Connectors



NOTE

The back panel audio line out connector is designed to power headphones or amplified speakers only. Poor audio quality occurs if passive (non-amplified) speakers are connected to this output.

2.2.2 Component-side Connectors and Headers

Figure 10 shows the locations of the component-side connectors and headers.

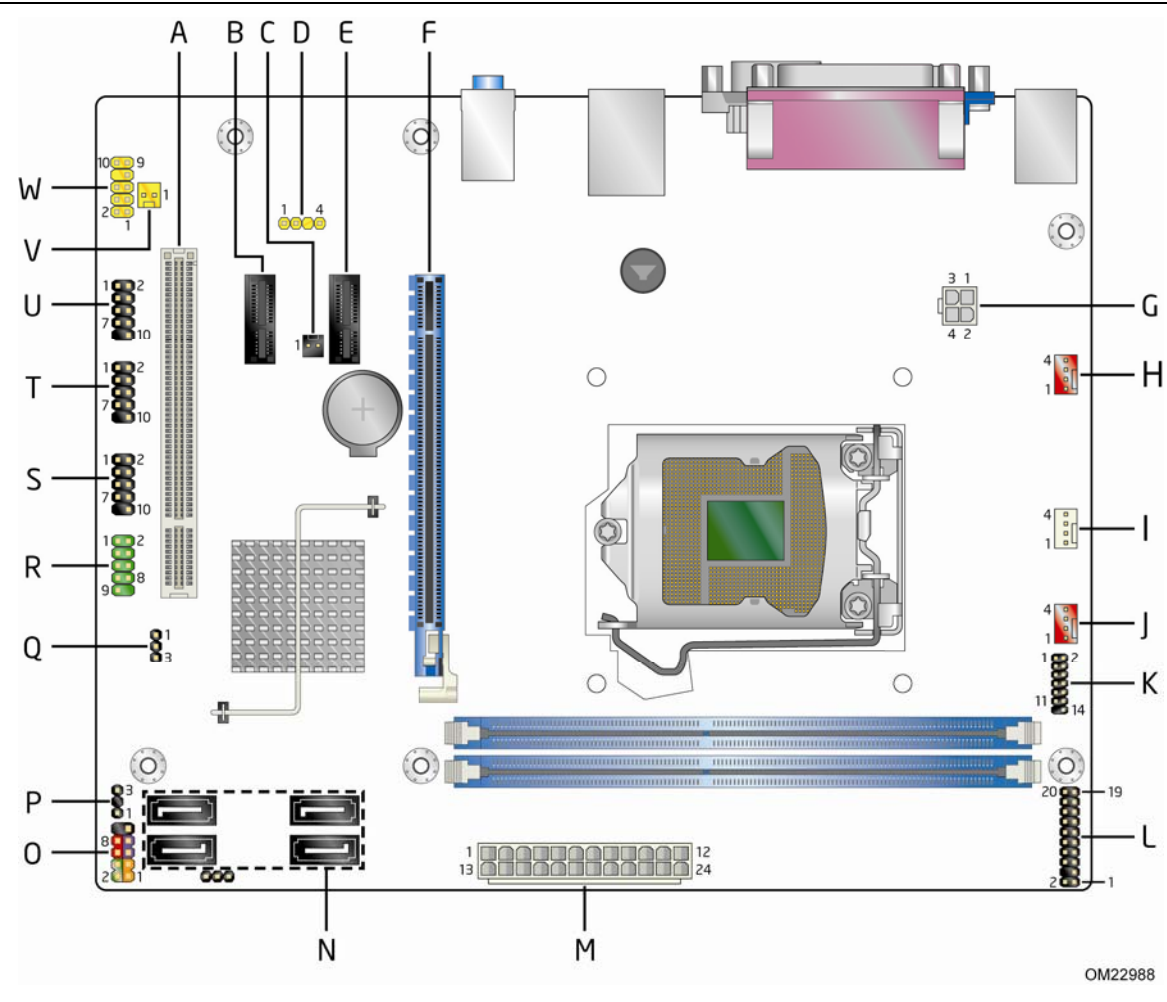

Figure 10. Component-side Connectors and Headers

Table 10 lists the component-side connectors and headers identified in Figure 10.

Table 10. Component-side Connectors and Headers Shown in Figure 10

Item/callout from Figure 10	Description
A	Conventional PCI bus add-in card connector
B	PCI Express x1 add-in card connector
C	Chassis intrusion header
D	S/PDIF header
E	PCI Express x1 add-in card connector
F	PCI Express x16 bus add-in card connector
G	12 V internal power connector (ATX12V)
H	Rear chassis fan header
I	Processor fan header
J	Front chassis fan header
K	LPC Debug header
L	TPM header
M	Main power connector (2 x 12)
N	SATA connectors
O	Front panel header
P	Alternate front panel power LED header
Q	Intel MEBX Reset header
R	Serial port header
S	Front panel USB 2.0 header
T	Front panel USB 2.0 header
U	Front panel USB 2.0 header
V	Internal mono speaker header
W	Front panel audio header

2.2.2.1 Signal Tables for the Connectors and Headers

Table 11. TPM Header

Pin	Signal Name	Pin	Signal Name
1	CK_33M_TPM_DIP	2	Ground
3	LFRAME#	4	Key (no pin)
5	PLTRST#	6	No connection
7	LAD3	8	LAD2
9	+3.3 V	10	LAD1
11	LAD0	12	Ground
13	No connection	14	No connection
15	+3.3 VSB	16	TPM_SERRQ
17	Ground	18	TPM_CLKRUN#
19	LPCPD#	20	No connection

Table 12. Serial Port Header

Pin	Signal Name	Pin	Signal Name
1	DCD (Data Carrier Detect)	2	RXD# (Receive Data)
3	TXD# (Transmit Data)	4	DTR (Data Terminal Ready)
5	Ground	6	DSR (Data Set Ready)
7	RTS (Request To Send)	8	CTS (Clear To Send)
9	RI (Ring Indicator)	10	Key (no pin)

Table 13. S/PDIF Header

Pin	Signal Name
1	Ground
2	S/PDIF out
3	Key (no pin)
3	+5V_DC

Table 14. Internal Mono Speaker Header

Pin	Signal Name
1	-
2	+

Table 15. Front Panel Audio Header for Intel HD Audio

Pin	Signal Name	Pin	Signal Name
1	[Port 1] Left channel	2	Ground
3	[Port 1] Right channel	4	PRESENCE# (Dongle present)
5	[Port 2] Right channel	6	[Port 1] SENSE_RETURN
7	SENSE_SEND (Jack detection)	8	Key (no pin)
9	[Port 2] Left channel	10	[Port 2] SENSE_RETURN

Table 16. Front Panel Audio Header for AC '97 Audio

Pin	Signal Name	Pin	Signal Name
1	MIC	2	AUD_GND
3	MIC_BIAS	4	AUD_GND
5	FP_OUT_R	6	FP_RETURN_R
7	AUD_5V	8	KEY (no pin)
9	FP_OUT_L	10	FP_RETURN_L

**NOTE**

Not all AC '97 signals are supported; specifically, pins 4, 6, 7, and 10 are not supported.

Table 17. Front Panel USB Header

Pin	Signal Name	Pin	Signal Name
1	+5 VDC	2	+5 VDC
3	D-	4	D-
5	D+	6	D+
7	Ground	8	Ground
9	KEY (no pin)	10	No Connect

Table 18. SATA Connectors

Pin	Signal Name
1	Ground
2	TXP
3	TXN
4	Ground
5	RXN
6	RXP
7	Ground

Table 19. Chassis Intrusion Header

Pin	Signal Name
1	Intruder#
2	Ground

Table 20. Fan Headers

Pin	4-Wire Support	Pin	3-Wire Support
1	Ground	3	Ground
2	+12 V	2	FAN_POWER
3	FAN_TACH	1	FAN_TACH
4	FAN_CONTROL	N/A	N/A

2.2.2.2 Add-in Card Connectors

The board has the following add-in card connectors:

- PCI Express 2.0 x16: one PCI Express 2.0 x16 connector. This connector supports simultaneous transfer speeds of up to 8 GB/s of peak bandwidth per direction.
- PCI Express 2.0 x1: two PCI Express 2.0 x1 connectors. The x1 interface supports simultaneous transfer speeds up to 1 GB/s of peak bandwidth per direction and up to 2 GB/s concurrent bandwidth.
- One Conventional PCI (rev 2.3 compliant) connector.

Note the following considerations for the Conventional PCI bus connector:

- The Conventional PCI bus connector is bus master capable.
- SMBus signals are routed to the Conventional PCI bus connector. This enables Conventional PCI bus add-in boards with SMBus support to access sensor data on the desktop board. The specific SMBus signals are as follows:
 - The SMBus clock line is connected to pin A40.
 - The SMBus data line is connected to pin A41.

2.2.2.3 Power Supply Connectors

The board has the following power supply connectors:

- **Main power** – a 2 x 12 connector. This connector is compatible with 2 x 10 connectors previously used on Intel Desktop boards. The board supports the use of ATX12V power supplies with either 2 x 10 or 2 x 12 main power cables. When using a power supply with a 2 x 10 main power cable, pins 11, 12, 23, and 24 must remain unconnected.
- **Processor core power** – a 2 x 2 connector. This connector provides power directly to the processor voltage regulator and must always be used. Failure to do so will prevent the board from booting.



CAUTION

If a high power (75 W or greater) add-in card is installed in the PCI Express x16 connector, that card must also be connected directly to the power supply. Failure to do so may cause damage to the board and the add-in card.

Table 21. Processor Core Power Connector

Pin	Signal Name	Pin	Signal Name
1	Ground	2	Ground
3	+12 V	4	+12 V

Table 22. Main Power Connector

Pin	Signal Name	Pin	Signal Name
1	+3.3 V	13	+3.3 V
2	+3.3 V	14	-12 V
3	Ground	15	Ground
4	+5 V	16	PS-ON# (power supply remote on/off)
5	Ground	17	Ground
6	+5 V	18	Ground
7	Ground	19	Ground
8	PWRGD (Power Good)	20	-5 V (obsolete)
9	+5 V (Standby)	21	+5 V
10	+12 V	22	+5 V
11	+12 V (Note)	23	+5 V (Note)
12	+3.3 V 2 x 12 connector detect (Note)	24	Ground (Note)

Note: When using a 2 x 10 power supply cable, this pin will be unconnected.

For information about

Power supply considerations

Refer to

Section 2.6.1 on page 56

2.2.2.4 Front Panel Header

This section describes the functions of the front panel header. Table 23 lists the signal names of the front panel header. Figure 11 is a connection diagram for the front panel header.

Table 23. Front Panel Header

Pin	Signal	In/Out	Description	Pin	Signal	In/Out	Description
Hard Drive Activity LED				Power LED			
1	HD_PWR	Out	Hard disk LED pull-up to +5 V	2	FP_LED+	Out	Front panel green LED
3	HDA#	Out	Hard disk active LED	4	FP_LED-	Out	Front panel yellow LED
Reset Switch				On/Off Switch			
5	Ground		Ground	6	PWR#	In	Power switch
7	FP_RESET#	In	Reset switch	8	Ground		Ground
Power				Not Connected			
9	+5 V		Power	10	N/C		Not connected

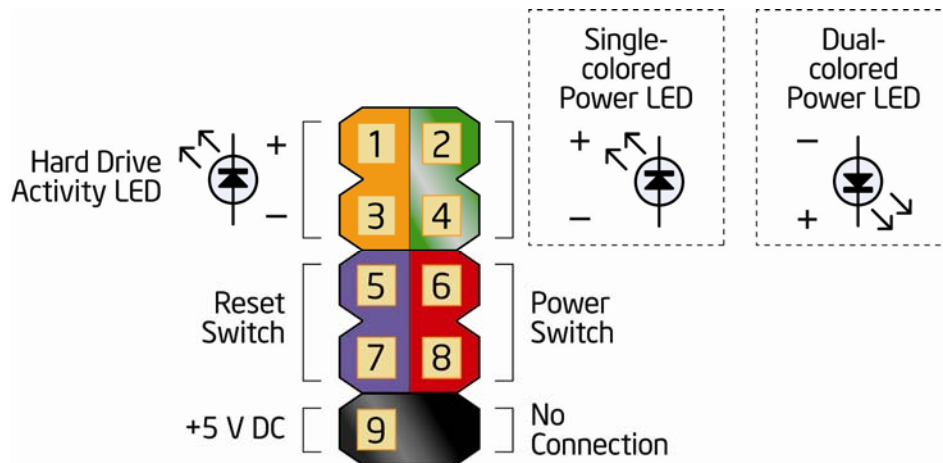

OM20472

Figure 11. Connection Diagram for Front Panel Header

2.2.2.4.1 Hard Drive Activity LED Header

Pins 1 and 3 can be connected to an LED to provide a visual indicator that data is being read from or written to an internal storage device. Proper LED function requires a SATA hard drive or optical drive connected to an onboard SATA connector.

2.2.2.4.2 Reset Switch Header

Pins 5 and 7 can be connected to a momentary single pole, single throw (SPST) type switch that is normally open. When the switch is closed, the board resets and runs the POST.

2.2.2.4.3 Power LED Header

Pins 2 and 4 can be connected to a one- or two-color LED. Table 24 shows the default states for this LED. More options are available through BIOS setup.

Table 24. States for a One-Color Power LED

LED State	Description
Off	Power off/sleeping
Steady Lit	Running
Blink	Standby

2.2.2.4.4 Power Switch Header

Pins 6 and 8 can be connected to a front panel momentary-contact power switch. The switch must pull the SW_ON# pin to ground for at least 50 ms to signal the power supply to switch on or off. (The time requirement is due to internal debounce circuitry on the board.) At least two seconds must pass before the power supply will recognize another on/off signal.

2.2.2.5 Alternate Front Panel Power LED Header

Pins 1 and 3 of this header duplicate the signals on pins 2 and 4 of the front panel header.

Table 25. Alternate Front Panel Power LED Header

Pin	Signal Name	In/Out	Description
1	FP_LED+	Out	FP_LED+
2	Not connected		
3	FP_LED-	Out	FP_LED-

2.2.2.6 Front Panel USB Headers

Figure 12 is a connection diagram for the front panel USB headers.



NOTE

- The +5 V DC power on the USB headers is fused.
- Use only a front panel USB connector that conforms to the USB 2.0 specification for high-speed USB devices.

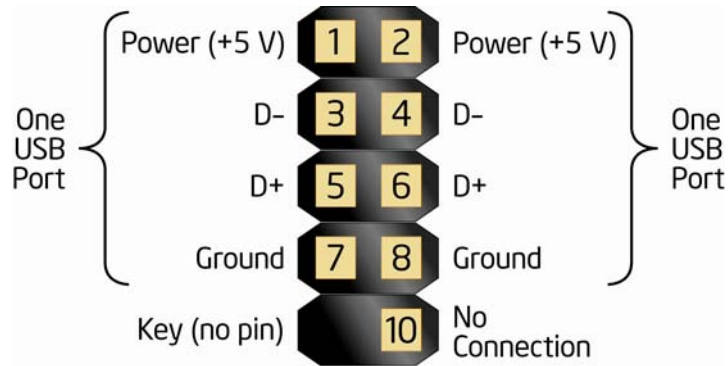

OM20473

Figure 12. Connection Diagram for Front Panel USB Headers

2.2.2.7 Low Pin Count (LPC) Debug Header

During the POST, the BIOS generates diagnostic progress codes (POST codes) to I/O port 80h. If the POST fails, execution stops and the last POST code generated is left at port 80h. This code is useful for determining the point where an error occurred (refer to Section 4.5 on page 69 for a description of the POST codes).

Displaying the POST codes requires a POST card that can interface with the Low Pin Count (LPC) Debug header. The POST card can decode the port and display the contents on a medium such as a seven-segment display.

Table 26. LPC Debug Header

Pin	Signal Name	Pin	Signal Name
1	CK_33M_DEBUG	2	GND
3	PLTRST#	4	LFRAME#
5	LAD0	6	LAD1
7	LAD2	8	LAD3
9	GND	10	GND
11	+3.3 V	12	+3.3 V
13	Not connected	14	+3.3 V

2.3 BIOS Configuration Jumper Block



CAUTION

Do not move the jumper with the power on. Always turn off the power and unplug the power cord from the computer before changing a jumper setting. Otherwise, the board could be damaged.

Figure 13 shows the location of the jumper block. The 3-pin jumper block determines the BIOS Setup program's mode. Table 27 describes the jumper settings for the three modes: normal, configure, and recovery.

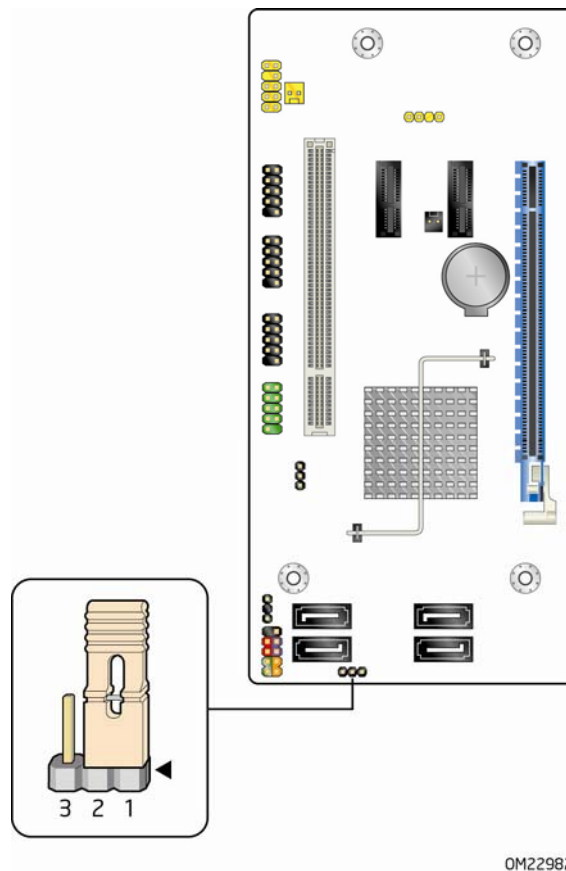

Figure 13. Location of the Jumper Block

Table 27. BIOS Setup Configuration Jumper Settings

Function/Mode	Jumper Setting	Configuration
Normal	1-2	The BIOS uses current configuration information and passwords for booting.
Configure	2-3	<p>After the POST runs, Setup runs automatically. The maintenance menu is displayed.</p> <p>Note that this Configure mode is the only way to clear the BIOS/CMOS settings. Press F9 (restore defaults) while in Configure mode to restore the BIOS/CMOS settings to their default values.</p>
Recovery	None	The BIOS attempts to recover the BIOS configuration. A recovery CD or USB flash drive is required.

2.4 Intel® Management Engine BIOS Extension (Intel® MEBX) Reset Header

The Intel® MEBX reset header (see Figure 14) allows you to reset the Intel AMT configuration to the factory defaults. Momentarily shorting pins 1 and 2 with a jumper (not supplied) will accomplish the following:

- Return all Intel ME parameters to their default values.
- Delete any user entered information, including PID/PPS and user entered Hash Certificates. USB key and remote configuration data will be removed if the parameters are not default parameters.
- Reset the Intel MEBX password to the default value (admin).

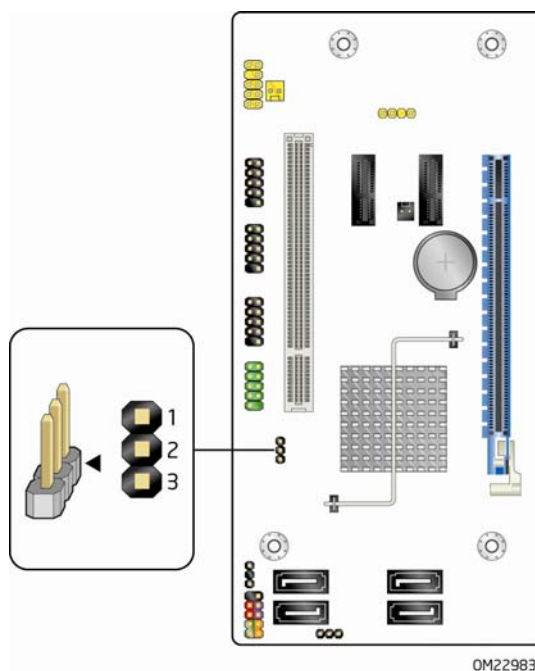

Figure 14. Intel MEBX Reset Header

Table 28. Intel MEBX Reset Header Signals

Pin	Function
1	PCH.AK24 (PCH_RTCRST_PULLUP)
2	Ground
3	No connection



CAUTION

Always turn off the power and unplug the power cord from the computer before installing an MEBX jumper. The jumper must be removed before reapplying power. The system must be allowed to reach end of the POST before reset is complete. Otherwise, the board could be damaged.

2.5 Mechanical Considerations

2.5.1 Form Factor

The board is designed to fit into a microATX form-factor chassis. Figure 15 illustrates the mechanical form factor for the board. Dimensions are given in inches [millimeters]. The outer dimensions are 9.60 inches by 7.80 inches [243.84 millimeters by 198.12 millimeters]. Location of the I/O connectors and mounting holes are in compliance with the ATX specification.

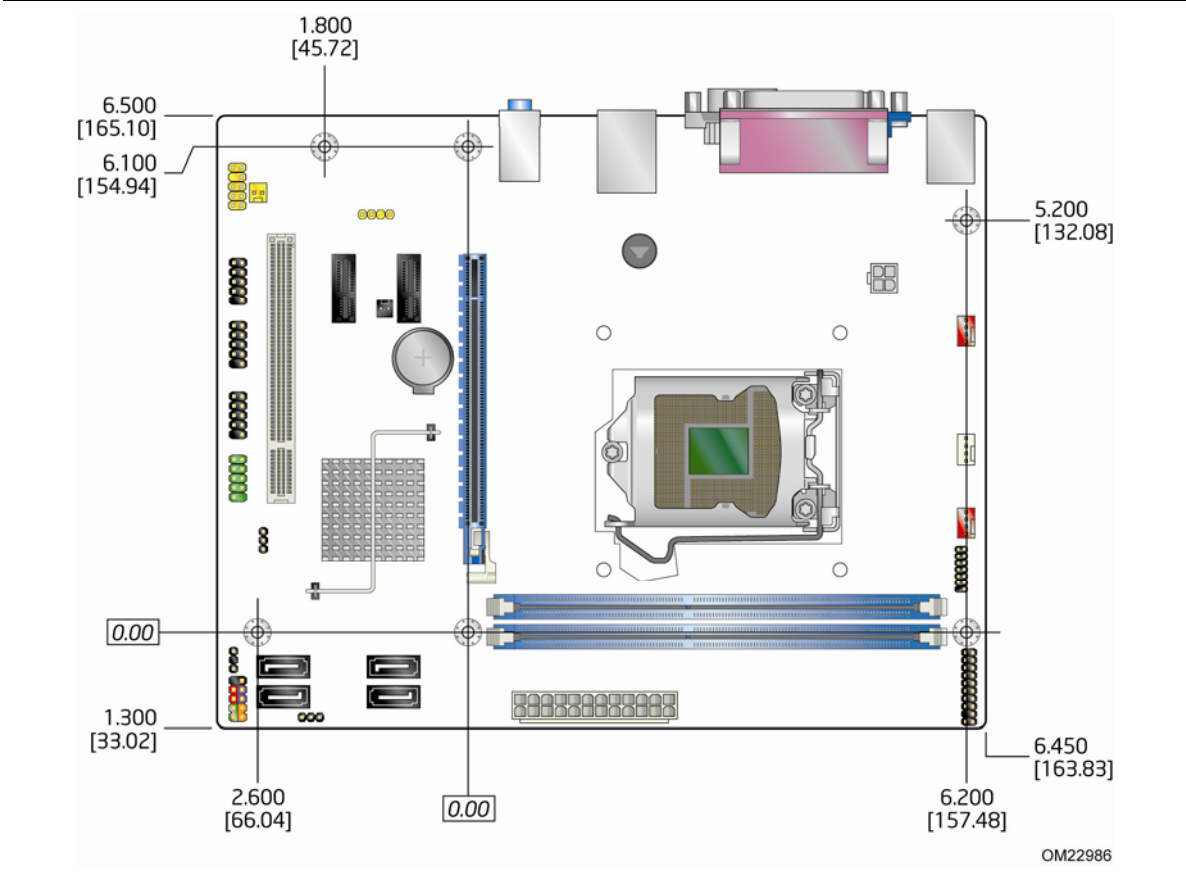

Figure 15. Board Dimensions

2.6 Electrical Considerations

2.6.1 Power Supply Considerations



CAUTION

The +5 V standby line from the power supply must be capable of providing adequate +5 V standby current. Failure to do so can damage the power supply. The total amount of standby current required depends on the wake devices supported and manufacturing options.

Additional power required will depend on configurations chosen by the integrator.

The power supply must comply with the indicated parameters of the ATX form factor specification.

- The potential relation between 3.3 VDC and +5 VDC power rails
- The current capability of the +5 VSB line
- All timing parameters
- All voltage tolerances

For example, for a system consisting of a supported 95 W processor (see Section 1.4 on page 16 for information on supported processors), 2 GB DDR3 RAM, one high end video card, one hard disk drive, one optical drive, and all board peripherals enabled, the minimum recommended power supply is 460 W. Table 29 lists the recommended power supply current values.

Table 29. Recommended Power Supply Current Values

Output Voltage	3.3 V	5 V	12 V1	12 V2	-12 V	5 VSB
Current	22 A	20 A	16 A	16 A	0.3 A	1.5 A

For information about

Selecting an appropriate power supply

Refer to

<http://www.intel.com/support/motherboards/desktop/sb/CS-026472.htm>

2.6.2 Fan Header Current Capability



CAUTION

The processor fan must be connected to the processor fan header, not to a chassis fan header. Connecting the processor fan to a chassis fan header may result in onboard component damage that will halt fan operation.

Table 30 lists the current capability of the fan headers.

Table 30. Fan Header Current Capability

Fan Header	Maximum Available Current
Processor fan	2.0 A
Front chassis fan	1.5 A
Rear chassis fan	1.5 A

2.6.3 Add-in Board Considerations

The board is designed to provide 2 A (average) of current for each add-in board from the +5 V rail. The total +5 V current draw for add-in boards for a fully loaded board (all expansion slots filled) must not exceed the system's power supply +5 V maximum current.

2.7 Thermal Considerations



CAUTION

A chassis with a maximum internal ambient temperature of 38 °C at the processor fan inlet is required. Use of a processor heat sink that provides omni-directional airflow to maintain required airflow across the processor voltage regulator area is highly recommended. For a list of chassis that have been tested with Intel desktop boards please refer to the following website:

http://www3.intel.com/cd/channel/reseller/asmo-na/eng/tech_reference/53211.htm

All responsibility for determining the adequacy of any thermal or system design remains solely with the reader. Intel makes no warranties or representations that merely following the instructions presented in this document will result in a system with adequate thermal performance.



CAUTION

The ambient temperature must not exceed the board's maximum operating temperature. Failure to do so could cause components to exceed their maximum case temperature and malfunction. For information about the maximum operating temperature, see the environmental specifications in Section 2.9.



CAUTION

Ensure that proper airflow is maintained in the processor voltage regulator circuit. Failure to do so may result in damage to the voltage regulator circuit.

Figure 16 shows the locations of the localized high temperature zones.

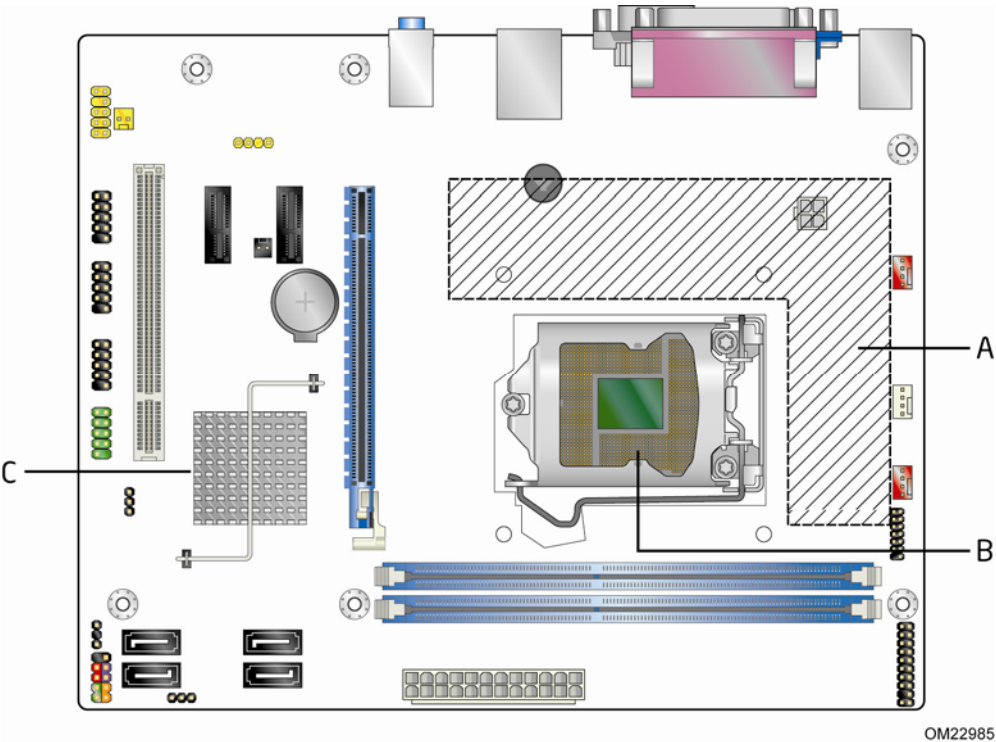

Item	Description
A	Processor voltage regulator area
B	Processor
C	Intel H61 Express Chipset

Figure 16. Localized High Temperature Zones

Table 31 provides maximum case temperatures for the components that are sensitive to thermal changes. The operating temperature, current load, or operating frequency could affect case temperatures. Maximum case temperatures are important when considering proper airflow to cool the board.

Table 31. Thermal Considerations for Components

Component	Maximum Case Temperature
Processor	For processor case temperature, see processor datasheets and processor specification updates
Intel H61 Express Chipset	111 °C (under bias)

For information about	Refer to
Processor datasheets and specification updates	Section 1.3, page 16

2.8 Reliability

The Mean Time Between Failures (MTBF) prediction is calculated using component and subassembly random failure rates. The calculation is based on the Telcordia SR-332, Method I Case 1 50% electrical stress, 55 °C ambient. The MTBF prediction is used to estimate repair rates and spare parts requirements. The MTBF data is calculated from predicted data at 55 °C. The MTBF for the board is 280,583 hours.

2.9 Environmental

Table 32 lists the environmental specifications for the board.

Table 32. Environmental Specifications

Parameter	Specification		
Temperature			
Non-Operating	-40 °C to +60 °C		
Operating	0 °C to +40 °C		
Shock			
Unpackaged	50 g trapezoidal waveform		
	Velocity change of 170 inches/second ²		
Packaged	Half sine 2 millisecond		
	Product Weight (pounds)	Free Fall (inches)	Velocity Change (inches/sec ²)
	<20	36	167
	21-40	30	152
	41-80	24	136
	81-100	18	118
Vibration			
Unpackaged	5 Hz to 20 Hz: 0.01 g ² Hz sloping up to 0.02 g ² Hz		
	20 Hz to 500 Hz: 0.02 g ² Hz (flat)		
Packaged	5 Hz to 40 Hz: 0.015 g ² Hz (flat)		
	40 Hz to 500 Hz: 0.015 g ² Hz sloping down to 0.00015 g ² Hz		

3 Overview of BIOS Features

3.1 Introduction

The board uses an Intel BIOS that is stored in a 32 Mbit (8,192 KB) Serial Peripheral Interface Flash Memory (SPI Flash) device which can be updated using a set of utilities. The SPI Flash contains the BIOS Setup program, POST, LAN EEPROM information, Plug and Play support, and other firmware.

The BIOS displays a message during POST identifying the type of BIOS and a revision code. The initial production BIOSs are identified as BEH6110H.86A.

The BIOS Setup program can be used to view and change the BIOS settings for the computer. The BIOS Setup program is accessed by pressing the <F2> key after the Power-On Self-Test (POST) memory test begins and before the operating system boot begins. The menu bar is shown below.

Maintenance	Main	Configuration	Performance	Security	Power	Boot	Exit
-------------	------	---------------	-------------	----------	-------	------	------



NOTE

The maintenance menu is displayed only when the board is in configure mode. Section 2.3 on page 52 shows how to put the board in configure mode.

Table 33 lists the BIOS Setup program menu features.

Table 33. BIOS Setup Program Menu Bar

Maintenance	Main	Configura- tion	Performance	Security	Power	Boot	Exit
Clears passwords and displays processor information	Displays processor and memory configuration	Configures advanced features available through the chipset	Configures Memory, Bus and Processor overrides	Sets passwords and security features	Configures power management features and power supply controls	Selects boot options	Saves or discards changes to Setup program options

Table 34 lists the function keys available for menu screens.

Table 34. BIOS Setup Program Function Keys

BIOS Setup Program Function Key	Description
<←> or <→>	Selects a different menu screen (Moves the cursor left or right)
<↑> or <↓>	Selects an item (Moves the cursor up or down)
<Tab>	Selects sub-items within a field (i.e., date/time)
<Enter>	Executes command or selects the submenu
<F9>	Load the default configuration values for the current menu
<F10>	Save the current values and exits the BIOS Setup program
<Esc>	Exits the menu

3.2 System Management BIOS (SMBIOS)

SMBIOS is a Desktop Management Interface (DMI) compliant method for managing computers in a managed network.

The main component of SMBIOS is the Management Information Format (MIF) database, which contains information about the computing system and its components. Using SMBIOS, a system administrator can obtain the system types, capabilities, operational status, and installation dates for system components. The MIF database defines the data and provides the method for accessing this information. The BIOS enables applications such as third-party management software to use SMBIOS. The BIOS stores and reports the following SMBIOS information:

- BIOS data, such as the BIOS revision level
- Fixed-system data, such as peripherals, serial numbers, and asset tags
- Resource data, such as memory size, cache size, and processor speed
- Dynamic data, such as event detection and error logging

Non-Plug and Play operating systems require an additional interface for obtaining the SMBIOS information. The BIOS supports an SMBIOS table interface for such operating systems. Using this support, an SMBIOS service-level application running on a non-Plug and Play operating system can obtain the SMBIOS information. Additional board information can be found in the BIOS under the Additional Information header under the Main BIOS page.

3.3 Legacy USB Support

Legacy USB support enables USB devices to be used even when the operating system's USB drivers are not yet available. Legacy USB support is used to access the BIOS Setup program, and to install an operating system that supports USB. By default, Legacy USB support is set to Enabled.

Legacy USB support operates as follows:

1. When you apply power to the computer, legacy support is disabled.
2. POST begins.
3. Legacy USB support is enabled by the BIOS allowing you to use a USB keyboard to enter and configure the BIOS Setup program and the maintenance menu.
4. POST completes.
5. The operating system loads. While the operating system is loading, USB keyboards and mice are recognized and may be used to configure the operating system. (Keyboards and mice are not recognized during this period if Legacy USB support was set to Disabled in the BIOS Setup program.)
6. After the operating system loads the USB drivers, all legacy and non-legacy USB devices are recognized by the operating system, and Legacy USB support from the BIOS is no longer used.

3.4 BIOS Updates

The BIOS can be updated using either of the following utilities, which are available on the Intel World Wide Web site:

- Intel® Express BIOS Update utility, which enables automated updating while in the Windows environment. Using this utility, the BIOS can be updated from a file on a hard disk, a USB drive (a flash drive or a USB drive), or an optical drive.
- Intel® Flash Memory Update Utility, which requires booting from DOS. Using this utility, the BIOS can be updated from a file on a hard disk, a USB drive (a flash drive or a USB drive), or an optical drive.
- Intel® F7 switch allows a user to select where the BIOS .bio file is located and perform the update from that location/device. Similar to performing a BIOS Recovery without removing the BIOS configuration jumper.

Both utilities verify that the updated BIOS matches the target system to prevent accidentally installing an incompatible BIOS.



NOTE

Review the instructions distributed with the upgrade utility before attempting a BIOS update.

For information about	Refer to
------------------------------	-----------------

BIOS update utilities	http://www.intel.com/support/motherboards/desktop/sb/CS-022312.htm
-----------------------	---

3.4.1 Language Support

The BIOS Setup program and help messages are supported in US English.

3.4.2 Custom Splash Screen

During POST, an Intel® splash screen is displayed by default. This splash screen can be augmented with a custom splash screen. The Intel Integrator’s Toolkit that is available from Intel can be used to create a custom splash screen.

For information about	Refer to
Intel® Integrator Toolkit	http://developer.intel.com/design/motherbd/software/itk/
Additional Intel® software tools	http://developer.intel.com/products/motherboard/DH61CR/tools.htm and http://developer.intel.com/design/motherbd/software.htm

3.5 BIOS Recovery

It is unlikely that anything will interrupt a BIOS update; however, if an interruption occurs, the BIOS could be damaged. Table 35 lists the drives and media types that can and cannot be used for BIOS recovery. The BIOS recovery media does not need to be made bootable however, it must contain the motherboard .bio file at the root level.

Table 35. Acceptable Drives/Media Types for BIOS Recovery

Media Type	Can be used for BIOS recovery?
Optical drive connected to the SATA interface	Yes
USB removable drive (a USB Flash Drive, for example)	Yes
USB diskette drive (with a 1.44 MB diskette)	No
USB hard disk drive	No
Legacy diskette drive (with a 1.44 MB diskette) connected to the legacy diskette drive interface	No

For information about	Refer to
BIOS recovery	http://www.intel.com/support/motherboards/desktop/sb/cs-023360.htm

3.6 Boot Options

In the BIOS Setup program, the user can choose to boot from a hard drive, optical drive, removable drive, or the network. The default setting is for the optical drive to be the first boot device, the hard drive second, removable drive third, and the network fourth.

3.6.1 Optical Drive Boot

Booting from the optical drive is supported in compliance to the El Torito bootable CD-ROM format specification. Under the Boot menu in the BIOS Setup program, the optical drive is listed as a boot device. Boot devices are defined in priority order. Accordingly, if there is not a bootable CD in the optical drive, the system will attempt to boot from the next defined drive.

3.6.2 Network Boot

The network can be selected as a boot device. This selection allows booting from the onboard LAN or a network add-in card with a remote boot ROM installed.

Pressing the <F12> key during POST automatically forces booting from the LAN. To use this key during POST, the User Access Level in the BIOS Setup program's Security menu must be set to Full.

3.6.3 Booting Without Attached Devices

For use in embedded applications, the BIOS has been designed so that after passing the POST, the operating system loader is invoked even if the following devices are not present:

- Video adapter
- Keyboard
- Mouse

3.6.4 Changing the Default Boot Device During POST

Pressing the <F10> key during POST causes a boot device menu to be displayed. This menu displays the list of available boot devices. Table 36 lists the boot device menu options.

Table 36. Boot Device Menu Options

Boot Device Menu Function Keys	Description
<↑> or <↓>	Selects a default boot device
<Enter>	Exits the menu, and boots from the selected device
<Esc>	Exits the menu and boots according to the boot priority defined through BIOS setup

4 Error Messages and Beep Codes

4.1 Speaker

The board-mounted piezoelectric speaker provides audible error code (beep code) information during POST.

For information about

The location of the onboard speaker

Refer to

Figure 1, page 13

4.2 BIOS Beep Codes

Whenever a recoverable error occurs during POST, the BIOS causes the board's piezoelectric speaker to beep an error message describing the problem (see Table 37).

Table 37. BIOS Beep Codes

Type	Pattern	Frequency/Comments
F2 Setup/F10 Boot Menu Prompt	One 0.5 second beep when BIOS is ready to accept keyboard input	932 Hz
BIOS update in progress	None	
Video error (no add-in graphics card installed)	On-off (1.0 second each) two times, then 2.5-second pause (off), entire pattern repeats (beeps and pause) once and the BIOS will continue to boot.	932 Hz For processors requiring an add-in graphics card
Memory error	On-off (1.0 second each) three times, then 2.5-second pause (off), entire pattern repeats (beeps and pause) until the system is powered off.	932 Hz
Thermal trip warning	Alternate high and low beeps (1.0 second each) for eight beeps, followed by system shut down.	High beep 2000 Hz Low beep 1500 Hz

4.3 Front-panel Power LED Blink Codes

Whenever a recoverable error occurs during POST, the BIOS causes the board's front panel power LED to blink an error message describing the problem (see Table 38).

Table 38. Front-panel Power LED Blink Codes

Type	Pattern	Note
F2 Setup/F10 Boot Menu Prompt	None	
BIOS update in progress	Off when the update begins, then on for 0.5 seconds, then off for 0.5 seconds. The pattern repeats until the BIOS update is complete.	
Video error (no add-in graphics card installed)	On-off (1.0 second each) two times, then 2.5-second pause (off), entire pattern repeats (blink and pause) until the system is powered off.	For processors requiring an add-in graphics card
Memory error	On-off (1.0 second each) three times, then 2.5-second pause (off), entire pattern repeats (blinks and pause) until the system is powered off.	
Thermal trip warning	Each beep will be accompanied by the following blink pattern: .25 seconds on, .25 seconds off, .25 seconds on, .25 seconds off. This will result in a total of 16 blinks.	

4.4 BIOS Error Messages

Table 39 lists the error messages and provides a brief description of each.

Table 39. BIOS Error Messages

Error Message	Explanation
CMOS Battery Low	The battery may be losing power. Replace the battery soon.
CMOS Checksum Bad	The CMOS checksum is incorrect. CMOS memory may have been corrupted. Run Setup to reset values.
Memory Size Decreased	Memory size has decreased since the last boot. If no memory was removed, then memory may be bad.
No Boot Device Available	System did not find a device to boot.

4.5 Port 80h POST Codes

During the POST, the BIOS generates diagnostic progress codes (POST codes) to I/O port 80h. If the POST fails, execution stops and the last POST code generated is left at port 80h. This code is useful for determining the point where an error occurred.

Displaying the POST codes requires a POST card that can interface with the Low Pin Count (LPC) Debug header. The POST card can decode the port and display the contents on a medium such as a seven-segment display. Refer to the location of the LPC Debug header in Figure 1.

The following tables provide information about the POST codes generated by the BIOS:

- Table 40 lists the Port 80h POST code ranges
- Table 41 lists the Port 80h POST codes themselves
- Table 42 lists the Port 80h POST sequence



NOTE

In the tables listed above, all POST codes and range values are listed in hexadecimal.

Table 40. Port 80h POST Code Ranges

Range	Subsystem
0x00 – 0x05	Entering SX states S0 to S5.
0x10, 0x20, 0x30, 0x40, 0x50	Resuming from SX states. 0x10 – 0x20 – S2, 0x30 – S3, etc.
0x08 – 0x0F	Security (SEC) phase
0x11 – 0x1F	PEI phase pre MRC execution
0x21 – 0x29	MRC memory detection
0x2A – 0x2F	PEI phase post MRC execution
0x31 – 0x35	Recovery
0x36 – 0x3F	Platform DXE driver
0x41 – 0x4F	CPU Initialization (PEI, DXE, SMM)
0x50 – 0x5F	I/O buses: PCI, USB, ATA, etc. 0x5F is an unrecoverable error. Start with PCI.
0x60 – 0x6F	BDS
0x70 – 0x7F	Output devices: All output consoles.
0x80 – 0x8F	For future use
0x90 – 0x9F	Input devices: Keyboard/Mouse.
0xA0 – 0xAF	For future use
0xB0 – 0xBF	Boot Devices: Includes fixed media and removable media. Not that critical since consoles should be up at this point.
0xC0 – 0xCF	For future use
0xD0 – 0xDF	For future use
0xF0 – 0xFF	

Table 41. Port 80h POST Codes

Port 80 Code	Progress Code Enumeration
	ACPI S States
0x00,0x01,0x02,0x03,0x04,0x05	Entering S0, S2, S3, S4, or S5 state
0x10,0x20,0x30,0x40,0x50	Resuming from S2, S3, S4, S5
	Security Phase (SEC)
0x08	Starting BIOS execution after CPU BIST
0x09	SPI prefetching and caching
0x0A	Load BSP microcode
0x0B	Load APs microcodes
0x0C	Platform program baseaddresses
0x0D	Wake Up All APs
0x0E	Initialize NEM
0x0F	Pass entry point of the PEI core
	PEI before MRC
	PEI Platform driver
0x11	Set bootmode, GPIO init
0x12	Early chipset register programming including graphics init
0x13	Basic PCH init, discrete device init (1394, SATA)
0x14	LAN init
0x15	Exit early platform init driver
	PEI SMBUS
0x16	SMBUSriver init
0x17	Entry to SMBUS execute read/write
0x18	Exit SMBUS execute read/write
	PEI CK505 Clock Programming
0x19	Entry to CK505 programming
0x1A	Exit CK505 programming
	PEI Over-Clock Programming
0x1B	Entry to entry to PEI over-clock programming
0x1C	Exit PEI over-clock programming
	Memory
0x21	MRC entry point
0x23	Reading SPD from memory DIMMs
0x24	Detecting presence of memory DIMMs
0x27	Configuring memory
0x28	Testing memory
0x29	Exit MRC driver
	PEI after MRC
0x2A	Start to Program MTRR Settings
0x2B	Done Programming MTRR Settings

continued

Table 41. Port 80h POST Codes (continued)

Port 80 Code	Progress Code Enumeration
	PEIMs/Recovery
0x31	Crisis Recovery has initiated
0x33	Loading recovery capsule
0x34	Start recovery capsule / valid capsule is found
	CPU Initialization
	CPU PEI Phase
0x41	Begin CPU PEI Init
0x42	XMM instruction enabling
0x43	End CPU PEI Init
	CPU PEI SMM Phase
0x44	Begin CPU SMM Init smm relocate bases
0x45	Smm relocate bases for APs
0x46	End CPU SMM Init
	CPU DXE Phase
0x47	CPU DXE Phase begin
0x48	Refresh memory space attributes according to MTRRs
0x49	Load the microcode if needed
0x4A	Initialize strings to HII database
0x4B	Initialize MP support
0x4C	CPU DXE Phase End
	CPU DXE SMM Phase
0x4D	CPU DXE SMM Phase begin
0x4E	Relocate SM bases for all APs
0x4F	CPU DXE SMM Phase end
	I/O Buses
0x50	Enumerating PCI buses
0x51	Allocating resources to PCI bus
0x52	Hot Plug PCI controller initialization
	USB
0x58	Resetting USB bus
0x59	Reserved for USB
	ATA/ATAPI/SATA
0x5A	Resetting PATA/SATA bus and all devices
0x5B	Reserved for ATA

continued

Table 41. Port 80h POST Codes (continued)

Port 80 Code	Progress Code Enumeration
	BDS
0x60	BDS driver entry point initialize
0x61	BDS service routine entry point (can be called multiple times)
0x62	BDS Step2
0x63	BDS Step3
0x64	BDS Step4
0x65	BDS Step5
0x66	BDS Step6
0x67	BDS Step7
0x68	BDS Step8
0x69	BDS Step9
0x6A	BDS Step10
0x6B	BDS Step11
0x6C	BDS Step12
0x6D	BDS Step13
0x6E	BDS Step14
0x6F	BDS return to DXE core (should not get here)
	Keyboard (PS/2 or USB)
0x90	Resetting keyboard
0x91	Disabling the keyboard
0x92	Detecting the presence of the keyboard
0x93	Enabling the keyboard
0x94	Clearing keyboard input buffer
0x95	Instructing keyboard controller to run Self Test (PS/2 only)
	Mouse (PS/2 or USB)
0x98	Resetting mouse
0x99	Detecting mouse
0x9A	Detecting presence of mouse
0x9B	Enabling mouse
	Fixed Media
0xB0	Resetting fixed media
0xB1	Disabling fixed media
0xB2	Detecting presence of a fixed media (IDE hard drive detection, etc.)
0xB3	Enabling/configuring a fixed media

continued

Table 41. Port 80h POST Codes (continued)

Port 80 Code	Progress Code Enumeration
	Removable Media
0xB8	Resetting removable media
0xB9	Disabling removable media
0xBA	Detecting presence of a removable media (IDE, CDROM detection etc.)
0xBB	Enabling/configuring a removable media
	DXE Core
0xE4	Entered DXE phase
	BDS
0xE7	Waiting for user input
0xE8	Checking password
0xE9	Entering BIOS setup
0xEB	Calling Legacy Option ROMs
	Runtime Phase/EFI OS Boot
0xF8	EFI boot service ExitBootServices() has been called
0xF9	EFI runtime service SetVirtualAddressMap() has been called

Table 42. Typical Port 80h POST Sequence

POST Code	Description
21	Initializing a chipset component
22	Reading SPD from memory DIMMs
23	Detecting presence of memory DIMMs
25	Configuring memory
28	Testing memory
34	Loading recovery capsule
E4	Entered DXE phase
12	Starting application processor initialization
13	SMM initialization
50	Enumerating PCI busses
51	Allocating resourced to PCI bus
92	Detecting the presence of the keyboard
90	Resetting keyboard
94	Clearing keyboard input buffer
95	Keyboard Self Test
EB	Calling Video BIOS
58	Resetting USB bus
5A	Resetting PATA/SATA bus and all devices
92	Detecting the presence of the keyboard
90	Resetting keyboard
94	Clearing keyboard input buffer
5A	Resetting PATA/SATA bus and all devices
28	Testing memory
90	Resetting keyboard
94	Clearing keyboard input buffer
E7	Waiting for user input
01	INT 19
00	Ready to boot

5 Regulatory Compliance and Battery Disposal Information

5.1 Regulatory Compliance

This section contains the following regulatory compliance information for Intel Desktop Board DH61CR:

- Safety standards
- European Union Declaration of Conformity statement
- Product Ecology statements
- Electromagnetic Compatibility (EMC) standards
- Product certification markings

5.1.1 Safety Standards

The Intel Desktop Board DH61CR complies with the safety standards stated in Table 43 when correctly installed in a compatible host system.

Table 43. Safety Standards

Standard	Title
CSA/UL 60950-1	Information Technology Equipment – Safety - Part 1: General Requirements (USA and Canada)
EN 60950-1	Information Technology Equipment – Safety - Part 1: General Requirements (European Union)
IEC 60950-1	Information Technology Equipment – Safety - Part 1: General Requirements (International)

5.1.2 European Union Declaration of Conformity Statement

We, Intel Corporation, declare under our sole responsibility that the product Intel® Desktop Board DH61CR is in conformity with all applicable essential requirements necessary for CE marking, following the provisions of the European Council Directive 2004/108/EC (EMC Directive), 2006/95/EC (Low Voltage Directive), and 2002/95/EC (ROHS Directive).

The product is properly CE marked demonstrating this conformity and is for distribution within all member states of the EU with no restrictions.



This product follows the provisions of the European Directives 2004/108/EC, 2006/95/EC, and 2002/95/EC.

Čeština Tento výrobek odpovídá požadavkům evropských směrnic 2004/108/EC, 2006/95/EC a 2002/95/EC.

Dansk Dette produkt er i overensstemmelse med det europæiske direktiv 2004/108/EC, 2006/95/EC & 2002/95/EC.

Dutch Dit product is in navolging van de bepalingen van Europees Directief 2004/108/EC, 2006/95/EC & 2002/95/EC.

Eesti Antud toode vastab Euroopa direktiivides 2004/108/EC, ja 2006/95/EC ja 2002/95/EC kehtestatud nõuetele.

Suomi Tämä tuote noudattaa EU-direktiivin 2004/108/EC, 2006/95/EC & 2002/95/EC määräyksiä.

Français Ce produit est conforme aux exigences de la Directive Européenne 2004/108/EC, 2006/95/EC & 2002/95/EC.

Deutsch Dieses Produkt entspricht den Bestimmungen der Europäischen Richtlinie 2004/108/EC, 2006/95/EC & 2002/95/EC.

Ελληνικά Το παρόν προϊόν ακολουθεί τις διατάξεις των Ευρωπαϊκών Οδηγιών 2004/108/EC, 2006/95/EC και 2002/95/EC.

Magyar E termék megfelel a 2004/108/EC, 2006/95/EC és 2002/95/EC Európai Irányelv előírásainak.

Icelandic Þessi vara stenst reglugerð Evrópska Efnahags Bandalagsins númer 2004/108/EC, 2006/95/EC, & 2002/95/EC.

Italiano Questo prodotto è conforme alla Direttiva Europea 2004/108/EC, 2006/95/EC & 2002/95/EC.

Latviešu Šis produkts atbilst Eiropas Direktīvu 2004/108/EC, 2006/95/EC un 2002/95/EC noteikumiem.

Lietuvių Šis produktas atitinka Europos direktyvų 2004/108/EC, 2006/95/EC, ir 2002/95/EC nuostatas.

Malti Dan il-prodott hu konformi mal-provvedimenti tad-Direttivi Ewropej 2004/108/EC, 2006/95/EC u 2002/95/EC.

Norsk Dette produktet er i henhold til bestemmelsene i det europeiske direktivet 2004/108/EC, 2006/95/EC & 2002/95/EC.

Polski Niniejszy produkt jest zgodny z postanowieniami Dyrektyw Unii Europejskiej 2004/108/EC, 206/95/EC i 2002/95/EC.

Portuguese Este produto cumpre com as normas da Diretiva Europeia 2004/108/EC, 2006/95/EC & 2002/95/EC.

Español Este producto cumple con las normas del Directivo Europeo 2004/108/EC, 2006/95/EC & 2002/95/EC.

Slovensky Tento produkt je v súlade s ustanoveniami európskych direktív 2004/108/EC, 2006/95/EC a 2002/95/EC.

Slovenščina Izdelek je skladen z določbami evropskih direktiv 2004/108/EC, 2006/95/EC in 2002/95/EC.

Svenska Denna produkt har tillverkats i enlighet med EG-direktiv 2004/108/EC, 2006/95/EC & 2002/95/EC.

Türkçe Bu ürün, Avrupa Birliği'nin 2004/108/EC, 2006/95/EC ve 2002/95/EC yönergelerine uyar.

5.1.3 Product Ecology Statements

The following information is provided to address worldwide product ecology concerns and regulations.

5.1.3.1 Disposal Considerations

This product contains the following materials that may be regulated upon disposal: lead solder on the printed wiring board assembly.

5.1.3.2 Recycling Considerations

As part of its commitment to environmental responsibility, Intel has implemented the Intel Product Recycling Program to allow retail consumers of Intel's branded products to return used products to selected locations for proper recycling.

Please consult the http://www.intel.com/intel/other/ehs/product_ecology for the details of this program, including the scope of covered products, available locations, shipping instructions, terms and conditions, etc.

中文

作为其对环境责任之承诺的部分，英特尔已实施 Intel Product Recycling Program（英特尔产品回收计划），以允许英特尔品牌产品的零售消费者将使用过的产品退还至指定地点作恰当的重复使用处理。

请参考http://www.intel.com/intel/other/ehs/product_ecology了解此计划的详情，包括涉及产品之范围、回收地点、运送指导、条款和条件等。

Deutsch

Als Teil von Intels Engagement für den Umweltschutz hat das Unternehmen das Intel Produkt-Recyclingprogramm implementiert, das Einzelhandelskunden von Intel Markenprodukten ermöglicht, gebrauchte Produkte an ausgewählte Standorte für ordnungsgemäßes Recycling zurückzugeben.

Details zu diesem Programm, einschließlich der darin eingeschlossenen Produkte, verfügbaren Standorte, Versandanweisungen, Bedingungen usw., finden Sie auf der http://www.intel.com/intel/other/ehs/product_ecology

Español

Como parte de su compromiso de responsabilidad medioambiental, Intel ha implantado el programa de reciclaje de productos Intel, que permite que los consumidores al detalle de los productos Intel devuelvan los productos usados en los lugares seleccionados para su correspondiente reciclado.

Consulte la http://www.intel.com/intel/other/ehs/product_ecology para ver los detalles del programa, que incluye los productos que abarca, los lugares disponibles, instrucciones de envío, términos y condiciones, etc.

Français

Dans le cadre de son engagement pour la protection de l'environnement, Intel a mis en œuvre le programme Intel Product Recycling Program (Programme de recyclage des produits Intel) pour permettre aux consommateurs de produits Intel de recycler les produits usés en les retournant à des adresses spécifiées.

Visitez la page Web http://www.intel.com/intel/other/ehs/product_ecology pour en savoir plus sur ce programme, à savoir les produits concernés, les adresses disponibles, les instructions d'expédition, les conditions générales, etc.

日本語

インテルでは、環境保護活動の一環として、使い終えたインテルブランド製品を指定の場所へ返送していただき、リサイクルを適切に行えるよう、インテル製品リサイクルプログラムを発足させました。

対象製品、返送先、返送方法、ご利用規約など、このプログラムの詳細情報は、http://www.intel.com/intel/other/ehs/product_ecology (英語)をご覧ください。

Malay

Sebagai sebahagian daripada komitmennya terhadap tanggungjawab persekitaran, Intel telah melaksanakan Program Kitar Semula Produk untuk membenarkan pengguna-pengguna runcit produk jenama Intel memulangkan produk terguna ke lokasi-lokasi terpilih untuk dikitar semula dengan betul.

Sila rujuk http://www.intel.com/intel/other/ehs/product_ecology untuk mendapatkan butir-butir program ini, termasuklah skop produk yang dirangkumi, lokasi-lokasi tersedia, arahan penghantaran, terma & syarat, dsb.

Portuguese

Como parte deste compromisso com o respeito ao ambiente, a Intel implementou o Programa de Reciclagem de Produtos para que os consumidores finais possam enviar produtos Intel usados para locais selecionados, onde esses produtos são reciclados de maneira adequada.

Consulte o site http://www.intel.com/intel/other/ehs/product_ecology (em Inglês) para obter os detalhes sobre este programa, inclusive o escopo dos produtos cobertos, os locais disponíveis, as instruções de envio, os termos e condições, etc.

Russian

В качестве части своих обязательств к окружающей среде, в Intel создана программа утилизации продукции Intel (Product Recycling Program) для предоставления конечным пользователям марок продукции Intel возможности возврата используемой продукции в специализированные пункты для должной утилизации.

Пожалуйста, обратитесь на веб-сайт http://www.intel.com/intel/other/ehs/product_ecology за информацией об этой программе, принимаемых продуктах, местах приема, инструкциях об отправке, положениях и условиях и т.д.

Türkçe

Intel, çevre sorumluluğuna bağlılığının bir parçası olarak, perakende tüketicilerin Intel markalı kullanılmış ürünlerini belirlenmiş merkezlere iade edip uygun şekilde geri dönüştürmesini amaçlayan Intel Ürünleri Geri Dönüşüm Programı'nı uygulamaya koymuştur.

Bu programın ürün kapsamı, ürün iade merkezleri, nakliye talimatları, kayıtlar ve şartlar v.s dahil bütün ayrıntılarını öğrenmek için lütfen http://www.intel.com/intel/other/ehs/product_ecology

Web sayfasına gidin.

5.1.4 EMC Regulations

The Intel Desktop Board DH61CR complies with the EMC regulations stated in Table 44 when correctly installed in a compatible host system.

Table 44. EMC Regulations

Regulation	Title
FCC 47 CFR Part 15, Subpart B	Title 47 of the Code of Federal Regulations, Part 15, Subpart B, Radio Frequency Devices. (USA)
ICES-003	Interference-Causing Equipment Standard, Digital Apparatus. (Canada)
EN55022	Limits and methods of measurement of Radio Interference Characteristics of Information Technology Equipment. (European Union)
EN55024	Information Technology Equipment – Immunity Characteristics Limits and methods of measurement. (European Union)
EN55022	Australian Communications Authority, Standard for Electromagnetic Compatibility. (Australia and New Zealand)
CISPR 22	Limits and methods of measurement of Radio Disturbance Characteristics of Information Technology Equipment. (International)
CISPR 24	Information Technology Equipment – Immunity Characteristics – Limits and Methods of Measurement. (International)
VCCI V-3, V-4	Voluntary Control for Interference by Information Technology Equipment. (Japan)
KN-22, KN-24	Korean Communications Commission – Framework Act on Telecommunications and Radio Waves Act (South Korea)
CNS 13438	Bureau of Standards, Metrology, and Inspection (Taiwan)

FCC Declaration of Conformity

This device complies with Part 15 of the FCC Rules. Operation is subject to the following two conditions: (1) this device may not cause harmful interference, and (2) this device must accept any interference received, including interference that may cause undesired operation.

For questions related to the EMC performance of this product, contact:

Intel Corporation, 5200 N.E. Elam Young Parkway, Hillsboro, OR 97124
1-800-628-8686

This equipment has been tested and found to comply with the limits for a Class B digital device, pursuant to Part 15 of the FCC Rules. These limits are designed to provide reasonable protection against harmful interference in a residential installation. This equipment generates, uses, and can radiate radio frequency energy and, if not installed and used in accordance with the instructions, may cause harmful interference to radio communications. However, there is no guarantee that interference will not occur in a particular installation. If this equipment does cause harmful interference to radio or television reception, which can be determined by turning the equipment off and on, the user is encouraged to try to correct the interference by one or more of the following measures:

- Reorient or relocate the receiving antenna.
- Increase the separation between the equipment and the receiver.
- Connect the equipment to an outlet on a circuit other than the one to which the receiver is connected.
- Consult the dealer or an experienced radio/TV technician for help.

Any changes or modifications to the equipment not expressly approved by Intel Corporation could void the user's authority to operate the equipment.

Tested to comply with FCC standards for home or office use.

Canadian Department of Communications Compliance Statement

This digital apparatus does not exceed the Class B limits for radio noise emissions from digital apparatus set out in the Radio Interference Regulations of the Canadian Department of Communications.

Le présent appareil numérique n'émet pas de bruits radioélectriques dépassant les limites applicables aux appareils numériques de la classe B prescrites dans le Règlement sur le brouillage radioélectrique édicté par le ministère des Communications du Canada.

Japan VCCI Statement

Japan VCCI Statement translation: This is a Class B product based on the standard of the Voluntary Control Council for Interference from Information Technology Equipment (VCCI). If this is used near a radio or television receiver in a domestic environment, it may cause radio interference. Install and use the equipment according to the instruction manual.

この装置は、情報処理装置等電波障害自主規制協議会（VCCI）の基準に基づくクラスB情報技術装置です。この装置は、家庭環境で使用することを目的としていますが、この装置がラジオやテレビジョン受信機に近接して使用されると、受信障害を引き起こすことがあります。
取扱説明書に従って正しい取り扱いをして下さい。

Korea Class B Statement

Korea Class B Statement translation: This equipment is for home use, and has acquired electromagnetic conformity registration, so it can be used not only in residential areas, but also other areas.

이 기기는 가정용(B급) 전자파적합기기로서 주로 가정에서 사용하는 것을 목적으로 하며, 모든 지역에서 사용할 수 있습니다.

5.1.5 ENERGY STAR* 5.0, e-Standby, and ErP Compliance

The US Department of Energy and the US Environmental Protection Agency have continually revised the ENERGY STAR requirements. Intel has worked directly with these two governmental agencies in the definition of new requirements.

Intel Desktop Board DH61CR meets the following program requirements in an adequate system configuration, including appropriate selection of an efficient power supply:









- Energy Star v5.0, category A
- EPEAT*
- Korea e-Standby
- European Union Energy-related Products Directive 2009 (ErP)

For information about	Refer to
ENERGY STAR requirements and recommended configurations	http://www.intel.com/go/energystar
Electronic Product Environmental Assessment Tool (EPEAT)	http://www.epeat.net/
Korea e-Standby Program	http://www.kemco.or.kr/new_eng/pg02/pg02100300.asp
European Union Energy-related Products Directive 2009 (ErP)	http://ec.europa.eu/enterprise/policies/sustainable-business/sustainable-product-policy/ecodesign/index_en.htm

5.1.6 Regulatory Compliance Marks (Board Level)

Intel Desktop Board DH61CR has the regulatory compliance marks shown in Table 45.

Table 45. Regulatory Compliance Marks

Description	Mark
UL joint US/Canada Recognized Component mark. Includes adjacent UL file number for Intel Desktop Boards: E210882.	
FCC Declaration of Conformity logo mark for Class B equipment.	
CE mark. Declaring compliance to the European Union (EU) EMC directive, Low Voltage directive, and RoHS directive.	
Australian Communications Authority (ACA) and New Zealand Radio Spectrum Management (NZ RSM) C-tick mark. Includes adjacent Intel supplier code number, N-232.	
Japan VCCI (Voluntary Control Council for Interference) mark.	
Korea Certification mark. Includes an adjacent KCC (Korean Communications Commission) certification number: KCC-REM-CPU-DH61CR	
Taiwan BSMI (Bureau of Standards, Metrology and Inspections) mark. Includes adjacent Intel company number, D33025.	
Printed wiring board manufacturer's recognition mark. Consists of a unique UL recognized manufacturer's logo, along with a flammability rating (solder side).	V-0
China RoHS/Environmentally Friendly Use Period Logo: This is an example of the symbol used on Intel Desktop Boards and associated collateral. The color of the mark may vary depending upon the application. The Environmental Friendly Usage Period (EFUP) for Intel Desktop Boards has been determined to be 10 years.	

5.2 Battery Disposal Information



CAUTION

Risk of explosion if the battery is replaced with an incorrect type. Batteries should be recycled where possible. Disposal of used batteries must be in accordance with local environmental regulations.



PRÉCAUTION

Risque d'explosion si la pile usagée est remplacée par une pile de type incorrect. Les piles usagées doivent être recyclées dans la mesure du possible. La mise au rebut des piles usagées doit respecter les réglementations locales en vigueur en matière de protection de l'environnement.



FORHOLDSREGEL

Eksplodingsfare, hvis batteriet erstattes med et batteri af en forkert type. Batterier bør om muligt genbruges. Bortskaffelse af brugte batterier bør foregå i overensstemmelse med gældende miljølovgivning.



OBS!

Det kan oppstå eksplosjonsfare hvis batteriet skiftes ut med feil type. Brukte batterier bør kastes i henhold til gjeldende miljølovgivning.



VIKTIGT!

Risk för explosion om batteriet ersätts med felaktig batterityp. Batterier ska kasseras enligt de lokala miljövårdsbestämmelserna.



VARO

Räjähdyksvaara, jos pariston tyyppi on väärä. Paristot on kierrätettävä, jos se on mahdollista. Käytetyt paristot on hävitettävä paikallisten ympäristömääräysten mukaisesti.



VORSICHT

Bei falschem Einsetzen einer neuen Batterie besteht Explosionsgefahr. Die Batterie darf nur durch denselben oder einen entsprechenden, vom Hersteller empfohlenen Batterietyp ersetzt werden. Entsorgen Sie verbrauchte Batterien den Anweisungen des Herstellers entsprechend.



AVVERTIMENTO

Esiste il pericolo di un esplosione se la pila non viene sostituita in modo corretto. Utilizzare solo pile uguali o di tipo equivalente a quelle consigliate dal produttore. Per disfarsi delle pile usate, seguire le istruzioni del produttore.



PRECAUCIÓN

Existe peligro de explosión si la pila no se cambia de forma adecuada. Utilice solamente pilas iguales o del mismo tipo que las recomendadas por el fabricante del equipo. Para deshacerse de las pilas usadas, siga igualmente las instrucciones del fabricante.



WAARSCHUWING

Er bestaat ontploffingsgevaar als de batterij wordt vervangen door een onjuist type batterij. Batterijen moeten zoveel mogelijk worden gerecycled. Houd u bij het weggooien van gebruikte batterijen aan de plaatselijke milieuwetgeving.



ATENÇÃO

Haverá risco de explosão se a bateria for substituída por um tipo de bateria incorreto. As baterias devem ser recicladas nos locais apropriados. A eliminação de baterias usadas deve ser feita de acordo com as regulamentações ambientais da região.



AŠCIAROŽNÁŠĆ

Існуе рызыка выбуху, калі заменены акумулятар неправільнага тыпу. Акумулятары павінны, па магчымасці, перепрацоўвацца. Пазбаўляцца ад старых акумулятараў патрэбна згодна з мясцовым заканадаўствам па экалогіі.



UPOZORNĚNÍ

V případě výměny baterie za nesprávný druh může dojít k výbuchu. Je-li to možné, baterie by měly být recyklovány. Baterie je třeba zlikvidovat v souladu s místními předpisy o životním prostředí.



Προσοχή

Υπάρχει κίνδυνος για έκρηξη σε περίπτωση που η μπαταρία αντικατασταθεί από μία λανθασμένου τύπου. Οι μπαταρίες θα πρέπει να ανακυκλώνονται όταν κάτι τέτοιο είναι δυνατό. Η απόρριψη των χρησιμοποιημένων μπαταριών πρέπει να γίνεται σύμφωνα με τους κατά τόπο περιβαλλοντικούς κανονισμούς.



VIGYÁZAT

Ha a telepet nem a megfelelő típusú telepre cseréli, az felrobbanhat. A telepeket lehetőség szerint újra kell hasznosítani. A használt telepeket a helyi környezetvédelmi előírásoknak megfelelően kell kiselejtezni.



注意

異なる種類の電池を使用すると、爆発の危険があります。リサイクルが可能な地域であれば、電池をリサイクルしてください。使用後の電池を破棄する際には、地域の環境規制に従ってください。



AWAS

Risiko letupan wujud jika bateri digantikan dengan jenis yang tidak betul. Bateri sepatutnya dikitar semula jika boleh. Pelupusan bateri terpakai mestilah mematuhi peraturan alam sekitar tempatan.



OSTRZEŻENIE

Istnieje niebezpieczeństwo wybuchu w przypadku zastosowania niewłaściwego typu baterii. Zużyte baterie należy w miarę możliwości utylizować zgodnie z odpowiednimi przepisami ochrony środowiska.



PRECAUȚIE

Risc de explozie, dacă bateria este înlocuită cu un tip de baterie necorespunzător. Bateriile trebuie reciclate, dacă este posibil. Depozitarea bateriilor uzate trebuie să respecte reglementările locale privind protecția mediului.



ВНИМАНИЕ

При использовании батареи несоответствующего типа существует риск ее взрыва. Батареи должны быть утилизированы по возможности. Утилизация батарей должна проводиться по правилам, соответствующим местным требованиям.



UPOZORNENIE

Ak batériu vymeníte za nesprávny typ, hrozí nebezpečenstvo jej výbuchu. Batérie by sa mali podľa možnosti vždy recyklovať. Likvidácia použitých batérií sa musí vykonávať v súlade s miestnymi predpismi na ochranu životného prostredia.



POZOR

Zamenjava baterije z baterijo drugačnega tipa lahko povzroči eksplozijo. Če je mogoče, baterije reciklirajte. Rabljene baterije zavrzite v skladu z lokalnimi okoljevarstvenimi predpisi.



คำเตือน

ระวังการระเบิดที่เกิดจากเปลี่ยนแบตเตอรี่ผิดประเภท หากเป็นไปได้ ควรนำแบตเตอรี่ไปรีไซเคิล การทิ้งแบตเตอรี่ใช้แล้วต้องเป็นไปตามกฎข้อบังคับด้านสิ่งแวดล้อมของท้องถิ่น.



UYARI

Yanlış türde pil takıldığında patlama riski vardır. Piller mümkün olduğunda geri dönüştürülmelidir. Kullanılmış piller, yerel çevre yasalarına uygun olarak atılmalıdır.



ОСТОРОГА

Використовуйте батареї правильного типу, інакше існуватиме ризик вибуху. Якщо можливо, використані батареї слід утилізувати. Утилізація використаних батарей має бути виконана згідно місцевих норм, що регулюють охорону довкілля.



UPOZORNĚNÍ

V případě výměny baterie za nesprávný druh může dojít k výbuchu. Je-li to možné, baterie by měly být recyklovány. Baterie je třeba zlikvidovat v souladu s místními předpisy o životním prostředí.



ETTEVAATUST

Kui patarei asendatakse uue ebasobivat tüüpi patareiga, võib tekkida plahvatusoht. Tühjad patareid tuleb võimaluse korral viia vastavasse kogumispunkti. Tühjade patareide äraviskamisel tuleb järgida kohalikke keskkonnakaitse alaseid reegleid.



FIGYELMEZTETÉS

Ha az elemet nem a megfelelő típusúra cseréli, felrobbanhat. Az elemeket lehetőség szerint újra kell hasznosítani. A használt elemeket a helyi környezetvédelmi előírásoknak megfelelően kell kiselejtezni.



UZMANĪBU

Pastāv eksplozijas risks, ja baterijas tiek nomainītas ar nepareiza veida baterijām. Ja iespējams, baterijas vajadzētu nodot attiecīgos pieņemšanas punktus. Bateriju izmešanai atkritumos jānotiek saskaņā ar vietējiem vides aizsardzības noteikumiem.



DĒMESIO

Naudojant netinkamo tipo baterijas įrenginys gali sprogti. Kai tik įmanoma, baterijas reikia naudoti pakartotinai. Panaudotas baterijas išmesti būtina pagal vietinius aplinkos apsaugos nuostatus.



ATTENZJONI

Riskju ta' splużjoni jekk il-batterija tinbidel b'tip ta' batterija mhux korrett. Il-batteriji għandhom jiġu riċiklati fejn hu possibbli. Ir-rimi ta' batteriji użati għandu jsir skond ir-regolamenti ambjentali lokali.



OSTRZEŻENIE

Ryzyko wybuchu w przypadku wymiany na baterie niewłaściwego typu. W miarę możliwości baterie należy poddać recyklingowi. Zużytych baterii należy pozbywać się zgodnie z lokalnie obowiązującymi przepisami w zakresie ochrony środowiska.

