

# User's Guide for

# DOSSIER L50



(December 2007)

# **COPYRIGHTS AND TRADEMARKS**

## **Please note**

The material in this manual is subject to change without notice.

## **Trademarks**

Microsoft, Windows, Windows NT, MS-DOS, Windows 95, Windows 98, Windows ME, Windows 2000 Pro, Windows XP Pro and Windows Vista are registered trademarks of Microsoft Corporation. IBM PC, XT, AT and PS/2 are trademarks of International Business Machines Corporation. Pentium and Pentium Pro are registered trademarks of Intel Corporation. AMI BIOS is a registered trademark of American Megatrends. All other trademarks are acknowledged. JAC-UP, Genie, Contender, Dossier, Vig, Viglen, and Envoy are trademarks of Viglen Limited.

## **Copyright and Patents**

This manual and all accompanying software and documentation are copyrighted and all rights reserved. This product, including software and documentation, may not, in whole or in part, be copied, photocopied, translated or reduced to any electronic or machine-readable form, without prior written consent except for copies retained by the purchaser for backup.

© Copyright 2007 Viglen Limited  
All Rights Reserved  
Dossier L50 Manual Version 1.0  
Printed in the United Kingdom

## **Liability**

No warranty or representation, either expressed or implied, is made with respect to this documentation, its quality, performance, merchantability or fitness for a particular purpose. As a result the documentation is licensed as is, and you, the licensee, are assuming the entire risk as to its quality and performance. The vendor reserves the right to revise this operation manual and all accompanying software and documentation and to make changes in the content without obligation to notify any person or organisation of the revision or change.

In no event will the vendor be liable for direct, indirect, special, incidental or consequential damages arising out of the use or inability to use this product or documentation, even if advised of the possibility of such damages. In particular, the vendor shall not have liability for any hardware, software or data stored or used with the product, including the costs of repairing, replacing or recovering such hardware, software or data.

# Table of Contents

<b>Preface</b> .....	<b>v</b>
Notational Conventions.....	vi
<b>Chapter 1 Getting Started</b> .....	<b>1-1</b>
Getting the Computer Running .....	1-2
Unpacking .....	1-2
Connecting to AC Power .....	1-2
Opening the Cover .....	1-4
Turning On and Off the Computer.....	1-4
Taking a Look at the Computer.....	1-6
Right-Side Components .....	1-6
Left-Side Components .....	1-7
Rear Components .....	1-8
Bottom Components.....	1-9
Top-open Components .....	1-10
Where to Go from Here.....	1-12
<b>Chapter 2 Operating Your Computer</b> .....	<b>2-1</b>
Starting and Stopping the Computer .....	2-2
Starting the Computer .....	2-2
Stopping the Computer .....	2-2
Using the Easy Start Buttons.....	2-4
Using the Keyboard.....	2-5
Typewriter Keys.....	2-5
Cursor-Control Keys .....	2-6
Numeric Keypad .....	2-8
Euro Symbol.....	2-8
Windows Keys .....	2-9

Function Keys .....	2-9
Fn Key .....	2-9
Hot Keys .....	2-10
Using the Touchpad .....	2-11
Configuring the Touchpad .....	2-13
Using the DVD Drive.....	2-14
Inserting and Removing a Disc .....	2-15
Using the Video Features .....	2-16
Configuring the Display Modes .....	2-16
Using the Audio Features .....	2-17
Connecting Audio Devices .....	2-18
Using the Communication Features .....	2-19
Using the Modem (Optional) .....	2-19
Using the LAN .....	2-20
Using the Wireless LAN (Optional) .....	2-21

### **Chapter 3 Managing Power .....3-1**

AC Adapter .....	3-2
Battery Pack .....	3-3
Charging the Battery Pack .....	3-3
Initializing the Battery Pack.....	3-4
Checking the Battery Level.....	3-4
Replacing the Battery Pack .....	3-5
Battery Low Signals and Actions.....	3-7
Power Management.....	3-8
Hibernation.....	3-9
Power-Saving Tips .....	3-10

### **Chapter 4 Expanding Your Computer .....4-1**

Connecting an External Monitor.....	4-2
Connecting a USB Device.....	4-3
Using ExpressCards .....	4-4
ExpressCard Type .....	4-4
Inserting and Removing an ExpressCard .....	4-5

	Internal Components Upgrade .....	4-6
<b>Chapter 5</b>	<b>Using BIOS Setup .....</b>	<b>5-1</b>
	When and How to Use BIOS Setup .....	5-2
	When to Use .....	5-2
	Starting BIOS Setup .....	5-2
	Moving Around and Making Selections .....	5-4
	Main Menu .....	5-5
	Advanced Menu .....	5-6
	Boot Menu .....	5-8
	Exit Menu .....	5-10
<b>Chapter 6</b>	<b>Installing Software Drivers.....</b>	<b>6-1</b>
	How to Use the Driver Disc .....	6-2
	Installing Drivers .....	6-2
	P1 Quick Launch Key Utility .....	6-3
<b>Chapter 7</b>	<b>Caring for the Computer .....</b>	<b>7-1</b>
	Protecting the Computer .....	7-2
	Using the Windows Security Center .....	7-2
	Using the Cable Lock .....	7-3
	Taking Care of the Computer .....	7-4
	Location Guidelines .....	7-4
	General Guidelines .....	7-4
	Cleaning Guidelines .....	7-5
	Battery Pack Guidelines .....	7-5
	When Traveling .....	7-6
<b>Chapter 8</b>	<b>Troubleshooting.....</b>	<b>8-1</b>
	Preliminary Checklist .....	8-2
	Solving Common Problems .....	8-3
	Battery Problems .....	8-4
	DVD Drive Problems .....	8-4
	Display Problems .....	8-5
	ExpressCard Problems .....	8-6

Hardware Device Problems.....	8-7
Hard Disk Drive Problems.....	8-7
Keyboard, Mouse, and Touchpad Problems.....	8-7
LAN Problems.....	8-8
WLAN Problems.....	8-8
Modem Problems.....	8-10
Power Management Problems.....	8-10
Software Problems.....	8-11
Sound Problems.....	8-11
Startup Problems.....	8-12
Other Problems.....	8-13
Resetting the Computer.....	8-14

**Appendix A Specifications ..... A-1**

**Appendix B Regulatory Information ..... B-1**

On the Use of the System.....	B-2
Class B Regulations.....	B-2
Safety Notices.....	B-3
On the Use of the RF Device.....	B-6
USA and Canada Safety Requirements and Notices.....	B-6
European Union CE Marking and Compliance Notices ..	B-9
电子信息产品有毒有害物质或元素名称及含量标示...	B-13

**Index ..... I-1**

# Preface

This manual contains information that will help you operate the computer. It is divided into 8 chapters, 2 appendices, and an index.

- Chapter 1, **Getting Started**, takes you through the process of setting up the computer and identifying its external components.
- Chapter 2, **Operating Your Computer**, tells you how to use the computer's components and features.
- Chapter 3, **Managing Power**, provides information on power.
- Chapter 4, **Expanding Your Computer**, provides information on installing and using peripheral devices.
- Chapter 5, **Using BIOS Setup**, describes the BIOS Setup program that configures the computer's BIOS settings.
- Chapter 6, **Installing Software Drivers**, describes how to install the drivers and utilities supplied with the computer.
- Chapter 7, **Caring for the Computer**, gives you tips in care and maintenance.
- Chapter 8, **Troubleshooting**, gives solutions to common problems you may encounter when using the computer.
- Appendix A, **Specifications**, gives a brief specification of the computer.
- Appendix B, **Regulatory Information**, provides regulatory statements and safety notices on your computer.

# Notational Conventions

Throughout this manual, the following conventions are used to distinguish elements of text.

| **NOTE:** identifies additional information that requires special attention.

| **CAUTION:** identifies important information that, if not followed, may result in loss of data or damage to the computer.

Keyboard keys are shown in a bold typeset. For example:

Press the **Enter** key to complete.

When keys are joined by a plus sign (+), press the first key, and, while keeping the first key down, press the remaining keys, finally release all the keys. When necessary, keys are also shown in graphics.

A title, command, setup item, or button that you can see on the screen is shown in boldface. A value or an option that you can select for a setup item is shown in italic. For example:

Select **When I press the power button**, set it to *Shut down*, and then click the **Save changes** button.



# ***Getting Started***

Congratulations on purchasing this computer.

Your computer incorporates desktop computer capabilities into a compact notebook-sized package. It can greatly enhance your productivity either in the office or at home. And, of course, wherever you need it, the computer is ready and easy “to go.”

This chapter first tells you step by step how to get the computer up and running. You will find instructions for these procedures:

- Unpacking
- Connecting to AC power
- Opening the cover
- Turning on the computer
- Turning off the computer

Then, you will find a section briefly introducing the external components of the computer. And the last section navigates you to the information you may need after the computer is ready for use.

# Getting the Computer Running

This section guides you through the procedures for getting the computer ready for operation.

## Unpacking

After unpacking the shipping carton, you should find these standard items:

- Notebook computer
- Accessories:
  - AC adapter
  - AC power cord
  - Driver disc (Optional)

Inspect all the items. If any item is damaged or missing, notify your dealer immediately.

Keep the shipping carton and packing materials in case you need to ship or store the computer in the future.

## Connecting to AC Power

The computer operates either on the external AC power or internal battery power. It is suggested that you use AC power when you start up the computer for the very first time.

**CAUTION:** Use only the AC adapter included with your computer. Using other AC adapters may damage the computer.

1. Make sure that the computer is turned off.
2. Plug the DC cord of the AC adapter to the power connector of the computer (❶).

3. Plug the female end of the AC power cord to the AC adapter and the male end to an electrical outlet (2).

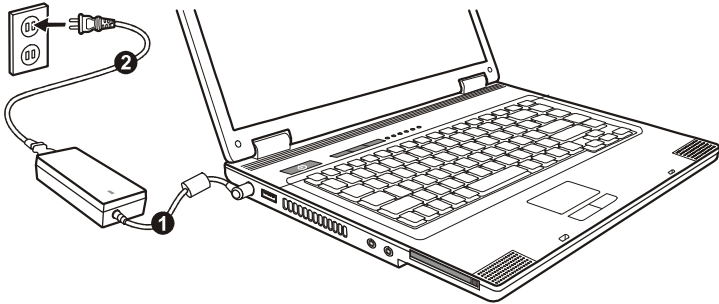

4. When the AC adapter is connected, power is being supplied from the electrical outlet to the AC adapter and onto your computer. Now, you are ready to turn on the computer.

**CAUTION:**

- When you disconnect the AC adapter, disconnect from the electrical outlet first and then from the computer. A reverse procedure may damage the AC adapter or the computer.
- When unplugging the connector, always hold the plug head. Never pull on the cord.

**NOTE:** When the AC adapter is connected, it also charges the battery pack. For information on using battery power, see Chapter 3.

# Opening the Cover

**CAUTION:** Be gentle when opening and closing the cover. Opening it vigorously or slamming it shut could damage the computer.

Open the top cover by sliding the cover latch toward the right (❶) and lifting up the cover (❷). You can tilt the cover forward or backward for optimal viewing clarity.

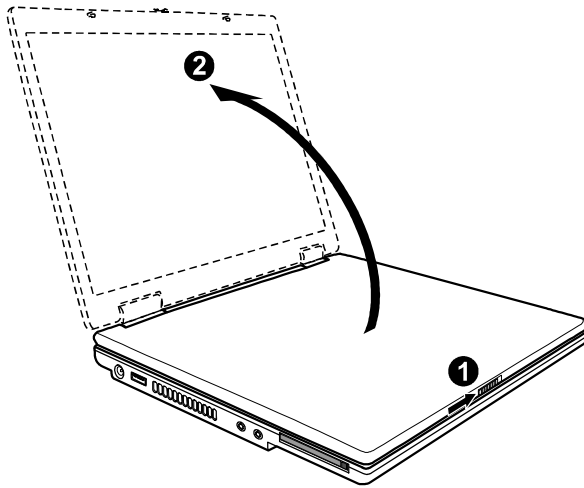

# Turning On and Off the Computer

## Turning On

1. Make sure that the computer is connected to AC power.

2. Press the power button.

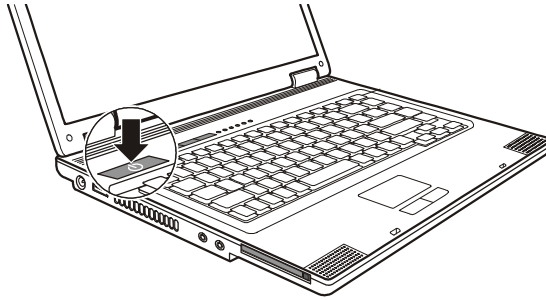

3. Each time the computer is turned on, it performs a Power-On Self Test (POST), and the operating system such as Windows should start.

## Turning Off

To turn off the computer power, use the “Shut Down” command of your operating system.

**NOTE:** There are other ways you can stop the computer so that you will be back to where you left off when you next turn on the computer. (See “Stopping the Computer” in Chapter 2 for information.)

**CAUTION:** If you have to turn the computer on again immediately after turning it off, wait for at least five seconds. Turning the computer off and on rapidly can damage it.

# Taking a Look at the Computer

This section identifies the external components of the computer and briefly describes the function of each component.

**NOTE:** Depending on the model you purchased, the appearance of your computer may not be exactly the same as those shown in this manual.



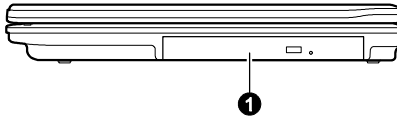

## Right-Side Components

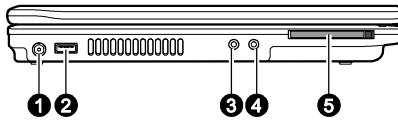

Ref	Component	Description	See Also
①	<b>Combo Drive/ DVD Dual Drive/ Super Multi Drive</b>	Accepts a compact disc for installing or loading software, accessing data, and playing music/video.	P. 2-14





# Left-Side Components

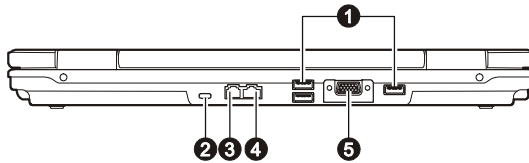

Ref	Component	Description	See Also
1	<b>Power Connector</b> 	Connects the AC adapter.	P. 1-2
2	<b>USB Port</b> 	Connects a USB device, such as a USB flash disk, printer, digital camera, joystick, and more.	P. 4-3
3	<b>Audio Output Connector</b> 	Connects a set of headphones, external speakers with amplifier, or an audio recording device.	P. 2-18
4	<b>Microphone Connector</b> 	Connects an external microphone.	P. 2-18
5	<b>ExpressCard Slot</b> 	Accepts an ExpressCard for additional functions.	P. 4-5

# Rear Components



Ref	Component	Description	See Also
①	USB Ports 	Connect a USB device, such as a USB flash disk, printer, digital camera, joystick, and more.	P. 4-3
②	Kensington Lock 	Locks the computer to a stationery object for security.	P. 7-3
③	RJ-11 Connector 	Connects the telephone line. <b>NOTE:</b> Depending on your model, this connector may not have any function.	P. 2-19
④	RJ-45 Connector 	Connects the LAN cable.	P. 2-20
⑤	VGA Port 	Connects an external monitor.	P. 4-2



# Bottom Components

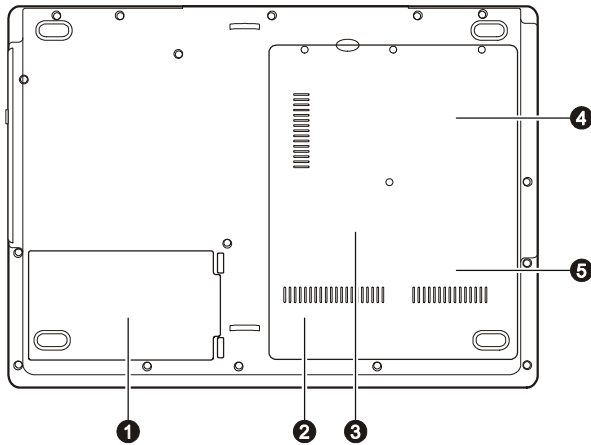





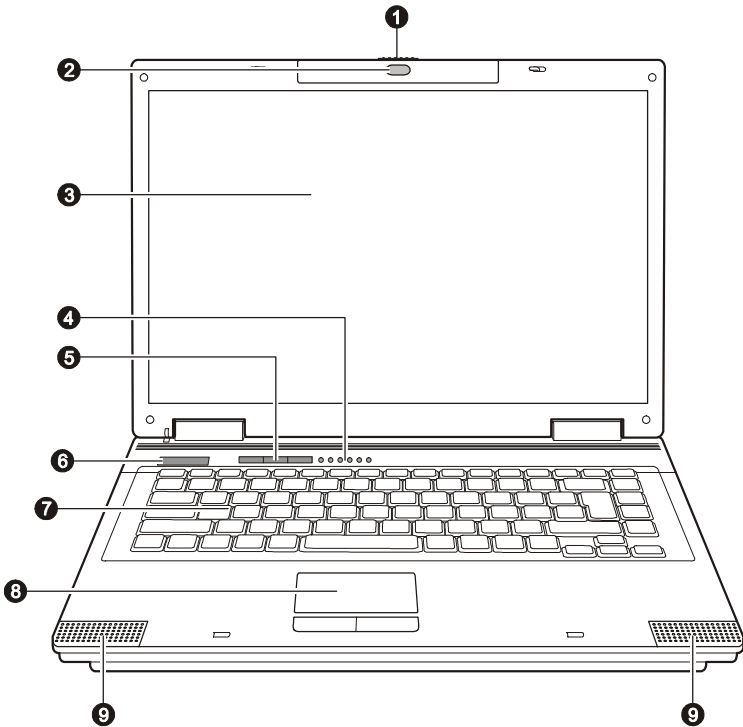



Ref	Component	Description	See Also
❶	<b>Battery Pack</b>	Supplies power to your computer when external power is not connected.	P. 3-3
❷	<b>WLAN Card Slot</b>	Inside is the optional Mini PCI-E WLAN card.	P. 2-21
❸	<b>Memory Slot</b>	Inside is the memory slot for expanding the memory size.	
❹	<b>CPU Socket</b>	Inside is the CPU.	
❺	<b>Hard Disk Drive Compartment</b>	Inside is the hard disk drive.	

# Top-open Components



Ref	Component	Description	See Also
1	Top Cover Latch	Locks the top cover.	
2	CMOS Camera Lens (Optional)	Allows you to use your computer's optional camera function.	
3	LCD Screen	Displays the output of the computer.	P. 2-16

Ref	Component	Description	See Also
<b>4</b>	<b>Indicators</b>	Show the current status of the computer's devices.	
		WLAN indicator Glow in green when the WLAN radio is on.	P. 2-22
		Power status indicator Glow in green when the computer is turned on. Blinks green the computer is in Sleep mode.	
		Battery Charge indicator Glow in green when the battery is fully charged and connected to AC power. Glow in amber when the battery is being charged. Blinks amber when the battery is almost completely discharged.	P. 2-6
		Caps Lock indicator	P. 2-6
		Num Lock indicator	P. 2-6
		DVD drive / Hard disk drive in-use indicator	P. 2-22
<b>5</b>	<b>Easy Start Buttons</b>	Provide a quick way to launch programs.	
		Starts Internet Explorer.	P. 2-4
		Starts Microsoft® Outlook.	P. 2-4
	<b>P1</b>	P1 (Program 1 – user customized) quick launch key.	P. 6-3
<b>6</b>	<b>Power Button</b> 	Turns the computer power ON and OFF.	P. 1-4
<b>7</b>	<b>Keyboard</b>	Serves as the data input device of the computer.	P. 2-4
<b>8</b>	<b>Touchpad</b>	Serves as the pointing device of the computer.	P. 2-11
<b>9</b>	<b>Stereo Speaker</b>	Sends out sound and voice from the computer.	P. 2-17

# Where to Go from Here

As your computer is ready for operation, you may want to do any of the following now:

<b>For this purpose...</b>	<b>Do this...</b>
To know more about the computer...	Go on to the next chapter.
To install the operating system if your dealer has not already done so...	See the operating system manual.
To know more about the operating system...	Read the operating system manual.
To install the drivers if your dealer has not already done so...	See Chapter 6.
To set a power-on password...	Read the operating system manual.
To charge the battery pack for the first time...	See “Charging the Battery Pack” in Chapter 3.

# *Operating Your Computer*

This chapter provides information about the use of the computer.

If you are new to computers, reading this chapter will help you learn the operating basics. If you are already a computer user but are new to notebook computers, you may choose to read only the parts containing information unique to your computer.

Described in this chapter are the operating basics of these components:

- Keyboard
- Touchpad
- DVD drive

And these features:

- Starting and stopping the computer
- Video features
- Audio features
- Communication features

# Starting and Stopping the Computer

There are a number of ways to start and stop the computer.

## Starting the Computer

You always start the computer using the power button.

A computer starts up with an operating system (OS) existing on the storage device such as the hard disk and optical disc. The computer will automatically load the OS after you turn it on. This process is called booting.

**NOTE:** An operating system is the platform for all your software application programs to run on. Your computer uses the Microsoft Windows Vista operating system.

## Stopping the Computer

When you finish a working session, you can stop the computer by turning off the power or leaving the computer in Sleep or Hibernation mode:

To stop in this mode...	Do this...	To start up or resume again
Off	<p>Follow the shutdown procedure of your operating system. This can prevent loss of unsaved data or damage to your software programs.</p> <p>If the system is locked up because of hardware or software problems, press the power button to turn off the computer.</p>	Press the power button.
Sleep	<p>Depending on your settings in Windows, you can place the computer in Sleep mode by:</p> <ul style="list-style-type: none"><li>• Closing the display cover</li><li>• Pressing the <b>Fn+F12</b> hot key</li><li>• Pressing the power button</li></ul>	Press any key.

To stop in this mode...	Do this...	To start up or resume again
Hibernation	Depending on your settings in Windows, you can place the computer in Hibernation mode by: <ul style="list-style-type: none"><li>• Closing the display cover</li><li>• Pressing the power button</li></ul>	Press the power button.

---

If you choose to stop in Sleep or Hibernation mode, you can return to where you left off the next time you start up the computer. (See “Power Management” in Chapter 3 for more information.)



# Using the Easy Start Buttons

**NOTE:** To take advantage of the Easy Start buttons feature, the ESB driver supplied with your computer must be installed. (See chapter 6 for details.)

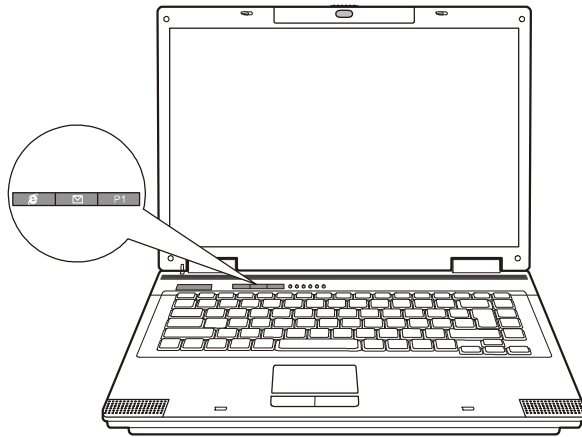
The Easy Start buttons are three pre-defined buttons located on the left above the keyboard.



The Easy Start buttons allow you to start the frequently-used programs with one single press of a button (from left to right):

-  Internet Explorer
-  Microsoft® Outlook
- **P1** P1 (Program 1 – user customized) quick launch key (see chapter 6 for details)



# Using the Keyboard





Your keyboard has all the standard functions of a full-sized computer keyboard plus an **Fn** key added for specific functions.







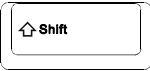

The standard functions of the keyboard can be further divided into four major categories:

- Typewriter keys
- Cursor-control keys
- Numeric keys
- Function keys

## Typewriter Keys

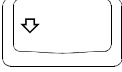
Typewriter keys are similar to the keys on a typewriter. Several keys are added, such as the **Ctrl**, **Alt**, **Esc** keys and lock keys, for special purposes. When the lock keys are pressed, their corresponding indicators light up.

Key	Description
	The Control key is normally used in combination with other keys for program-specific functions.
	The Alternate key is normally used in combination with other keys for program-specific functions.
	The Escape key is usually used for stopping a process. Examples are exiting a program and canceling a command. The function depends on the program you are using.
	The Shift key is used with alphabet letter keys to produce uppercase letters when typing. It is also used in combination with other keys for program-specific functions.
	The Backspace key moves the cursor left one space and deletes the character in that space.





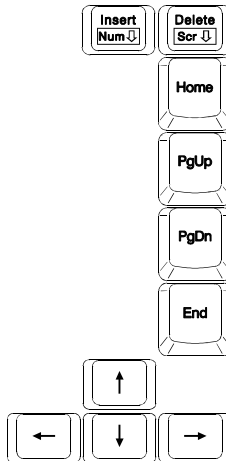





Key	Description
	Pressing <b>Fn</b> and this key toggles the Num Lock on and off. When on (  light on), the Num Lock activates the numeric keys.
	Pressing <b>Fn</b> and this key toggle Scroll Lock on and off. When on the screen moves one line up or down when you press  or  arrow key. Scroll Lock does not work for all programs.
	Pressing this key toggles the Caps Lock on and off. When on (  light on), the Caps Lock keeps the letter keys in uppercase.
	The Pause key temporarily stops screen scrolling. Scroll Lock does not work for all programs.
	The Print Screen key prints the displayed screen. Print screen does not work for all programs.

## Cursor-Control Keys



**NOTE:** The word “cursor” refers to the indicator on the screen that lets you know exactly where on your screen anything you type will appear. It can take the form of a vertical or horizontal line, a block, or one of many other shapes.

Cursor-control keys are generally used for editing purposes. They are:

Key	Description
	Moves the cursor left one space.
	Moves the cursor right one space.
	Moves the cursor up one line.
	Moves the cursor down one line.
	Moves the page up.
	Moves the page down.
	Moves the cursor to the beginning of the line or document.
	Moves the cursor to the end of the line or document.
	Switches typing between insert and overwrite modes. Insert mode means any character typed will be inserted to the current cursor position; overwrite mode means any character typed will overwrite the text in the current cursor position.
	Deletes the character to the right of the cursor and moves the following text left one space.

# Numeric Keypad

A 15-key numeric keypad is embedded in the typewriter keys as shown next:

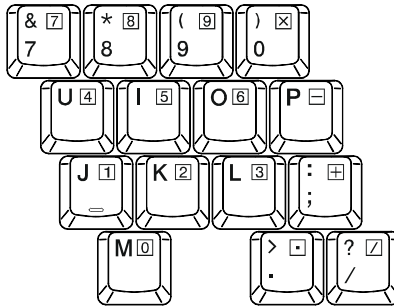

Numeric keys facilitate entering of numbers and calculations. When Num Lock is on, the numeric keys are activated, which means you can use these keys to enter numerals.

## NOTE:

- When the numeric keypad is activated and you need to type the English letter in the keypad area, you can either turn Num Lock off or you can press the **Fn** key and then the letter key without turning Num Lock off.
- Some software may not be able to use the numeric keypad on the computer. If so, use the numeric keypad on an external keyboard instead.

# Euro Symbol



Windows supports the Euro dollar sign €, you can press the sign on the US and UK keyboards.

- To press the Euro sign on a United States-International keyboard, hold down either of the **Alt** keys and press **5** (which has a Euro sign on it).

- To press the Euro sign on a United States 101 keyboard, hold down either of the **Alt** keys and type **0128** on the numeric keypad of your keyboard.
- To press the Euro sign on an UK keyboard, hold down the **Alt Gr** key and press **4** (which has a Euro sign on it).

## Windows Keys

The keyboard has two keys that perform Windows-specific functions:  Windows Logo key and  Application key.

The  Windows Logo key opens the **Start** menu and performs software-specific functions when used in combination with other keys. The  Application key usually has the same effect as a right mouse click. (See your Windows manual for more information.)

## Function Keys

On the top row of the keys are the function keys: **F1** to **F12**. Function keys are multi-purpose keys that perform functions defined by individual programs.

Hot key functions are assigned to the **F1**, **F3**, **F4**, **F5**, **F6**, **F7**, **F10**, **F11**, and **F12** keys by your computer. (See “Hot Keys” later in this chapter for information.)





## Fn Key

The **Fn** key, at the lower left corner of the keyboard, is used with another key to perform the alternative function of a key. The letter “Fn” and the alternative functions are identified by the color of blue on the keytop. To perform a desired function, first press and hold the **Fn** key, then press the other key.

# Hot Keys

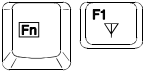
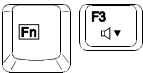
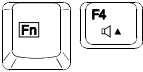
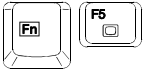
Hot keys refer to a combination of keys that can be pressed any time to activate special functions of the computer. Most hot keys operate in a cyclic way. Each time a hot key combination is pressed, it shifts the corresponding function to the other or next choice.

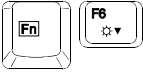
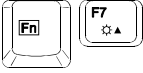
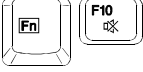
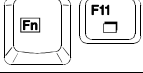
You can easily identify the hot keys with the icons imprinted on the keytop. The hot keys are described next.

Key	Description
	Switches the wireless LAN radio on and off. <b>NOTE:</b> This function works only if an optional mini PCI-E wireless LAN card is installed.
	Decreases the sound volume.
	Increases the sound volume.
	Switches the display output to one of the following when external devices are connected. Upon booting the system with CRT: 
	Decreases the LCD brightness (8 levels).
	Increases the LCD brightness (8 levels).
	Switches the system sound output off (mute) and on.
	Switches the display on and off.
	Serves as the sleep button that you can define with Windows' <b>Power Options</b> . (See the "Power Management" in Chapter 3.)

# Using the Touchpad

**CAUTION:** Do not use a sharp object such as a pen on the touchpad. Doing so may damage the touchpad surface.

**NOTE:** For optimal performance of the touchpad, keep your fingers and the pads clean and dry. When tapping on the pad, tap lightly. Do not use excessive force.

The touchpad is a pointing device that allows you to communicate with the computer by controlling the location of the pointer on the screen and making selection with the buttons.

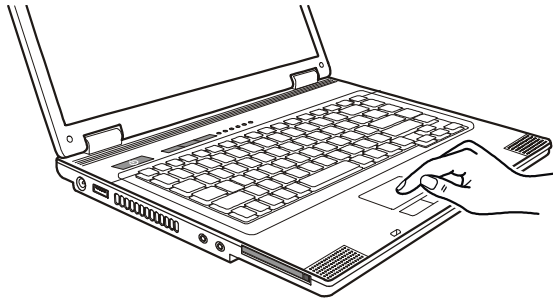

The touchpad consists of a rectangular pad and a left and right buttons. To use the touchpad, place your forefinger or thumb on the pad. The rectangular pad acts like a miniature duplicate of your display. As you slide your fingertip across the pad, the pointer (also called cursor) on the screen moves accordingly. When your finger reaches the edge of the pad, simply relocate yourself by lifting the finger and placing it on the other side of the pad.

Here are some common terms that you should know when using the touchpad:

Term	Action
Point	Move your finger on the pad until the cursor points to the selection on the screen.
Click	Press and release the left button. –or– Tap gently anywhere on the pad.
Double-click	Press and release the left button twice in quick succession. –or– Tap twice on the pad rapidly.
Drag and drop	Press and hold the left button, then move your finger until you reach your destination (drag). Finally, release the button (drop) when you finish dragging your selection to the destination. The object will drop into the new location. –or– Gently tap twice on the pad and on the second tap, keep your finger in contact with the pad. Then, move your finger across the pad to drag the selected object to your destination. When you lift your finger from the pad, the selected object will drop into place.
Scroll	To scroll is to move up and down or left and right in the working area on the screen.  To move vertically, place your finger on the right or left edge of the pad and slide your finger up and down along the edge. To move horizontally, place your finger on the top or bottom edge of the pad and slide your finger left and right.  This function works only after you install the touchpad driver supplied with the computer and it may not work for all applications.

**TABLE NOTE:** If you swap the left and right buttons, “tapping” on the touchpad as an alternative method of pressing the left button will no longer be valid.



## Configuring the Touchpad

You may want to configure the touchpad to suit your needs. For example, if you are a left-handed user, you can swap the two buttons so that you can use the right button as the left button and vice versa. You can also change the size of the on-screen pointer, the speed of the pointer, and so on.

To configure the touchpad, go to **Control Panel → Hardware and Sounds → Mouse Properties**. However, you can install the touchpad driver supplied with your computer to take advantage of more powerful features. (For information on installing the driver, see “How to Use the Driver Disc” in Chapter 6.)

# Using the DVD Drive

Your computer comes with a DVD drive, usually configured as drive D.

Depending on the model, your drive is one of the following:

- **Combo drive** can work both as a DVD drive (reading DVD discs in addition to CDs, audio CDs and CD-R/-RW discs), and also as a CD recorder (writing to CD-R/-RW discs).
- **DVD Dual drive** besides the Combo drive function, can write to DVD+R/+RW/-R/-RW discs.
- **Super Multi drive** besides the Combo drive function, can write to DVD+R/+RW/-R/-RW and DVD-RAM discs.

## CAUTION:

- When inserting a disc, do not use force.
- Make sure that the disc is correctly inserted into the tray, and then close the tray.
- Do not leave the DVD tray open. Also, avoid touching the lens in the tray with your hand. If the lens becomes dirty, the DVD drive may malfunction.
- Do not wipe the lens using materials with rough surface (such as paper towel). Instead, use a cotton swab to gently wipe the lens.

FDA regulations require the following statement for all laser-based devices:

“Caution, Use of controls or adjustments or performance of procedures other than those specified herein may result in hazardous radiation exposure.”

**NOTE:** The DVD drive is classified as a Class 1 laser product. This label is located on the DVD drive.

**CLASS 1 LASER PRODUCT  
LASER KLASSE 1**

**NOTE:** For DVD and Combo drives only.

This product incorporates copyright protection technology that is protected by method claims of certain U.S. patents and other intellectual property rights owned by Macrovision Corporation and other rights owners. Use of this copyright protection technology must be authorized by Macrovision Corporation, and is intended for home and other limited viewing uses only unless otherwise authorized by Macrovision Corporation. Reverse engineering or disassembly is prohibited.

# Inserting and Removing a Disc

Follow this procedure to insert or remove a disc:

1. Turn on the computer.
2. Press the eject button and the DVD tray will slide out partially. Gently pull on it until it is fully extended.
3. To insert a disc, place down the disc in the tray with its label facing up. Slightly press the center of the disc until it clicks into place.

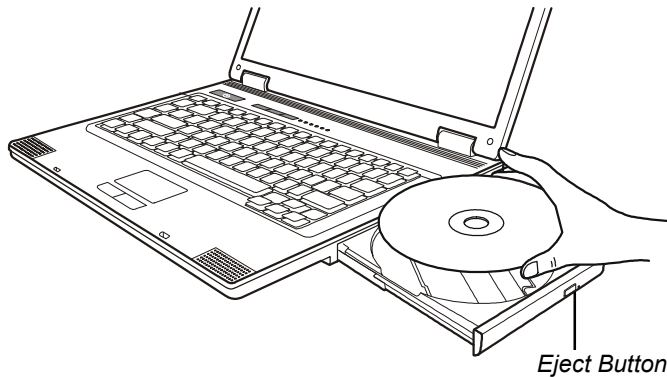

To remove a disc, hold the disc by its outer edge and lift it up from the tray.

4. Gently push the tray back into the drive.

**NOTE:** In the unlikely event that you are unable to release the DVD tray by pressing the eject button, you can manually release the disc. (See “DVD Drive Problems” in Chapter 8.)

# Using the Video Features

The video subsystem of your computer features:

- 15.4-inch TFT (Thin-Film Transistor) color LCD display with 1280×800 WXGA resolution
- Multi-display capability, which allows you to expand your desktop on the screen to another display device so that you have more desktop space to work on.
- Power Management

## NOTE:

- Before using the multi-display capability or taking advantage of the enhanced video capabilities, the video driver supplied with your computer must be installed. (See chapter 6 for details.)
- The computer enters the Sleep or Hibernation mode when the LCD is closed. If you want to use the computer with the LCD closed, set *Do Nothing* to the “When I Close the lid” option in the **Power Options** → **System Settings** Properties. Thus the computer does not enter the Sleep or Hibernation mode when the LCD is closed.

## Configuring the Display Modes

**NOTE:** When using an external CRT monitor, the resolution depends on the CRT monitor’s supported resolution.

Your computer has been set to a default resolution and number of colors before shipment. You can view and change display settings through your operating system. See your operating system documentation or online help for specific information.

For displaying in higher resolutions, you can connect an external monitor that supports higher resolutions. (See “Connecting an External Monitor” in Chapter 4 for more information.)

# Using the Audio Features

**NOTE:**

- To take advantage of the enhanced audio capabilities, the audio driver supplied with your computer must be installed. (See chapter 6 for details.)
- If you experience interference while recording, try lowering the microphone recording volume.

The audio subsystem of your computer features:

- External audio connectors (❶) and
- Set of speakers (❷)

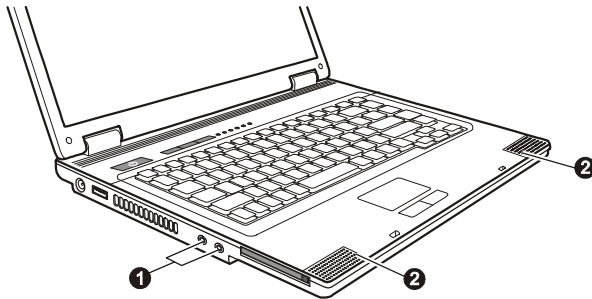



Ways of playing and recording sound vary with the operating system used. See your operating system documentation or online help for specific information.

# Connecting Audio Devices

For higher audio quality, you can send or receive sound through external audio devices.

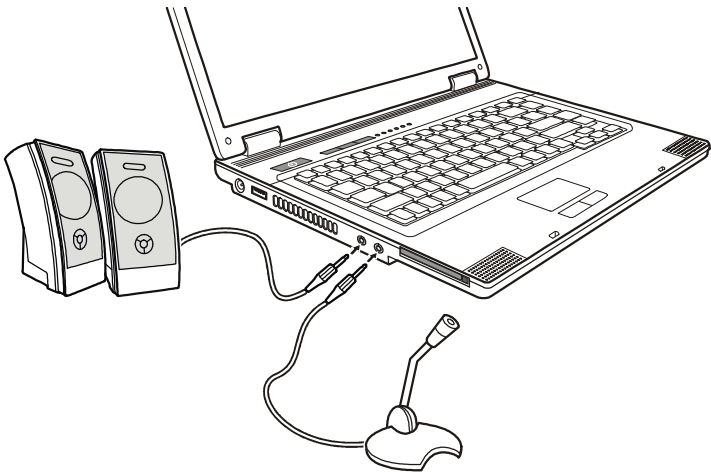
**NOTE:** After connecting an external audio device, make sure that you specify the use of the correct audio device in Windows.



- **Audio Output Connector** (  ) can be connected to speakers, headphones, or earphone set.
- **Microphone Connector** (  ) can be connected to an external microphone for recording voice or sound.

**NOTE:** When using the external speakers/headphones or microphone, you cannot use the internal one.

# Using the Communication Features

## Using the Modem (Optional)

**NOTE:**

- Depending on your model, the RJ-11 connector may not have any function.
- To take advantage of the modem feature, the modem driver supplied with your computer must be installed. (See chapter 6 for details.)

The optional internal 56 K fax/data modem allows you to use the telephone line to communicate with others by fax, email, or connect to an online service or bulletin board.

To connect the telephone line to the modem, connect one end of the modem cable to the RJ-11 connector on the computer and the other end to the telephone line.

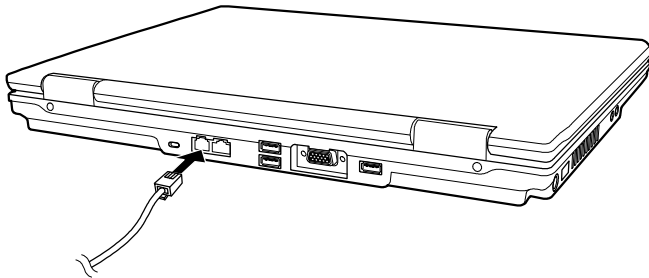

**NOTE:**

- When using the communication software, you may have to disable power management.
- Set the COM port of the modem to COM3.
- Set parameters such as modem speed (baud rate) and line type (pulse dialing or tone dialing).
- Do not enter the Sleep mode when using the communication software.

## Using the LAN

**NOTE:** To take advantage of the LAN feature, the LAN driver supplied with your computer must be installed. (See chapter 6 for details.)

The internal 10/100 Mbps LAN (Local Area Network) module allows you to connect your computer to a network. It supports data transfer rate up to 100 Mbps.

To connect the network cable to the LAN module, connect one end of the LAN cable to the RJ-45 connector on the computer and the other end to the network hub.

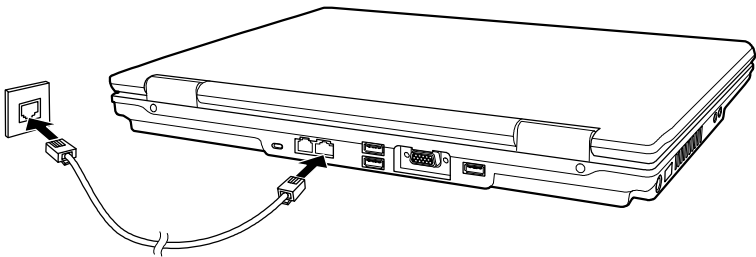



## Using the Wireless LAN (Optional)

Depending on your model, an internal mini PCI-E wireless LAN (WLAN) card may have been pre-installed by your computer manufacturer at the factory. This card allows you to access corporate networks or the Internet in a wireless environment.

The WLAN features include:

- Peer-to-Peer (Ad-Hoc) and Access Point (Infrastructure) modes support
- WEP (Wired Equivalent Privacy) 64/128-bit data encryption
- IEEE 802.11a/b/g or 802.11b/g standard compliance

Technology	802.11a	802.11b	802.11g
Stated Maximum Throughput (Mbps)	54	11	54
Data Rates (Mbps)	54, 48, 36, 24, 18, 12, 9, 6	11, 5.5, 2, 1	54, 36, 18, 9
Band (GHz)	5.15 ~ 5.35	2.412 ~ 2.462	2.4
Modulation Technology	OFDM (Orthogonal Frequency Division Multiplexing)	DSSS (Direct Sequence Spread Spectrum)	OFDM (Orthogonal Frequency Division Multiplexing)

**| NOTE:** 802.11g mode is backward compatible with 802.11b mode.

To take advantage of the WLAN feature, make sure that the WLAN driver is installed correctly. (See chapter 6 for details.) If your WLAN card was provided by your dealer instead of the computer manufacturer, contact your dealer for the correct driver to use.

## Turning Off/On the WLAN Radio

**NOTE:** The FAA (Federal Aviation Agency) has deemed it unsafe to operate wireless devices in aircraft as this may interfere with flight safety. Remember to turn off wireless LAN when using your computer in the airplane.

Your computer has a built-in **Fn+F1** WLAN hot key to switch the WLAN on/off (see “Hot Keys” in Chapter 2).

If you need to temporarily turn off the radio, press **Fn+F1**. To resume network connection, press **Fn+F1** again.

It takes approximately 30 seconds for your computer to make a successful WLAN connection and approximately 10 seconds to disconnect.

## Connecting to a Wireless Network

1. Make sure that the WLAN radio is on.
2. Right-click the **Wireless Network Connection** icon  located on the Windows system tray and select **Connect to a network**.
3. If any wireless network is detected, the following window appears on screen. Click the **Show** drop down menu and select **Wireless**.

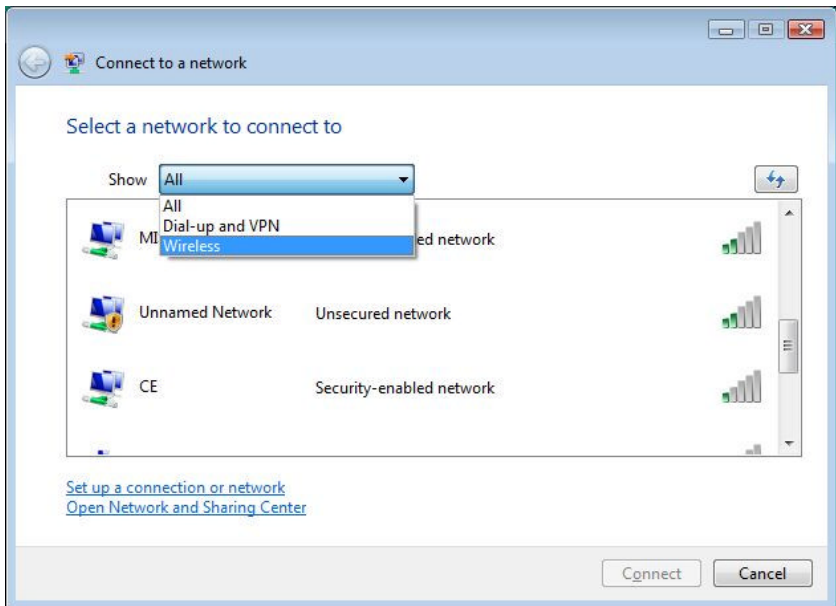

4. Select a wireless network to connect to by clicking a selection, then click **Connect**.
5. Depending on the settings, you may be asked to enter a WEP key (refer to your Windows online help for more information on setting a wireless network connection).

# *Managing Power*

Your computer operates either on external AC power or on internal battery power.

This chapter tells you how you can effectively manage power. To maintain optimal battery performance, it is important that you use the battery in the proper way.

The topics in this chapter include:

- What is an AC adapter
- How to charge the battery pack
- When and how to initialize the battery pack
- How to check the battery level
- How to replace the battery pack
- What happens when the battery is low and what actions to take
- What is Power Management
- How to save power

# AC Adapter

**CAUTION:**

- The AC adapter is designed for use with your computer only. Connecting the AC adapter to another device can damage the adapter.
- The AC power cord supplied with your computer is for use in the country where you purchased your computer. If you plan to go overseas with the computer, consult your dealer for the appropriate power cord.
- When you disconnect the AC adapter, disconnect from the electrical outlet first and then from the computer. A reverse procedure may damage the AC adapter or computer.
- When unplugging the connector, always hold the plug head. Never pull on the cord.

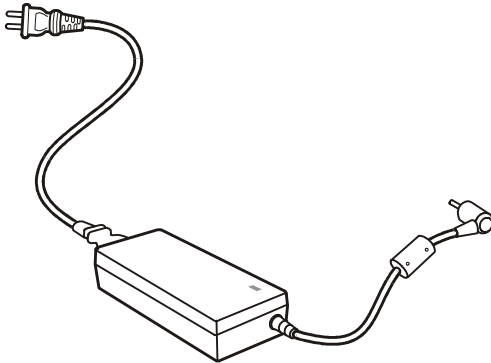

The AC adapter serves as a converter from AC (Alternating Current) to DC (Direct Current) power because your computer runs on DC power, but an electrical outlet usually provides AC power. It also charges the battery pack when connected to AC power.

The adapter operates on any voltage in the range of 100~240 V AC.

# Battery Pack

The battery pack is the internal power source for the computer. It is rechargeable using the AC adapter.

The operating time of a fully charged battery pack depends on how you are using the computer. When your applications often access peripherals, you will experience a shorter operating time.

**NOTE:** Care and maintenance information for the battery is provided in the “Battery Pack Guidelines” section in Chapter 7.

## Charging the Battery Pack

**NOTE:**

- Charging will not start if the battery's temperature is below 0 °C (32 °F) or above 45 °C (113 °F).
- The charging process will stop and the Battery Charge Indicator flashes red when the battery's temperature gets above 60 °C (140 °F). If this happens, the battery pack may be damaged. Please contact your dealer.
- During charging, do not disconnect the AC adapter before the battery has been fully charged; otherwise you will get a prematurely charged battery.

To charge the battery pack, connect the AC adapter to the computer and an electrical outlet. The Battery Charge Indicator (  ) on the computer glows amber to indicate that charging is in progress. You are advised to keep the computer power off while the battery is being charged. When the battery is fully charged, the Battery Charge Indicator glows green.

The charging times are as follows:

Battery Type	Charging Time	
	Computer is Off	Computer is On and in Idle State
4-cell (2200 mAH)	1.7 hours	2.7 hours
6-cell (4400 mAH)	3.0 hours	5.3 hours

**CAUTION:** After the computer has been fully recharged, do not immediately disconnect and reconnect the AC adapter to charge it again. Doing so may damage the battery.

**NOTE:** The battery level may automatically lessen due to the self-discharge process (0.21 % per day), even when the battery pack is fully charged (100 %). This happens no matter if the battery pack is installed in the computer.

## Initializing the Battery Pack

You need to initialize a new battery pack before using it for the first time or when the actual operating time of a battery pack is much less than expected.

Initializing is the process of fully charging, discharging, and then charging. It can take several hours.

1. Make sure that the computer power is turned off. Connect the AC adapter to fully charge the battery pack.
2. After the battery pack is fully charged, turn on the computer. When the message “**Click mouse or press Enter for Menu**” appears, click the touchpad’s left button or press the **Enter** key to invoke the program.
3. A small window appears, select “**Launch BIOS Setup.**”
4. Disconnect the AC adapter and leave the computer on until the battery is fully discharged. The computer will shut down automatically.
5. Connect the AC adapter to fully charge the battery pack.

## Checking the Battery Level

**NOTE:** Any battery level indication is an estimated result. The actual operating time can be different from the estimated time, depending on how you are using the computer.

You can check the approximate battery level using the battery meter function of the operating system. To read the battery level in Windows, click the  icon on the system tray.

# Replacing the Battery Pack

**CAUTION:**

- There is danger of explosion if the battery is incorrectly replaced. Replace the battery only with the computer manufacturer's optional battery packs. Discard used batteries according to the dealer's instructions.
- Do not attempt to disassemble the battery pack.

If you often rely on battery power for a long period of time while traveling, you may consider the purchase of an additional battery pack from your dealer and keep it with you in a fully charged state as a backup.

To replace the battery pack, follow these steps:

1. Make sure that the computer is not turned on or connected to AC power.
2. Place the computer upside down.
3. Press the two battery release levers inward and lift it up to remove the battery pack off the computer.

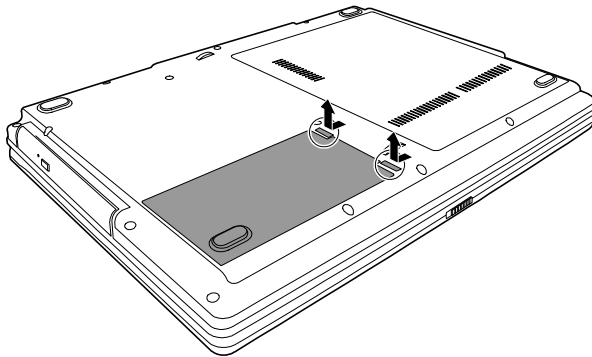



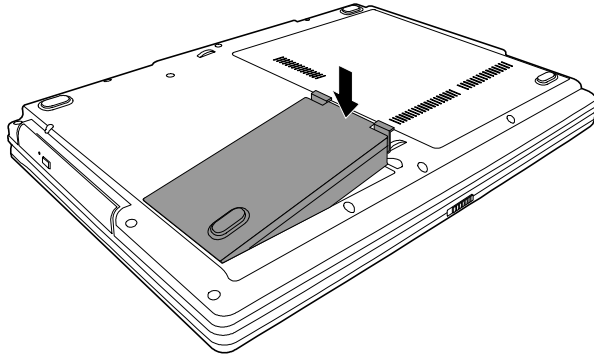

4. Align the side of a spare battery pack with the side of the battery compartment and gently push the battery pack into place. The two battery release levers would click into position.



# Battery Low Signals and Actions

The battery icon  changes appearance to display the current state of the battery so that you can see how much charge remains (Windows default setting). When the battery charge is above 25 % the battery icon is green. When the battery charge reaches 25 % a yellow triangle with an exclamation point (!) appears above the green battery icon. When the charge reaches the low battery level a red circle with a white “X” appears above the green icon. The computer’s Battery Charge Indicator (  ) blinks red to alert you to take actions.

Immediately save your data upon Battery Low. The remaining operating time depends on how you are using the computer. If you are using the audio subsystem, ExpressCard, hard or USB flash disk, the battery might run out of charge very quickly.

Always respond to Battery Low by placing your computer on Hibernation mode, turning off the computer, or connecting the AC adapter.

## **CAUTION:**

- If you are using an ExpressCard, do not access the card during battery low periods. This is because the access may take longer than the time it takes the battery to run out of charge, thus making your access to the card unsuccessful.
- If you fail to save your data when the battery completely runs out of charge, then you lose your data.

# Power Management

Your computer supports ACPI (Advanced Configuration and Power Interface) for power management. The power management feature allows you to reduce the power consumption for energy saving.

With an ACPI-compliant operating system such as Windows Vista, power supply to different computer components is controlled on an as-needed basis. This allows maximum power conservation and performance at the same time.

In general, Windows' power management works in this way:

What...	When...
Power to the hard disk is turned off	When the hard disk has been idle for a set period.
Power to the display is turned off	When the display has been idle for a set period.
The computer enters the Sleep mode. The hard disk and display are turned off and the entire system consumes less power.	When the entire system has been idle for a set period.
	When you press the <b>Fn+F12</b> hot key. *
	When you close the cover. *
The computer enters the Hibernation mode. (See the next subsection for more information.)	When you press the power button. *
	When the entire system has been idle for a set period.
	When you press the <b>Fn+F12</b> hot key. *
	When you close the cover. *
	When you press the power button. *

\* Depends on your settings in Windows.

For detailed information on power management, see Windows' Help.

# Hibernation

**NOTE:** Make sure that the hibernation feature is enabled in the “When I press the power button,” “When I press the sleep button,” and “When I close the lid” of the **Power Options** → **System Settings** Properties from the **Control Panel** → **Mobile PC** in Windows Vista.

Hibernation is a very useful feature. People frequently open many applications when they use computers. It takes some time to get all these applications open and running, and normally they all have to be closed before the computer can be turned off.

When you use the hibernation feature, you do not have to close the applications. The computer stores the state of your computer to a file on the hard disk and then shuts down. The next time you turn on your computer, you return to exactly where you left off.

# Power-Saving Tips

Aside from enabling your computer's power saving mode (see previous section), you can do your part to maximize the battery's operating time by following these suggestions.

- Do not disable Power Management. Choose a Windows power plan that saves power. A power plan is a collection of hardware and system settings that control how your computer manages power.
- Decrease the LCD brightness to the lowest comfortable level.
- Shorten the length of time before Windows turn off the display.
- Many USB devices use power just by being connected. If you use a USB mouse, you can save power by disconnecting the mouse and using the touchpad. If you use a USB flash drive, unplug it when you are not using it.
- If you work with an application that uses an ExpressCard, exit the application when you finish using it.
- If you have an ExpressCard installed, remove it when not in use. Some ExpressCards drain power even while they are inactive.
- Deactivate the WLAN function if you are not using it. (See “Turning Off/On the WLAN Radio” in Chapter 2.)
- Turn off the computer when you are not using it.

# *Expanding Your Computer*

You can expand the capabilities of your computer by connecting other peripheral devices. When using a device, be sure to read the instructions accompanying the device together with the relevant section in this chapter.

This chapter gives guidelines on installing and using these devices:

- External monitor
- USB device
- ExpressCard

# Connecting an External Monitor

If you want the benefits of a larger display screen with higher resolution, you can connect an external CRT monitor to your computer. Follow this procedure to connect an external monitor:

1. Make sure that the computer is not turned on.
2. Plug the monitor's signal connector to the computer's VGA connector.

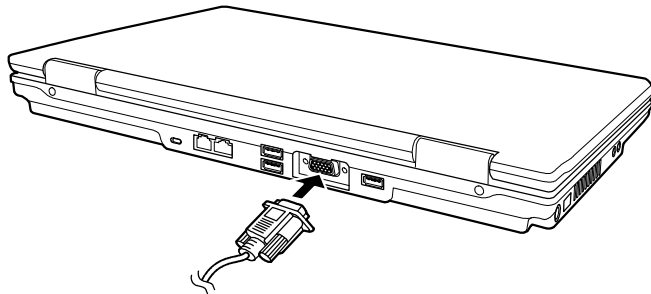

3. Plug one end of the monitor's power cord into the power socket on the monitor and the other end to an electrical outlet.
4. To use the monitor, turn on the monitor before turning on the computer.
5. The monitor should respond by default. If not, you can switch the display to the monitor or to both (simultaneous display), or to multi-display by pressing the **Fn+F5** hot key. In Windows, you can also change the display through the **Display Settings** Properties.
6. You can change display settings through your operating system. See your operating system documentation or online help for specific information.

**CAUTION:** Do not disconnect the external monitor while the computer is in Sleep or Hibernation mode. If no external monitor is connected when the computer resumes, the LCD might not display properly.

**NOTE:** Make sure that the VGA driver is installed correctly.

# Connecting a USB Device

Your computer has four USB ports for connecting USB devices, such as a digital camera, scanner, printer, modem, and mouse.

USB (Universal Serial Bus) is specified to be an industry standard extension to the PC architecture. It supports “Plug-and-Play” technology so you can install and remove USB devices without turning off the computer. With its multiple connection capability, up to 127 devices can be connected in a daisy-chain configuration. In addition, you can use a USB hub that converts a single USB connector into multiple ports where USB devices can be connected.

The USB ports support transfer rates up to 12 MB/s for USB 1.1 devices and 480 MB/s for USB 2.0 devices.

To connect a USB device, simply plug the device cable to one of the USB ports.

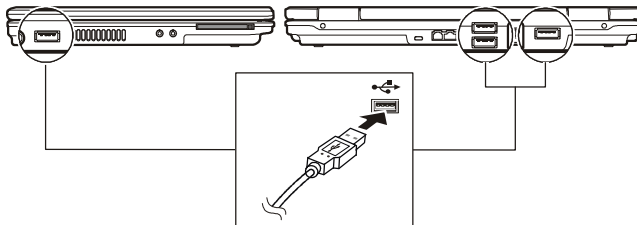



# Using ExpressCards

**NOTE:** The ExpressCard interface is not compatible with the PC card interface. You need optional adapters for using PC cards on your computer.

Your computer has an ExpressCard slot.

ExpressCard supports the PCI Express and USB 2.0 serial data interfaces (supporting speeds of up to 2.5 Gbps and 480 Mbps respectively), improving speed in data transfer while conserving power usage.

## ExpressCard Type

The ExpressCard slot can accommodate a 54 mm (ExpressCard/54) or 34 mm (ExpressCard/34) wide ExpressCard. Typical ExpressCards support a very extensive range of applications including memory, wired and wireless communication cards, and security devices.

Shown next are the appearances of ExpressCards for your reference.

**ExpressCard/54**



**ExpressCard/34**



# Inserting and Removing an ExpressCard

To insert an ExpressCard:

1. Locate the ExpressCard slot on the left side of the computer.
2. Slide the ExpressCard, with its label facing up, all the way into the slot until the rear connectors click into place.

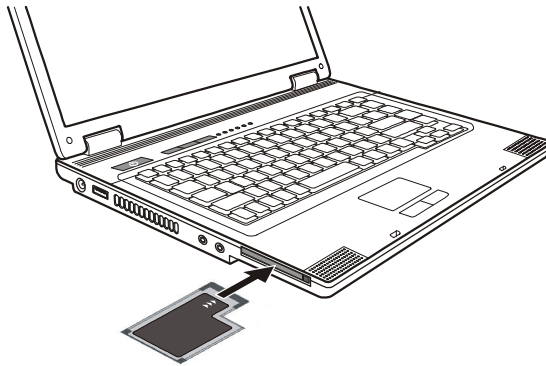

3. When a new card is seated, the computer will detect it and try to install the appropriate driver. Follow the on-screen instructions to complete the process.

To remove an ExpressCard:

1. Double-click the **Safely Remove Hardware** icon  found on the Windows system tray and the **Safely Remove Hardware** window appears on screen.
2. Select (highlight) the ExpressCard from the list to disable the card.
3. Push the ExpressCard slightly to release the card.
4. Pull the card out of the slot.

# Internal Components Upgrade

You can upgrade your computer by changing the CPU and hard disk or adding memory. However, to avoid damage during the installation procedure, please ask your dealer for help. Do not install an internal component by yourself.

# *Using BIOS Setup*

BIOS Setup Utility is a program for configuring the BIOS (Basic Input/Output System) settings of the computer.

BIOS is a layer of software, called firmware, that translates instructions from other layers of software into instructions that the computer hardware can understand. The BIOS settings are needed by your computer to identify the types of installed devices and establish special features.

This chapter tells you how to use the BIOS Setup program.

# When and How to Use BIOS Setup

## When to Use

You need to run BIOS Setup Utility when:

- You see an error message on the screen requesting you to run BIOS Setup Utility.
- You want to restore the factory default settings.
- You want to modify some specific settings according to the hardware.
- You want to modify some specific settings to optimize the system performance.

## Starting BIOS Setup

### NOTE:

- The BIOS Setup Utility screens shown in this chapter are for your reference only. The actual items or settings on your computer may differ.
- The BIOS Setup Utility program may have been updated after the publication of this manual.
- The settings you select in your operating system might override similar settings in BIOS Setup Utility.

To run BIOS Setup Utility, press the **Enter** key or click the left touchpad button when the prompt appears on the screen during system startup. The prompt shows up on the screen for only a few seconds. You must press the **Enter** key or click the left touchpad button quickly. A small window appears, select **Launch BIOS Setup**. The BIOS Setup Utility main screen appears as shown next.

Main		Advanced	Boot	Exit	
System Time:	[16:34:08]				Item Specific Help
System Date:	[2007-06-14]				
Hard Disk CD-ROM	[Fujitsu MHV2040AT-(PM)] [PHILIPS DVD+/-RW SDV08820]				<Tab>, <Shift-Tab>, or <Enter> selects field.
System Memory:	633 KB				
Extended Memory:	489472 KB				
System BIOS Version:	R0.07E				
KBC BIOS Version:	R1.00				
F1 Help Esc Exit	↓↑ Select Item ←→ Select Menu	+/- Change Values Enter Select	▶ Sub-Menu	F9 Setup Defaults F10 Save and Exit	

The BIOS Setup Utility screen can be divided into four areas:

- On the top is the menu bar containing the titles of the available menus. Each menu title brings a specific menu.
- The center column of the menu displays the current configuration information of the system, devices, and memory items.
- The right column of the menu provides more detailed information when a menu item is highlighted.
- On the bottom keyboard keys are displayed for navigating the screen.

# Moving Around and Making Selections

In most cases, you must go through two levels to complete the setting for an item: menu title and submenu.

Use the keyboard to move around and make selections. A brief description of keyboard usage is listed next:

<b>Key</b>	<b>Function</b>
← , →	Selects a menu title.
↑ , ↓	Selects an item or option.
+ , –	Changes the value.
<b>Enter</b>	1) Brings up the sub-menu when available. 2) Opens or closes the option window when an item is selected.
<b>Esc</b>	1) Displays the Exit menu. 2) Closes the option window if one is open.
<b>F1</b>	Displays help information.
<b>F9</b>	Changes the values to the setup defaults.
<b>F10</b>	Saves and exit the BIOS Setup Utility.

# Main Menu

The Main menu contains the system date and time settings of the system.

Main	Advanced	Boot	Exit
System Time:		[16:34:08]	
System Date:		[2007-06-14]	
Hard Disk		[Fujitsu MHV2040AT-(PM)]	
CD-ROM		[PHILIPS DVD+/-RW SDV08820]	
System Memory:		633 KB	
Extended Memory:		489472 KB	
System BIOS Version:		R0.07E	
KBC BIOS Version:		R1.00	
			Item Specific Help
			<Tab>, <Shift-Tab>, or <Enter> selects field.
F1 Help	↓↑ Select Item	+/- Change Values	F9 Setup Defaults
Esc Exit	←→ Select Menu	Enter Select ► Sub-Menu	F10 Save and Exit

**System Time** sets the system time.

**System Date** sets the system date.



# Advanced Menu

The Advanced menu contains the various system settings.

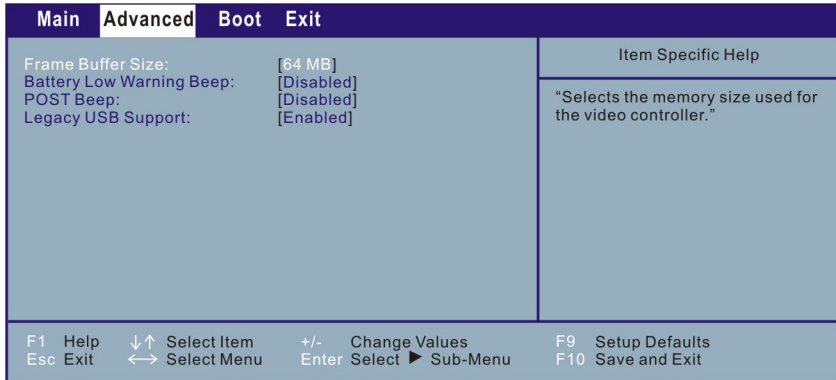

**Frame Buffer Size** sets the shared memory size of the video controller. The options are *64MB*, *128MB*, and *256MB*. Default setting is *64MB*.

**NOTE:**

- This item is for **Legacy VGA** and **SVGA mode** only. When under Windows mode, the frame buffer size is allocated directly by the VGA driver based on the size of your system memory.
- Increasing the frame buffer size may improve the video subsystem's performance, however it may decrease your system memory.

**Battery Low Warning Beep** sets if the system will beep once every 4 seconds to warn you against a low battery situation (capacity below 10 %). Not applicable when system is in POST (Power-On Self Test) stage or in BIOS Setup. The options are *Enabled* and *Disabled*. Default setting is *Disabled*.

**POST Beep** enables or disables the beep sound when POST (Power-On Self-Test) finishes. The options are *Enabled* and *Disabled*. Default setting is *Disabled*.

**Legacy USB Support** enables the system's support for Legacy USB device (e.g., mouse, flash disk, except keyboard) in DOS mode. The options are *Enabled* and *Disabled*. Default is *Enabled*.

# Boot Menu

The Boot menu sets the sequence of the devices to be searched for the operating system.

Main	Advanced	Boot	Exit
Boot priority order: 1. CD-ROM: MATSHITA DVD-RAM 2. USB FDC: MITSUMI USB FDD 3. HARD DISK: FUJITSU MHT2080AT 4. PCI BEV: VIA BootAgent 5. 6. 7. 8.  Excluded from boot order: : All IDE CD-ROM : All USB Floppy : All USB Key : All USB HDD : All USB CD-ROM : All USB ZIP : All USB LS120 : All PCI SCSI : All PCI BEV : Legacy Network Card : Bootable Add-in Card			Item Specific Help  Keys used to view or configure devices : Up and Down arrows select a device. <+> and <-> moves the device up or down. <f> and <r> specifies the device fixed or removable. <x> exclude or include the device to boot. <Shift + 1> enables or disables a device. <1 - 4> loads default boot sequence.
F1 Help	↑↓ Select Item	+/- Change Values	F9 Setup Defaults
Esc Exit	↔ Select Menu	Enter Select ▶ Sub-Menu	F10 Save and Exit

The bootable devices will be automatically detected during POST and shown here, allowing you to set the sequence that the BIOS use to look for a boot device from which to load the operating system.

A brief description of keyboard usage is listed next:

Key	Function
↑, ↓	Selects (highlight) a boot device.
+, -	Changes the boot sequence.
1 to 4	Loads the four default boot sequence.
X	Moves the highlighted boot device from the “Boot priority order” list to the “Excluded from boot order” list, and vice versa.

<b>Key</b>	<b>Function</b>
<b>Shift + 1</b>	Deactivates/activates the highlighted boot device on the “Boot priority order” list. When a device has been deactivated, an “!” (exclamation) symbol appears beside the item and system will bypass it when detecting boot device during POST.

---

# Exit Menu

The Exit menu displays ways of exiting BIOS Setup Utility. After finishing with your settings, you must save and exit so that the changes can take effect.

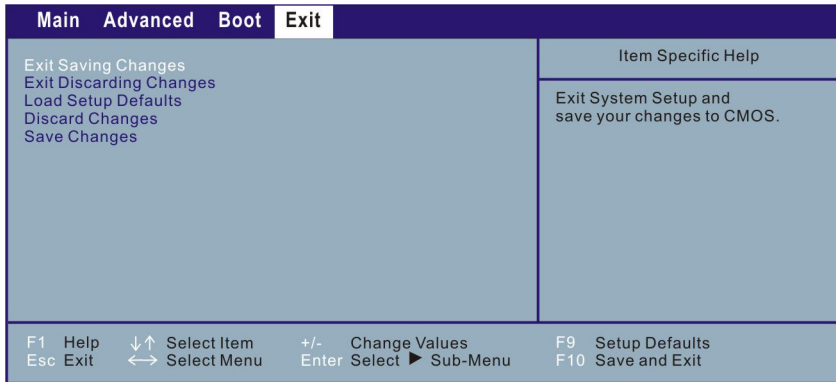

**Exit Saving Changes** saves the changes you have made and exits BIOS Setup Utility.

**Exit Discarding Changes** exits BIOS Setup Utility without saving the changes you have made.

**Load Setup Defaults** loads the factory default values for all the items.

**Discard Changes** restores the previous values for all the items.

**Save Changes** saves the changes you have made.

# ***Installing Software Drivers***

To take full advantage of the unique features of your computer, some operating systems require custom software, known as drivers, to be installed.

If you purchased the computer with Windows pre-installed, all the device drivers are pre-installed. All device drivers are also stored on the hard disk drive under directory called C:\UTILS for future reference.

Drivers can also be installed from the optional driver cd. For Latest driver visit <http://www.viglen.co.uk/>

This chapter describes how to install the drivers as well as using the P1 Quick Launch Key Utility.

# How to Use the Driver Disc

**NOTE:**

- The drivers may have been updated after this manual was published. For driver upgrade, please visit Viglen web site at :  
<http://www.viglen.co.uk/viglen/support/ftpnotebook.aspx>.
- 
- This disc supports Windows XP and Windows Vista.
- The available items may differ according to your computer model.
- Do not remove the driver disc when installing the driver.

To install the intended driver, click on the particular item and installation will start. The drivers are described next:

Name	Description
<b>Chipset</b>	Install the chipset first.
<b>VGA</b>	Installs the video driver that allows you to select high-resolution displays with richer colors.
<b>Audio</b>	Installs the audio driver that allows you to take full advantage of the audio subsystem.
<b>Modem</b> (Optional)	Installs the modem driver that allows you to use the modem function of the computer.
<b>LAN</b>	Installs the LAN driver that allows you to use the network function of the computer.
<b>Touchpad</b>	Installs the touchpad driver that allows you to take full advantage of the touchpad features.
<b>WLAN</b> (Optional)	Installs the WLAN driver and application program that allows you to use the computer's internal mini PCI-E WLAN card's network function. <b>NOTE:</b> The Windows Plug-and-Play capability may automatically detect the new device (mini PCI-E WLAN card) and display the wizard requesting for drivers. Click <b>Cancel</b> to bypass the wizard screen(s).
<b>CCD</b> (Optional)	Installs the web camera driver that allows you to use the computer's built-in camera function.
<b>ESB</b>	Installs the ESB driver that allows you to use the three Easy Start buttons to start three frequently-used programs.

# P1 Quick Launch Key Utility

The quick launch key utility allows you to define the “P1” quick launch key.

To start the utility, right-click the ESB icon  and select “Open” on the Windows system tray. The “ESB” window appears as shown next.

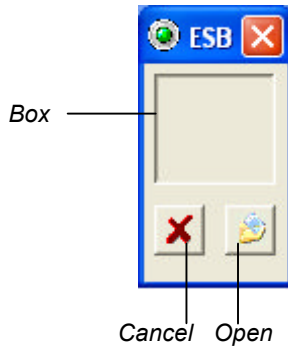



## Defining the buttons:

The box in the window represents the user-definable button.

To assign a program to a button, click the Open  icon under the box to pop up the **Select a File to Open** dialog box as shown next and select the desired program. Then, click **Open** to complete the process.

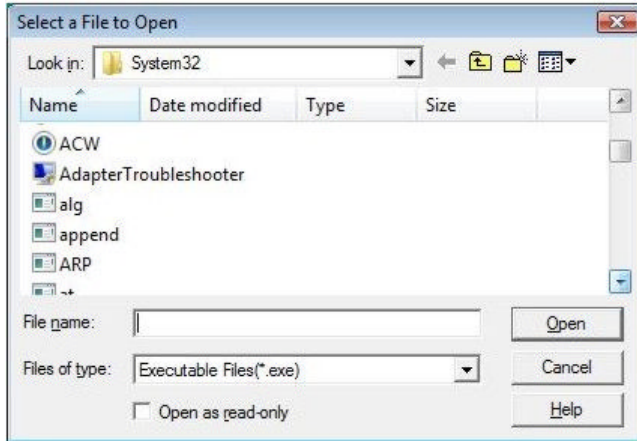

The appropriate icon will then appear in the box as shown next. To launch the program, press the **P1** quick launch key, or, if the **ESB** window is open, click the box containing the icon.



If you want to cancel the assignment of a program, click the Cancel  icon under the box.

# ***Caring for the Computer***

Taking good care of your computer will ensure a trouble-free operation and reduce the risk of damage to your computer.

This chapter gives you guidelines covering these areas of maintenance:

- How to protect the computer
- What to note when using and storing the computer
- How to clean the computer
- What to note when using the battery pack
- What to note when traveling with the computer

# Protecting the Computer

To safeguard the integrity of your computer data as well as the computer itself, you can protect the computer in several ways as described in this section.

## Using the Windows Security Center

Windows Security Center protects your computer against intrusion.

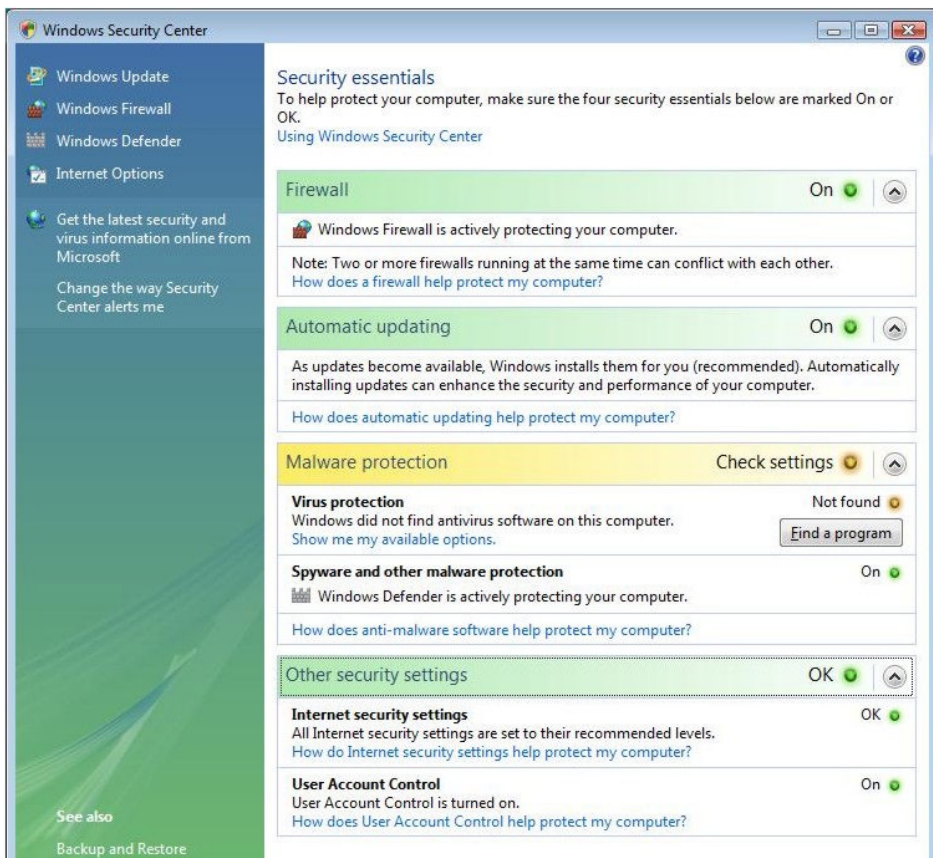

Windows Security Center alerts you to take action on the following security essentials:

- Windows Firewall
- Windows Update
- Malware Protection (anti-virus, anti-spyware)
- Others (Internet security, user account control)

For detailed information on Windows Security Center, see Windows' Help.

## Using the Cable Lock

You can use a Kensington-type cable lock to protect your computer against theft. The cable lock is available in most computer stores.

To use the lock, loop the lock cable around a stationary object such as a table. Insert the lock to the Kensington lock hole and turn the key to secure the lock. Store the key in a safe place.

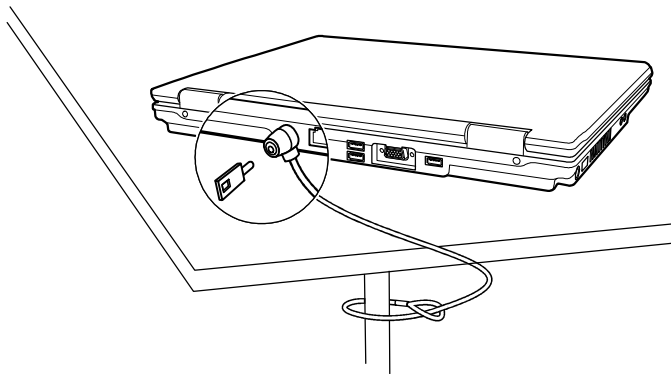

# Taking Care of the Computer

## Location Guidelines

- Use the computer where the temperature is between 10 °C (50 °F) and 35 °C (95 °F).
- Avoid placing the computer in a location subject to high humidity, extreme temperatures, mechanical vibration, direct sunlight, or heavy dust.
- Do not cover or block any ventilation openings on the computer. For example, do not place the computer on a bed, sofa, rug, or other similar surface. Otherwise, overheating may occur that results in damage to the computer.
- Keep the computer at least 13 cm (5 inches) away from electrical appliances that can generate a strong magnetic field such as a TV, refrigerator, motor, or a large audio speaker.
- Do not move the computer abruptly from a cold to a warm place. A temperature difference of more than 10 °C (18 °F) will cause condensation inside the unit, which may damage the storage media.
- Do not place the computer on an unsteady surface.

## General Guidelines

- Do not place heavy objects on top of the computer when it is closed as this may damage the display.
- The screen surface is easily scratched. Do not use paper towels to clean the display. Avoid touching it with your fingers, pen, or pencil.
- To maximize the life of the backlight in the display, allow the backlight to automatically turn off as a result of power management. Avoid using a screen saver or other software that prevents the power management from working.

## Cleaning Guidelines

- Never clean the computer with its power on.
- Use a soft cloth moistened with water or a non-alkaline detergent to wipe the exterior of the computer.
- Gently wipe the display with a soft, lint-free cloth. Do not use alcohol or detergent on the display.
- Dust or grease on the touchpad can affect its sensitivity. Clean the pad by using adhesive tape to remove the dust and grease on its surface.

## Battery Pack Guidelines

- Recharge the battery pack when it is nearly discharged. When recharging, make sure that the battery pack is fully charged. Doing so may avoid harm to the battery pack.
- Operate the computer with the battery pack installed even when using external power. This ensures that the battery is fully charged.
- If you will not be using the computer for a long period of time (more than two weeks), remove the battery pack from the computer.
- If you remove the battery pack, make sure that the battery terminals do not contact any conductors such as metal objects or water. Otherwise, the battery may become unusable as a result of a short circuit.
- If you need to store the battery pack, store it in a cool, dry place. Never allow the temperature to exceed 60 °C (140 °F).
- Do not leave the battery pack in storage for more than six months without recharging it.

# When Traveling

- Before traveling with your computer, make a backup of your hard disk data into flash disks or other storage devices. As an added precaution, bring along an extra copy of your important data.
- Make sure that the battery pack is fully charged.
- Make sure that the computer is turned off and the top cover is securely closed.
- Do not leave objects in between the keyboard and closed display.
- Disconnect the AC adapter from the computer and take it with you. Use the AC adapter as the power source and as a battery-charger.
- Hand-carry the computer. Do not check it in as luggage.
- If you need to leave the computer in the car, put it in the trunk of the car to avoid exposing the computer to excessive heat.
- When going through airport security, it is recommended that you send the computer and flash disks through the X-ray machine (the device you set your bags on). Avoid the magnetic detector (the device you walk through) or the magnetic wand (the handheld device used by security personnel).
- If you plan to travel abroad with your computer, consult your dealer for the appropriate AC power cord for use in your country of destination.

# *Troubleshooting*

Computer problems can be caused by hardware, software, or both. When you encounter any problem, it might be a typical problem that can easily be solved.

This chapter tells you what actions to take when solving common computer problems. It is divided into three sections:

- Preliminary checklist
- Solving common problems
- Resetting the computer



# Preliminary Checklist

Here are helpful hints to follow before you take further actions when you encounter any problem:

- Try to isolate which part of the computer is causing the problem.
- Make sure that you turn on all peripheral devices before turning on the computer.
- If an external device has a problem, make sure that the cable connections are correct and secure.
- Make sure that the configuration information is properly set in the BIOS Setup program.
- Make sure that all the device drivers are correctly installed.
- Make notes of your observations. Are there any messages on the screen? Do any indicators light? Do you hear any beeps? Detailed descriptions are useful to the service personnel when you need to consult one for assistance.

If any problem persists after you follow the instructions in this chapter, contact an authorized dealer for help.

# Solving Common Problems

For easy reference, the problems are divided into these categories.

<b>Problem Type</b>	<b>Go to</b>
Battery Problems	P. 8-4
DVD Drive Problems	P. 8-4
Display Problems	P. 8-5
ExpressCard Problems	P. 8-6
Hardware Device Problems	P. 8-6
Hard Disk Drive Problems	P. 8-7
Keyboard, Mouse, and Touchpad Problems	P. 8-7
LAN Problems	P. 8-8
WLAN Problems	P. 8-8
Modem Problems	P. 8-8
Power Management Problems	P. 8-10
Software Problems	P. 8-11
Sound Problems	P. 8-11
Startup Problems	P. 8-12
Other Problems	P. 8-13

# Battery Problems

**The battery does not charge (Battery Charge indicator does not light amber).**

- Make sure that the AC adapter is properly connected.
- Make sure that the battery is not too hot or cold. Allow time for the battery pack to return to room temperature.
- Make sure that the battery pack is installed correctly.
- Make sure that the battery terminals are clean.

**The operating time of a fully charged battery becomes shorter.**

- If you often partially recharge and discharge, the battery might not be charged to its full potential. Initialize the battery to solve the problem. (See “Initializing the Battery Pack” in Chapter 3 for instructions.)

**The battery operating time indicated by the battery meter does not match the actual operating time.**

- The actual operating time can be different from the estimated time, depending on how you are using the computer. If the actual operating time is much less than the estimated time, initialize the battery. (See “Initializing the Battery Pack” in Chapter 3 for instructions.)

# DVD Drive Problems

**The DVD drive cannot read a disc.**

- Make sure that the disc is correctly seated in the tray, with the label facing up.
- Make sure that the disc is not dirty. Clean the disc with a disc cleaning kit, available in most computer stores.
- Make sure that the DVD drive driver is installed correctly.
- Make sure that the computer supports the disc or the files contained.

### **You cannot eject a disc.**

- The disc is not properly seated in the drive. Manually release the disc following the method described next:
  1. Turn off the computer.
  2. Insert a small rod, such as a straightened paperclip, into the drive's manual eject hole and push firmly to release the tray.
  3. Pull the tray out until fully extended, and then remove the disc.

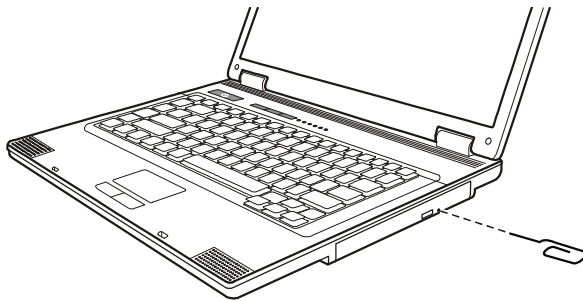

## Display Problems

### **Nothing appears on the screen.**

- During operation, the screen may automatically turn off as a result of power management. Press any key to see if the screen comes back.
- The brightness level might be too low. Increase brightness by pressing the **Fn+F7** hot key.
- The display output might be set to an external device. To switch the display back to the LCD, press the **Fn+F5** hot key or change the display through the settings in **Display Settings Properties**.

### **The characters on the screen are dim.**

- Adjust the brightness and/or contrast.

**Bad dots appear on the display at all times.**

- A small number of missing, discolored, or bright dots on the screen are an intrinsic characteristic of TFT LCD technology. It is not regarded as a LCD defect.

**Resolution cannot be adjusted to desired setting.**

- Make sure that the video driver is installed correctly.

**The external monitor displays nothing.**

- Make sure that the monitor is turned on.
- Make sure that the monitor's signal cable is properly connected.
- Switch the display to the monitor by pressing the **Fn+F5** hot key or change the display through the settings in **Display Settings** Properties.

**Simultaneous display/multi-display does not work.**

- Make sure that you turn on the external monitor before turning on the computer.
- Press the **Fn+F5** hot key to toggle through the display options or change the settings in **Display Settings** Properties in Windows.

## ExpressCard Problems

**The ExpressCard does not work.**

- Make sure that the ExpressCard is correctly seated.
- If the card requires an IRQ (Interrupt ReQuest), make sure that there is one available.

**The ExpressCard stops communicating properly.**

- The application may have been reset when the computer is turned off or in Sleep mode. Exit and restart the application.

# Hardware Device Problems

## **The computer does not recognize a newly installed device.**

- The device may not be correctly configured in the BIOS Setup program. Run the BIOS Setup program to identify the new type.
- Make sure if any device driver needs to be installed. (Refer to the documentation that came with the device.)
- Make sure if the device needs any jumper or switch settings. (Refer to the documentation that came with the device.)
- Check the cables or power cords for correct connections.
- For an external device that has its own power switch, make sure that the power is turned on.

# Hard Disk Drive Problems

## **The hard disk drive error message appears on the screen.**

- The hard disk drive has defects. Ask your dealer for help.

## **The hard disk drive operations seem slow.**

- The data files stored on the hard disk drive may be fragmented. Use a tool such as Window's **Disk Defragmenter** to defragment the files.

## **The hard disk drive in-use indicator glows without blinking.**

- The data files stored on the hard disk drive may be fragmented. Use a tool such as Window's **Disk Defragmenter** to defragment the files.

# Keyboard, Mouse, and Touchpad Problems

## **The keyboard does not respond.**

- Try connecting an external keyboard. If it works, contact an authorized dealer, as the internal keyboard cable might be loose.

**The numeric keypad is disabled.**

- Make sure that the **Num Lock** is switched on. (Check if the Num Lock Indicator  glows or not.)

**The external keyboard does not work.**

- Make sure that the keyboard cable is properly connected.

**The USB mouse does not work.**

- Make sure that the mouse cable is properly connected.

**The touchpad does not work, or the pointer is difficult to control with the touchpad.**

- Make sure that the touchpad driver is correctly installed.
- Make sure that the touchpad is clean.

## LAN Problems

**I cannot access the network.**

- Make sure that the LAN driver is correctly installed.
- Make sure that the LAN cable is properly connected to the RJ-45 connector and the network hub.
- Make sure that the network configuration is appropriate.
- Make sure that the user name or password is correct.

## WLAN Problems

**I cannot use the WLAN feature.**

- Make sure that the mini PCI-E WLAN card is correctly installed.
- Make sure that the necessary driver(s) is correctly installed.
- Make sure that the WLAN feature is turned on.

### **Transmission quality is poor.**

- Your computer may be in an out-of-range situation. Move your computer closer to the Access Point or another WLAN device it is associated with.
- Check if there is high interference around the environment and solve the problem as described next.

### **Radio interference exists.**

- Move your computer away from the device causing the radio interference such as microwave oven and large metal objects.
- Plug your computer into an outlet on a different branch circuit from that used by the affecting device.
- Consult your dealer or an experienced radio technician for help.

### **I cannot connect to another WLAN device.**

- Make sure that the WLAN feature is turned on.
- Make sure that the SSID setting is the same for every WLAN device in the network.
- Your computer is not recognizing changes. Restart the computer.
- Make sure that the IP address or subnet mask setting is correct.

### **I cannot communicate with the computer in the network when Infrastructure mode is configured.**

- Make sure that the Access Point your computer is associated with is powered on and all the LEDs are working properly.
- If the operating radio channel is in poor quality, change the Access Point and all the wireless station(s) within the BSSID to another radio channel.
- Your computer may be in an out-of-range situation. Move your computer closer to the Access Point it is associated with.
- Make sure that your computer is configured with the same security option (encryption) to the Access Point.



- Use the Web Manager/Telnet of the Access Point to check whether it is connected to the network.
- Reconfigure and reset the Access Point.

**I cannot access the network.**

- Make sure that the necessary driver(s) is correctly installed.
- Make sure that the network configuration is appropriate.
- Make sure that the user name or password is correct.
- You have moved out of range of the network.
- Turn off power management.

## Modem Problems

**The modem does not work.**

- Make sure that your model comes with the modem function.
- Make sure that the modem driver is correctly installed.
- Make sure that the telephone line is properly connected.
- Make sure that the COM port in the communication software is correctly set.
- Turn off power management.

## Power Management Problems

**The computer does not enter Sleep or Hibernation mode automatically.**

- If you have a connection to another computer, the computer does not enter Sleep or Hibernation mode if the connection is actively in use.
- Make sure that the Sleep or Hibernation time-out is enabled.

**The computer does not enter Sleep or Hibernation mode immediately.**

- If the computer is performing an operation, it normally waits for the operation to finish.

**The computer does not resume from Sleep or Hibernation mode.**

- The computer automatically enters Sleep or Hibernation mode when the battery pack is empty. Do any one of the following:
  - Connect the AC adapter to the computer.
  - Replace the empty battery pack with a fully charged one.

**The computer does not enter Sleep or Hibernation mode with the Fn+F12 hot keys.**

- Make sure that the Sleep or Hibernate function is specified for the sleep button.
- You might be using an ExpressCard that prevents the computer from entering Sleep mode. To enter the mode, stop the communication program and then remove the card or stop the card.

## Software Problems

**An application program does not work correctly.**

- Make sure that the software is correctly installed.
- If an error message appears on the screen, consult the software program's documentation for further information.
- If you are sure the operation has stop, reset the computer. (See "Resetting the Computer" later in this chapter.)

## Sound Problems

**No sound is produced.**

- Make sure that the volume control is not set too low.

- Make sure that the audio driver is correctly installed.
- Make sure that the computer is not in Sleep mode.
- If using an external speaker, make sure that the speaker is properly connected.

**Distorted sound is produced.**

- Make sure that the volume control is not set too high or too low. In most cases, a high setting can cause the audio electronics to distort the sound.

**The sound system does not record.**

- Adjust the playback or recording sound levels.

**The external microphone or audio device does not work.**

- Make sure that the microphone is connected to the proper connector on the computer.
- Make sure that your computer is equipped with the driver needed.
- Click the speaker symbol on the system tray and check the Windows volume control.
- Check the volume control of your computer.

## Startup Problems

**When you turn on the computer, it does not respond and the Power Status Indicator does not light green.**

- If you are using an external AC power, make sure that the AC adapter is correctly and securely connected. If so, make sure that the electrical outlet works properly.
- If you are using the battery power, make sure that the battery is not discharged.

**When you turn on the computer, it stops after POST.**

- Restart your computer.

**The message “Operating system not found” appears on the screen after you turn on the computer.**

- If this message appears when you are booting from the hard disk, insert a bootable disc in the DVD drive and check the condition of the hard disk.

**The message “Invalid system disk” or “Disk error” appears on the screen after you turn on the computer.**

- If you are deliberately trying to boot from a disc, replace the disc with a bootable one and press any key to continue booting.
- If this message appears when you are booting from the hard disk, insert a bootable disc in the DVD drive and check the condition of the hard disk.

## Other Problems

**The date/time is incorrect.**

- Correct the date and time via the operating system or BIOS Setup program.
- After you have performed everything as described above and still have the incorrect date and time every time you turn on the computer, the RTC (Real-Time Clock) battery is at the end of its life. Call an authorized dealer to replace the RTC battery.

# Resetting the Computer

You may have to reset (reboot) your computer on some occasions when an error occurs and the program you are using hangs up.

If the computer operation seems to hang up, first wait. It is possible that the computer is processing data. Periodically check the hard disk drive in-use indicator, if it flashes irregularly, the program may be accessing data and preventing you from using the keyboard. If you are sure the operation has stopped and you cannot use the “restart” function of the operating system, reset the computer.

Reset the computer by any one of these methods:

- Press **Ctrl+Alt+Del**.
- If the above action does not work, turn off the computer. Wait for at least five seconds and turn it on again.

**| CAUTION:** Resetting will cause any unsaved data to be lost.

# Specifications

**| NOTE:** Specifications are subject to change without any prior notice.

Parts		Specifications
CPU		Intel® Pentium-M / Celeron-M processor (Santa Rosa Merom core), 667 MHz FSB (Front Side Bus)
ROM BIOS		512 KB EEPROM
RAM	System	2 × 200-pin DDRII 667 MHz SO-DIMM sockets 1.25-inch height
Display	Panel	15.4-inch TFT, resolution up to 1280×800 WXGA
	Video controller	UMA
	Video ports	VGA port
	Video memory	64 MB shared system memory (default), supports up to 256 MB
Audio	Controller	Azalia
	Ports	Two audio ports for Line-out / Mic-in
	Speakers	1 W stereo × 2
Keyboard		Standard keys, numeric keypad, 12 function keys, a special <b>Fn</b> (Function) key and Windows keys
Pointing device		PS/2-compatible touchpad with two buttons
Storage device	Hard disk drive	SATA interface 2.5-inch diameter (9.5 mm height), 4200/5400 RPM
	Optical drive	Combo/DVD Dual/Super Multi (12.7 mm height)
ExpressCard/54		Type II ExpressCard/34 / ExpressCard/54 support
I/O ports		Four USB 2.0 ports, RJ-11 port, RJ-45 port
Modem (Optional)		56 Kbps V.90 MDC internal fax modem, Azalia interface
LAN		10/100 Mbps
Wireless LAN (Optional)		One mini PCI-E slot for wireless LAN card, compliant with IEEE 802.11a/b/g or 802.11b/g (pre-installed in selected models)
Power	AC adapter	Universal AC adapter 65 W; Input 100-240 V, Output 19 V
	Battery	4-cell Li-ion battery 2200 mAh / 14.8 V 6-cell Li-ion battery 4400 mAh / 11.1 V

Parts		Specifications
Dimension (W×D×H)		358×263×20~36.6 mm (14.1×10.4×0.8~1.4 inch)
Weight		2.9 kg (6.4 lb)
Environment	Temperature	Operating: 0 °C (32 °F) to 35 °C (95 °F) Storage: -20 °C (-4 °F) to 60 °C (140 °F)
	Humidity	Operating: 10 % to 90 % non-condensing Storage: 5 % to 95 % non-condensing
Regulation	EMC	CE
	Safety	CB
Green Product Coverage	RoHS	6 European Union RoHS banned materials
	Others	12 universal GP product banned materials

# *Regulatory Information*

This appendix provides regulatory statements and safety notices on your computer.

**NOTE:** Marking labels located on the exterior of your computer indicate the regulations that your model complies with. Please check the marking labels and refer to the corresponding statements in this appendix. Some notices apply to specific models only.



# On the Use of the System

## Class B Regulations

### USA

#### Federal Communications Commission Radio Frequency Interference Statement

**NOTE:**

This equipment has been tested and found to comply with the limits for a Class B digital device pursuant to Part 15 of the FCC Rules. These limits are designed to provide reasonable protection against harmful interference in a residential installation. This equipment generates, uses, and can radiate radio frequency energy and, if not installed and used in accordance with the instructions, may cause harmful interference to radio communications. However, there is no guarantee that interference will not occur in a particular installation. If this equipment does cause harmful interference to radio or television reception, which can be determined by turning the equipment off and on, the user is encouraged to try to correct the interference by one or more of the following measures:

- Reorient or relocate the receiving antenna.
- Increase the separation between the equipment and receiver.
- Connect the equipment into an outlet on a circuit different from that to which the receiver is connected.
- Consult the dealer or an experienced radio/TV technician for help.

Any changes or modifications not expressly approved by the manufacturer could void the user's authority to operate the equipment.

**Please note:**

The use of a non-shielded interface cable with this equipment is prohibited.

# Canada

## Canadian Department of Communications Radio Interference Regulations Class B Compliance Notice

This Class B digital apparatus meets all requirements of the Canada Interference-Causing equipment regulations.

Cet appareil numérique de Classe B respecte toutes les exigences du Règlement Canadien sur le matériel brouilleur.

This digital apparatus does not exceed the Class B limits for radio noise emissions from digital apparatus set out in the Radio Interference Regulations of the Canadian Department of Communications.

Le présent appareil numérique n'émet pas de bruits radioélectriques dépassant les limites applicables aux appareils numériques de la classe B prescrites dans le Règlement sur le brouillage radioélectrique édicté par le ministère des Communications du Canada.

## Safety Notices

### About the Battery

#### Caution Texts Concerning Lithium Batteries

##### **DANISH**

ADVARSEL! Lithiumbatteri – Eksplosionsfare ved fejlagtig håndtering. Udskiftning må kun ske med batteri af samme fabrikat og type. Levér det brugte batteri tilbage til leverandøren.

##### **NORWEGIAN**

ADVARSEL: Eksplosjonsfare ved feilaktig skifte av batteri. Benytt samme batteritype eller en tilsvarende type anbefalt av apparatfabrikanten. Brukte batterier kasseres i henhold til fabrikantens instruksjoner.

##### **SWEDISH**

VARNING: Explosionsfara vid felaktigt batteribyte. Använd samma batterityp eller en ekvivalent typ som rekommenderas av apparattillverkaren. Kassera använt batteri enligt fabrikantens instruktion.

##### **FINNISH**

VAROITUS: Paristo voi räjähtää, jos se on virheellisesti asennettu. Vaihda paristo ainoastaan valmistajan suosittelemaan tyyppiin. Hävitä käytetty paristo valmistajan ohjeiden mukaisesti.

**ENGLISH**

**CAUTION:** Danger of explosion if battery is incorrectly replaced. Replace only with the same or equivalent type recommended by the equipment manufacturer. Discard used batteries according to manufacturer's instructions.

**DEUTSCH**

**VORSICHT:** Explosionsgefahr bei unsachgemäßem Austausch der Batterie. Ersatz nur durch denselben oder einen vom Hersteller empfohlenen gleich-wertigen Typ. Entsorgung gebrauchter Batterien nach Angaben des Herstellers.

**FRENCH**

**ATTENTION:** Il y a danger d'explosion s'il y a remplacement incorrect de la batterie. Remplacer uniquement avec une batterie du même type ou d'un type équivalent recommandé par le constructeur. Mettre au rebut les batteries usagées conformément aux instructions du fabricant.

**Attention (for USA Users)**

The product that you have purchased contains a rechargeable battery. The battery is recyclable. At the end of its useful life, under various state and local laws, it may be illegal to dispose of this battery into the municipal waste stream. Check with your local solid waste officials for details in your area for recycling options or proper disposal.

**About the AC Adapter**

- Use only the AC adapter supplied with your computer. Use of another type of AC adapter will result in malfunction and/or danger.
- Do not use the adapter in a high moisture environment. Never touch the adapter when your hands or feet are wet.
- Allow adequate ventilation around the adapter when using it to operate the device or charge the battery. Do not cover the AC adapter with paper or other objects that will reduce cooling. Do not use the AC adapter while it is inside a carrying case.
- Connect the adapter to a proper power source. The voltage requirements are found on the product case and/or packaging.
- Do not use the adapter if the cord becomes damaged.
- Do not attempt to service the unit. There are no serviceable parts inside. Replace the unit if it is damaged or exposed to excess moisture.

## About the Modem

### Caution

- Never install telephone wiring during a lightning storm.
- Never install telephone jacks in wet locations unless the jack is specifically designed for wet locations.
- Never touch non-insulated telephone wires or terminals unless the telephone line has been disconnected at the network interface.
- Use caution when installing or modifying telephone lines.
- Avoid using the telephone function (other than a cordless type) during an electrical storm. There may be a remote risk of electric shock from lightning.
- Do not use the telephone function to report a gas leak in the vicinity of the leak.
- Do not use this product near water, for example near a bathtub, wash bowl, kitchen sink or laundry tub, in a wet basement or near a swimming pool.

### Caution (for USA Users)

To reduce the risk of fire, use only No.26 AWG or larger telecommunication line cord.

# On the Use of the RF Device

| **NOTE:** The information in this section applies to models with the wireless LAN module.

## USA and Canada Safety Requirements and Notices

**IMPORTANT NOTE:** To comply with FCC RF exposure compliance requirements, the antenna used for this transmitter must be installed to provide a separation distance of at least 20 cm from all persons and must not be co-located or operating in conjunction with any other antenna or transmitter.

## Radio Frequency Interference Requirements and SAR

The FCC with its action in ET Docket 93-62 has adopted a safety standard for human exposure to Radio Frequency (RF) electromagnetic energy emitted by FCC certified equipment. The wireless LAN module meets the Human Exposure limits found in OET Bulletin 65, 2001, and ANSI/IEEE C95.1, 1992. Proper operation of this radio according to the instructions found in this manual will result in exposure substantially below the FCC's recommended limits. The following safety precautions should be observed:

- Do not touch or move antenna while the unit is transmitting or receiving.
- Do not hold any component containing the radio such that the antenna is very close or touching any exposed parts of the body, especially the face or eyes, while transmitting.
- Do not operate the radio or attempt to transmit data unless the antenna is connected; if not, the radio may be damaged.

### Use in specific environments:

- The use of wireless devices in hazardous locations is limited by the constraints posed by the safety directors of such environments.

- The use of wireless devices on airplanes is governed by the Federal Aviation Administration (FAA).
- The use of wireless devices in hospitals is restricted to the limits set forth by each hospital.

### Antenna use:

- In order to comply with FCC RF exposure limits, low gain integrated antennas should be located at a minimum distance of 20 cm (8 inches) or more from the body of all persons.
- High-gain, wall-mount, or mast-mount antennas are designed to be professionally installed and should be located at a minimum distance of 30 cm (12 inches) or more from the body of all persons. Please contact your professional installer, VAR, or antenna manufacturer for proper installation requirements.

### Explosive Device Proximity Warning

**WARNING:** Do not operate a portable transmitter (such as a wireless network device) near unshielded blasting caps or in an explosive environment unless the device has been modified to be qualified for such use.

### Antenna Warning

**WARNING:** To comply with the FCC and ANSI C95.1 RF exposure limits, it is recommended that the antenna for this device be installed so as to provide a separation distance of at least 20 cm (8 inches) from all persons and that the antenna must not be co-located or operating in conjunction with any other antenna or radio transmitter. It is recommended that the user limit exposure time if the antenna is positioned closer than 20 cm (8 inches).

### Use on Aircraft Caution

**CAUTION:** Regulations of the FCC and FAA prohibit airborne operation of radio-frequency wireless devices because their signals could interfere with critical aircraft instruments.

## EMC Requirements

This device uses, generates and radiates radio frequency energy. The radio frequency energy produced by this device is well below the maximum exposure allowed by the Federal Communications Commission (FCC).

This device complies with the limits for a Class B digital device pursuant to Part 15 subpart C of the FCC Rules and Regulations. Operation is subject to the following two conditions:

- (1) This device may not cause harmful interference.
- (2) This device must accept any interference received, including interference that may cause undesired operation.

The FCC limits are designed to provide reasonable protection against harmful interference when the equipment is installed and used in accordance with the instruction manual and operated in a commercial environment. However, there is no guarantee that interference will not occur in a particular commercial installation, or if operated in a residential area.

If harmful interference with radio or television reception occurs when the device is turned on, the user must correct the situation at the user's own expense. The user is encouraged to try one or more of the following corrective measures:

- Reorient or relocate the receiving antenna.
- Increase the separation between the equipment and receiver.
- Connect the equipment into an outlet on a circuit different from that to which the receiver is connected.
- Consult the dealer or an experienced radio/TV technician for help.

**CAUTION:** The Part 15 radio device operates on a non-interference basis with other devices operating at this frequency. Any changes or modification to said product not expressly approved by the manufacturer could void the user's authority to operate this device.

## Canada Radio Frequency Interference Requirements

To prevent radio interference to the licensed service, this device is intended to be operated indoors and away from windows to provide maximum shielding. Equipment (or its transmit antenna) that is installed outdoors is subject to licensing.

Pour empêcher que cet appareil cause du brouillage au service faisant l'objet d'une licence, il doit être utilisé à l'intérieur et devrait être placé loin des fenêtres afin de fournir un écran de blindage maximal. Si le matériel (ou son antenne d'émission) est installé à l'extérieur, il doit faire l'objet d'une licence.

## European Union CE Marking and Compliance Notices

### Statements of Compliance

#### **English**

This product follows the provisions of the European Directive 1999/5/EC.

#### **Danish**

Dette produkt er i overensstemmelse med det europæiske direktiv 1999/5/EC.

#### **Dutch**

Dit product is in navolging van de bepalingen van Europees Directief 1999/5/EC.

#### **Finnish**

Tämä tuote noudattaa EU-direktiivin 1999/5/EC määräyksiä.

#### **French**

Ce produit est conforme aux exigences de la Directive Européenne 1999/5/EC.

#### **German**

Dieses Produkt entspricht den Bestimmungen der Europäischen Richtlinie 1999/5/EC.



### **Greek**

Το προϊόν αυτό πληροί τις προβλέψεις της Ευρωπαϊκής Οδηγίας 1999/5/EC.

### **Icelandic**

Þessi vara stendst reglugerð Evrópska Efnahags Bandalagsins númer 1999/5/EC.

### **Italian**

Questo prodotto è conforme alla Direttiva Europea 1999/5/EC.

### **Norwegian**

Dette produktet er i henhold til bestemmelsene i det europeiske direktivet 1999/5/EC.

### **Portuguese**

Este produto cumpre com as normas da Diretiva Europeia 1999/5/EC.

### **Spanish**

Este producto cumple con las normas del Directivo Europeo 1999/5/EC.

### **Swedish**

Denna produkt har tillverkats i enlighet med EG-direktiv 1999/5/EC.

## **Local Restrictions of 802.11a/b/g Radio Usage**

**802.11a wireless LAN devices:** For operation within 5.15 ~ 5.25 GHz frequency range, it is restricted to indoor usage environments, and the antenna of this device must be integral.

**CAUTION:** Due to the fact that the frequencies used by 802.11a/b/g wireless LAN devices may not yet be harmonized in all countries, 802.11a/b/g products are designed for use only in specific countries or regions, and is not allowed to be operated in countries or regions other than those of designated use. As a user of these products, you are responsible for ensuring that the products are used only in the countries or regions for which they were intended and for verifying that they are configured with the correct selection of frequency and channel for the country or region of use. Any deviation from permissible settings and restrictions in the country or region of use could be an infringement of local law and may be punished as such.

The European variant is intended for use throughout the European Economic Area. However, authorization for use is further restricted in particular countries or regions within countries, as follows:

## General

European standards dictate maximum radiated transmit power of 100 mW Effective Isotropic Radiated Power (EIRP) and the frequency range 2400 – 2483.5 MHz.

## Belgium and the Netherlands

In Belgium and the Netherlands, the product may not be used outdoors. See the instructions next under the heading “Turning Off the Wireless LAN Radio.”

## France

### **Departments in Which the Wireless LAN Module Can Be Used (Indoors Only)**

The wireless LAN module can currently be used indoors only in the following 38 departments of mainland France. Please turn off your wireless LAN radio when operating the device in areas/places other than the 38 departments listed:

01	Ain Orientales	36	Indre	66	Pyrénées
02	Aisne	37	Indre et Loire	67	Bas Rhin
03	Allier	41	Loir et Cher	68	Haut Rhin
05	Hautes Alpes	42	Loire	70	Haute Saône
08	Ardennes	45	Loiret	71	Saône et Loire
09	Ariège	50	Manche	75	Paris
11	Aude	55	Meuse	82	Tarn et Garonne
12	Aveyron	58	Nièvre	84	Vaucluse
16	Charente	59	Nord	88	Vosges
24	Dordogne	60	Oise	89	Yonne
25	Doubs	61	Orne	90	Territoire de Belfort
26	Drôme	63	Puy du Dôme	94	Val de Marne
32	Gers	64	Pyrénées Atlantique		

**Departments in Which the Wireless LAN Module’s Maximum EIRP Not Shown in the Previous Table**

<b>Frequency Ranges (MHz)</b>	<b>Indoors</b>	<b>Outdoors</b>
2400 – 2446.5	10 mW	Not permitted
2446.5 – 2483.5	100 mW	100 mW on private property with Ministry of Defense approval

## Turning Off the Wireless LAN Radio

**NOTE:** Turning the wireless LAN radio off is not the same as disabling the wireless LAN card. It is not necessary to disable the card to meet the regulatory requirements.

While operating the computer in those French departments that do not allow use of the wireless LAN equipment, the user of the equipment must turn off the wireless LAN radio in order to comply with local regulations (see “Turning Off/On the WLAN Radio” in Chapter 2 for more information).

# 电子信息产品有毒有害物质或元素名称及含量标示

项目	部件名称	有毒有害物质或元素					
		铅 (Pb)	镉 (Cd)	汞 (Hg)	六价铬 (Cr+6)	多溴联苯 (PBB)	多溴二苯醚 (PBDE)
1	金属机构件	X	O	O	O	O	O
2	塑料机构件	O	O	O	O	O	O
3	电路板组件	X	X	O	O	O	O
4	液晶面板	X	X	X	O	O	O
5	硬盘	X	O	O	O	O	O
6	光驱	X	O	O	O	O	O
7	键盘	X	O	O	O	O	O
8	充电电池组件	X	X	O	O	O	O
9	适配器	X	X	X	O	O	O
10	电源线	X	O	O	O	O	O
11	外部信号连接线	O	O	O	O	O	O
12	钮扣电池	O	O	X	O	O	O
13	风扇	X	O	O	O	O	O
14	散热模块 (金属部分)	X	O	O	O	O	O
15	喇叭	X	O	O	O	O	O

O: 表示该有害物质在该部件所有均质材料中的含量均在 SJ/T 11363-2006 规定的限量要求以下。

X: 表示该有害物质至少在该部件的某一均质材料中的含量超出 SJ/T 11363-2006 规定的限量要求。

(本产品使用技术无法突破之 EU RoHS 除外项目, 并于下方使用项目说明)。

使用除外项目如下：

1. 铅使用于部件、装置的内部连接用高熔点锡焊上（铅为 85wt% 以上的有铅锡焊）。
2. 电子陶瓷部件（压电组件·陶瓷介质材料等）内的含铅量。
3. 电子部件的玻璃内的含铅量。
4. 两种以上元素组成之焊料，用于连接微处理器封装与针头且铅含量超过 80wt% 并少于 85wt%。
5. 铅于覆晶集成电路封装内用于铸模与基板之电子接点之焊锡。
6. 于钢材、铝材、铜材中的含铅量。
7. 通孔盘状及平面数组陶瓷多层电容器焊料所含的铅。
8. 电子接点的电镀，其要求高可靠性，且没有替代性材料之镉。
9. 电池内的含铅量。
10. 电池内的含镉量。
11. 使用于钮扣电池之含汞量。

# Index

## —A—

- AC adapter, 3-2
  - Connecting, 1-2
  - Safety notices, B-4
  - Specification, A-1
- AC power
  - Connecting, 1-2
- ACPI, 3-8
- Adobe Acrobat Reader, 6-4
- Alt key, 2-7
- Antenna
  - Safety notices, B-7
- Anti-Virus, 7-3
- Audio connector, 2-19
- Audio driver, 6-4
- Audio output connector, 1-7, 2-20
- Audio subsystem
  - Connecting external audio device, 2-20
  - Driver installation, 6-4
  - Feature, 2-19
  - Troubleshooting, 8-11

## —B—

- Backspace key, 2-7
- Battery
  - Indicator, 3-3
- Battery charge
  - Indicator, 1-11
- Battery low, 3-7
  - Warning beep, 5-6

- Battery pack, 1-9
  - Battery low, 3-7
  - Charging, 3-3
  - Checking battery level, 3-5
  - Initializing, 3-4
  - Replacing, 3-5
  - Safety notices, B-3
  - Specification, A-1
  - Taking care, 7-5
  - Troubleshooting, 8-4
- BIOS Setup, 5-1
  - Boot device, 5-9
  - Date and time setting, 5-5
  - Exiting, 5-10
  - Starting, 5-2
- Boot sequence, 5-9
- Booting, 2-2
- Brightness
  - Hot key, 2-12

## —C—

- Caps Lock, 2-8
  - Indicator, 1-11
- CD. *See* DVD drive
- Charging, 3-3
- Chipset driver, 6-4
- Class 1 laser product, 2-16
- Class B regulations
  - Canada, B-3
  - USA, B-2
- Cleaning the computer, 7-5
- Click, 2-14
- Combo drive. *See* DVD drive

- Connecting external device
  - Monitor, 4-2
  - USB device, 4-3
- Connector
  - Audio output, 1-7, 2-20
  - Microphone, 1-7, 2-20
- Copyright protection
  - Macrovision Corp., 2-17
- Cover
  - Latch, 1-10
  - Opening, 1-4
- CPU, 1-9
  - Specification, A-1
- Ctrl key, 2-7
- Cursor, 2-8
- Cursor-control key, 2-8

## —D—

- Date, 5-5, 8-13
- DC, 3-2
- Dimension of the computer, A-2
- Display
  - Switching on and off with hot key, 2-12
  - Troubleshooting, 8-5
- Display mode, 2-18
- Display output
  - Hot key, 2-12
- Double-click, 2-14
- Drag and drop, 2-14
- Drive D, 2-16
- Driver installation, 6-1
- Driver OS support, 6-2
- DVD drive, 1-6, 2-16
  - Inserting a disc, 2-17
  - In-use indicator, 1-11
  - Troubleshooting, 8-4
- DVD Dual drive. *See* DVD drive

## —E—

- Easy Start button
  - Defining the button, 2-6
  - Driver installation, 6-4
  - Internet Explorer, 1-10, 2-4

- Microsoft Outlook, 1-10, 2-4
  - P1, 1-10, 2-4
- EEPROM, A-1
- EMC requirements, B-8
- Environmental specifications, A-2
- ESB. *See* Easy Start button
- Esc key, 2-7
- Euro symbol, 2-10
- European Union
  - Compliance notices, B-9
- ExpressCard
  - Inserting, 4-5
  - Removing, 4-5
  - Slot, 1-7
  - Troubleshooting, 8-6
  - Type, 4-4
- External monitor
  - Connecting, 4-2

## —F—

- FDA regulations, 2-16
- Fn key, 2-11
- Function key, 2-11

## —H—

- Hard disk drive
  - Compartment, 1-9
  - In-use indicator, 1-11
  - Troubleshooting, 8-7
- Hibernation, 2-3, 3-8, 3-9
  - Troubleshooting, 8-10
- Hot key, 2-12
- Humidity, A-2

## —|—

- Indicator
  - Battery charge, 1-11, 3-3
  - Caps Lock, 1-11
  - DVD drive, 1-11
  - Hard disk drive, 1-11
  - Num Lock, 1-11

Power status, 1-11  
WLAN, 1-11

## —K—

Kensington lock, 1-8, 7-2  
Keyboard, 1-11, 2-7  
    Troubleshooting, 8-7

## —L—

LAN, 2-22  
    Connector, 1-8  
    Driver installation, 6-4  
    Troubleshooting, 8-8  
LCD, 1-10, 2-18  
    Specification, A-1  
Location of the computer, 7-4  
Low battery. *See* Battery low

## —M—

Memory  
    Video, 5-6  
Memory module, 1-9  
Microphone connector, 1-7, 2-20  
Modem, 2-21  
    Driver installation, 6-4  
    Safety notices, B-5  
    Troubleshooting, 8-10  
Mouse  
    Troubleshooting, 8-7  
Mute, 2-12

## —N—

Network. *See* LAN  
Num Lock, 2-8  
    Indicator, 1-11  
Numeric key, 2-10

## —O—

Operating system, 1-5, 2-2

## —P—

Password, 5-8  
Pause key, 2-8  
Point, 2-14  
POST, 1-5  
    Beep sound, 5-6  
Power button, 1-11, 2-2  
Power connector, 1-7  
Power Management, 3-8  
    Troubleshooting, 8-10  
Power status  
    Indicator, 1-11  
Power-On Self Test. *See* POST  
Print Screen key, 2-8

## —R—

RAM, A-1  
Rebooting, 8-14  
Regulatory information, B-1  
Resetting, 8-14  
Restarting, 8-14  
RJ-11, 1-8, 2-21  
RJ-45, 1-8, 2-22  
ROM BIOS, A-1

## —S—

Saving power, 3-10  
Screen. *See* LCD  
Scroll, 2-14  
Scroll Lock, 2-8  
Security  
    Protecting the computer with lock, 7-2  
    Windows Security Center, 7-2  
Shift key, 2-7  
Shutting down, 1-5, 2-2



- Sleep, 2-2, 3-8
  - Troubleshooting, 8-10
- Sleep button, 2-12
- Software
  - Troubleshooting, 8-11
- Software driver, 6-1
- Speaker, 1-11, 2-19
  - Connecting external speakers, 2-20
- Specifications, A-1
- Startup, 2-2
  - Troubleshooting, 8-12
- Super Multi drive. *See* DVD drive

## —T—

- Telephone line
  - Connecting, 2-21
  - Connector, 1-8
- Temperature, A-2
- TFT, 2-18
- Time, 5-5, 8-13
- Touchpad, 1-11, 2-13
  - Configuring, 2-15
  - Driver installation, 6-4
  - Troubleshooting, 8-7
- Traveling with the computer, 7-6
- Troubleshooting, 8-1
  - Battery problem, 8-4
  - Display problem, 8-5
  - DVD drive problem, 8-4
  - ExpressCard problem, 8-6
  - Hard disk drive problem, 8-7
  - Hardware problem, 8-7
  - Keyboard problem, 8-7
  - LAN problem, 8-8
  - Modem problem, 8-10
  - Mouse problem, 8-7
  - Other problem, 8-13
  - Power Management problem, 8-10
  - Software problem, 8-11
  - Sound problem, 8-11
  - Startup problem, 8-12
  - Touchpad problem, 8-7
  - WLAN problem, 8-8
- Turning off, 1-5, 2-2
- Turning on, 1-4

- Typewriter key, 2-7

## —U—

- Upgrading the computer, 4-6
- USB device
  - Connecting, 4-3
- USB port, 1-7, 1-8, 4-3

## —V—

- VGA port, 1-8, 4-2
- Video driver, 6-4
- Video memory, 5-6
- Video subsystem
  - Configuring, 2-18
  - Driver installation, 6-4
  - Feature, 2-18
  - Video controller, A-1
- Virus, 7-3
- Volume
  - Hot key, 2-12

## —W—

- Weight of the computer, A-2
- Windows, 1-5
- Windows key, 2-11
- WLAN
  - BIOS Setup, 5-7
  - Driver installation, 6-4
  - France restrictions, B-11
  - Hot key, 2-12
  - Indicator, 1-11
  - Local restrictions, B-10
  - Safety notices, B-6
  - Troubleshooting, 8-8
  - Turning off, 2-24
  - Turning on, 2-24
  - Using, 2-23
- WLAN network
  - Configuring, 2-25

