

USER'S MANUAL

notebook



Notice

The company reserves the right to revise this publication or to change its contents without notice. Information contained herein is for reference only and does not constitute a commitment on the part of the manufacturer or any subsequent vendor. They assume no responsibility or liability for any errors or inaccuracies that may appear in this publication nor are they in anyway responsible for any loss or damage resulting from the use (or misuse) of this publication.

This publication and any accompanying software may not, in whole or in part, be reproduced, translated, transmitted or reduced to any machine readable form without prior consent from the vendor, manufacturer or creators of this publication, except for copies kept by the user for backup purposes.

Brand and product names mentioned in this publication may or may not be copyrights and/or registered trademarks of their respective companies. They are mentioned for identification purposes only and are not intended as an endorsement of that product or its manufacturer.

©June 2005

Trademarks

This product incorporates copyright protection technology that is protected by method claims of certain U.S. patents and other intellectual property rights owned by Macrovision Corporation and other rights owners. Use of this copyright protection technology must be authorized by Macrovision Corporation, and is intended for home or other limited viewing uses only unless otherwise authorized by Macrovision Corporation. Reverse engineering or disassembly is prohibited.

Intel®, **Pentium®** and **Celeron®** are US registered trademarks of Intel Corporation.

FCC Statement (Federal Communications Commission)

This equipment has been tested and found to comply with the limits for a Class B digital device, pursuant to Part 15 of the FCC Rules. These limits are designed to provide reasonable protection against harmful interference in a residential installation. This equipment generates, uses and can radiate radio frequency energy and, if not installed and used in accordance with the instructions, may cause harmful interference to radio communications. However, there is no guarantee that interference will not occur in a particular installation. If this equipment does cause harmful interference to radio or television reception, which can be determined by turning the equipment off and on, the user is encouraged to try to correct the interference by one or more of the following measures:

- Re orient or relocate the receiving antenna.
- Increase the separation between the equipment and receiver.
- Connect the equipment into an outlet on a circuit different from that to which the receiver is connected.
- Consult the service representative or an experienced radio/TV technician for help.



Warning

Use only shielded cables to connect I/O devices to this equipment. You are cautioned that changes or modifications not expressly approved by the manufacturer for compliance with the above standards could void your authority to operate the equipment.

IMPORTANT SAFETY INSTRUCTIONS

Follow basic safety precautions, including those listed below, to reduce the risk of fire, electric shock, and injury to persons when using any electrical equipment:

1. Do not use this product near water, for example near a bath tub, wash bowl, kitchen sink or laundry tub, in a wet basement or near a swimming pool.
2. Avoid using this equipment with a telephone line (other than a cordless type) during an electrical storm. There may be a remote risk of electrical shock from lightning.
3. Do not use the telephone to report a gas leak in the vicinity of the leak.
4. Use only the power cord and batteries indicated in this manual. Do not dispose of batteries in a fire. They may explode. Check with local codes for possible special disposal instructions.
5. This product is intended to be supplied by a Listed Power Unit (DC Output 20V, 3.25A (**65W**) minimum AC/DC Adapter, **OR** by a DC Output 20V, 4.5A (**90W**) minimum AC/DC Adapter if you are using the **optional port replicator**- see pages **7 - 12** & **C - 5**).

CAUTION

Always disconnect all telephone lines from the wall outlet before servicing or disassembling this equipment.

**TO REDUCE THE RISK OF FIRE, USE ONLY NO. 26 AWG OR LARGER,
TELECOMMUNICATION LINE CORD**

This Computer's Optical Device is a Laser Class I Product

Instructions for Care and Operation

The notebook computer is quite rugged, but it can be damaged. To prevent this, follow these suggestions:





1. **Don't drop it, or expose it to shock.** If the computer falls, the case and the components could be damaged.

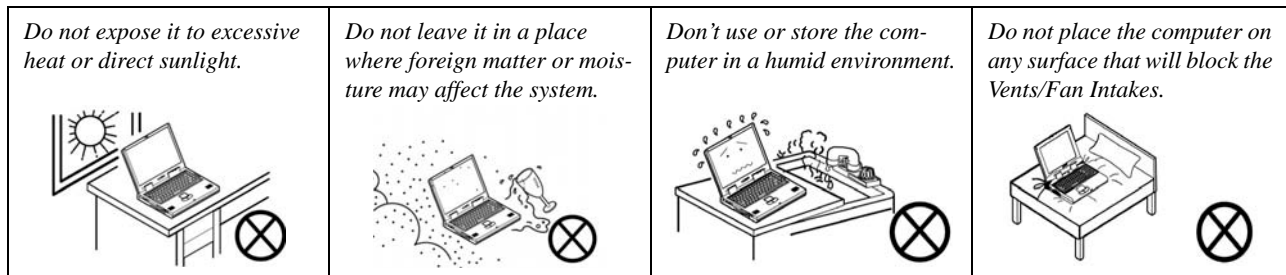

2. **Keep it dry, and don't overheat it.** Keep the computer and power supply away from any kind of heating element. This is an electrical appliance. If water or any other liquid gets into it, the computer could be badly damaged.

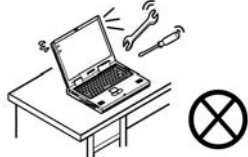

- Avoid interference.** Keep the computer away from high capacity transformers, electric motors, and other strong magnetic fields. These can hinder proper performance and damage your data.
- Follow the proper working procedures for the computer.** Shut the computer down properly and don't forget to save your work. Remember to periodically save your data as data may be lost if the battery is depleted.

<p><i>Do not turn off the power until you properly shut down all programs.</i></p> 	<p><i>Do not turn off any peripheral devices when the computer is on.</i></p> 	<p><i>Do not disassemble the computer by yourself.</i></p> 	<p><i>Perform routine maintenance on your computer.</i></p> 
--	---	---	---

- Take care when using peripheral devices.**

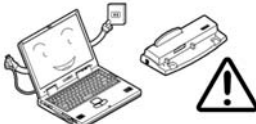
<p><i>Use only approved brands of peripherals.</i></p> 	<p><i>Unplug the power cord before attaching peripheral devices.</i></p> 
--	---

Power Safety

The computer has specific power requirements:



Power Safety Warning

Before you undertake any upgrade procedures, make sure that you have turned off the power, and disconnected all peripherals and cables (including telephone lines). It is advisable to also remove your battery in order to prevent accidentally turning the machine on.

- Only use a power adapter approved for use with this computer.
- Your AC/DC adapter may be designed for international travel but it still requires a steady, uninterrupted power supply. If you are unsure of your local power specifications, consult your service representative or local power company.
- The power adapter may have either a 2-prong or a 3-prong grounded plug. The third prong is an important safety feature; do not defeat its purpose. If you do not have access to a compatible outlet, have a qualified electrician install one.
- When you want to unplug the power cord, be sure to disconnect it by the plug head, not by its wire.
- Make sure the socket and any extension cord(s) you use can support the total current load of all the connected devices.
- Before cleaning the computer, make sure it is disconnected from any external power supplies (i.e. AC/DC adapter or car adapter).

Do not plug in the power cord if you are wet.



Do not use the power cord if it is broken.

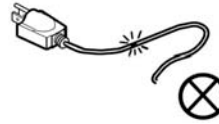

Do not place heavy objects on the power cord.

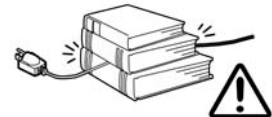

Battery Precautions

- Only use batteries designed for this computer. The wrong battery type may explode, leak or damage the computer.
- Do not remove any batteries from the computer while it is powered on.
- Do not continue to use a battery that has been dropped, or that appears damaged (e.g. bent or twisted) in any way. Even if the computer continues to work with a damaged battery in place, it may cause circuit damage, which may possibly result in fire.
- Recharge the batteries using the notebook's system. Incorrect recharging may make the battery explode.
- Do not try to repair a battery pack. Refer any battery pack repair or replacement to your service representative or qualified service personnel.
- Keep children away from, and promptly dispose of a damaged battery. Always dispose of batteries carefully. Batteries may explode or leak if exposed to fire, or improperly handled or discarded.
- Keep the battery away from metal appliances.
- Affix tape to the battery contacts before disposing of the battery.
- Do not touch the battery contacts with your hands or metal objects.



Battery Disposal & Caution

The product that you have purchased contains a rechargeable battery. The battery is recyclable. At the end of its useful life, under various state and local laws, it may be illegal to dispose of this battery into the municipal waste stream. Check with your local solid waste officials for details in your area for recycling options or proper disposal.

Danger of explosion if battery is incorrectly replaced. Replace only with the same or equivalent type recommended by the manufacturer. Discard used battery according to the manufacturer's instructions.

Preface

Cleaning

Do not apply cleaner directly to the computer; use a soft clean cloth.

Do not use volatile (petroleum distillates) or abrasive cleaners on any part of the computer.

Servicing

Do not attempt to service the computer yourself. Doing so may violate your warranty and expose you and the computer to electric shock. Refer all servicing to authorized service personnel. Unplug the computer from the power supply. Then refer servicing to qualified service personnel under any of the following conditions:

- When the power cord or AC/DC adapter is damaged or frayed.
- If the computer has been exposed to rain or other liquids.
- If the computer does not work normally when you follow the operating instructions.
- If the computer has been dropped or damaged (do not touch the poisonous liquid if the LCD panel breaks).
- If there is an unusual odor, heat or smoke coming from your computer.



Removal Warning

When removing any cover(s) and screw(s) for the purposes of device upgrade, remember to replace the cover(s) and screw(s) before turning the computer on.

Travel Considerations

Packing

As you get ready for your trip, run through this list to make sure the system is ready to go:

1. Check that the battery pack and any spares are fully charged.
2. Power off the computer and peripherals.
3. Close the display panel and make sure it's latched.
4. Disconnect the AC/DC adapter and cables. Stow them in the carrying bag.
5. The AC/DC adapter uses voltages from 100 to 240 volts so you won't need a second voltage adapter. However, check with your travel agent to see if you need any socket adapters.
6. Put the notebook in its carrying bag and secure it with the bag's straps.
7. If you're taking any peripherals (e.g. a printer, mouse or digital camera), pack them and those devices' adapters and/or cables.
8. Anticipate customs - Some jurisdictions may have import restrictions or require proof of ownership for both hardware and software. Make sure your "papers" are handy.



Power Off Before Traveling

Make sure that your notebook is completely powered off before putting it into a travel bag (or any such container). Putting a notebook which is powered on in a travel bag may cause the Vents/Fan Intakes to be blocked. To prevent your computer from overheating make sure nothing blocks the Vent/Fan Intakes while the computer is in use.

On the Road

In addition to the general safety and maintenance suggestions in this preface, and Chapter 8: Troubleshooting, keep these points in mind:

Hand-carry the notebook - For security, don't let it out of your sight. In some areas, computer theft is very common. Don't check it with "normal" luggage. Baggage handlers may not be sufficiently careful. Avoid knocking the computer against hard objects.

Beware of Electromagnetic fields - Devices such as metal detectors & X-ray machines can damage the computer, hard disk, floppy disks, and other media. They may also destroy any stored data - Pass your computer and disks around the devices. Ask security officials to hand-inspect them (you may be asked to turn it on). **Note:** Some airports also scan luggage with these devices.

Fly safely - Most airlines have regulations about the use of computers and other electronic devices in flight. These restrictions are for your safety, follow them. If you stow the notebook in an overhead compartment, make sure it's secure. Contents may shift and/or fall out when the compartment is opened.

Get power where you can - If an electrical outlet is available, use the AC/DC adapter and keep your battery(ies) charged.

Keep it dry - If you move quickly from a cold to a warm location, water vapor can condense inside the computer. Wait a few minutes before turning it on so that any moisture can evaporate.

Developing Good Work Habits

Developing good work habits is important if you need to work in front of the computer for long periods of time. Improper work habits can result in discomfort or serious injury from repetitive strain to your hands, wrists or other joints. The following are some tips to reduce the strain:

- Adjust the height of the chair and/or desk so that the keyboard is at or slightly below the level of your elbow. Keep your forearms, wrists, and hands in a relaxed position.
- Your knees should be slightly higher than your hips. Place your feet flat on the floor or on a footrest if necessary.
- Use a chair with a back and adjust it to support your lower back comfortably.
- Sit straight so that your knees, hips and elbows form approximately 90-degree angles when you are working.
- Take periodic breaks if you are using the computer for long periods of time.



Remember to:

- Alter your posture frequently.
- Stretch and exercise your body several times a day.
- Take periodic breaks when you work at the computer for long periods of time. Frequent and short breaks are better than fewer and longer breaks.



Lighting

Proper lighting and comfortable display viewing angle can reduce eye strain and muscle fatigue in your neck and shoulders.

- Position the display to avoid glare or reflections from overhead lighting or outside sources of light.
- Keep the display screen clean and set the brightness and contrast to levels that allow you to see the screen clearly.
- Position the display directly in front of you at a comfortable viewing distance.
- Adjust the display-viewing angle to find the best position.

Contents

Notice	I	Hot-Key Buttons & Keyboard	1-10
FCC Statement	II	Function Keys	1-11
Instructions for Care and Operation	IV	System Map: Front & Rear Views	1-12
Power Safety	VI	System Map: Left View	1-13
Battery Precautions	VII	System Map: Right View	1-14
Cleaning	VIII	System Map: Bottom View	1-15
Servicing	VIII	Windows XP Start Menu & Control Panel	1-16
Travel Considerations	IX	Video Features	1-17
		Display Devices & Options	1-19
		Power Management Features	1-20
Quick Start Guide		Features & Components	
Overview	1-1	Overview	2-1
Model Differences	1-2	Hard Disk Drive	2-2
Advanced Users	1-4	Optical (CD/DVD) Device	2-3
Beginners and Not-So-Advanced Users	1-4	Loading Discs	2-3
Warning Boxes	1-4	Handling CDs or DVDs	2-4
Not Included	1-5	DVD Regional Codes	2-5
System Software	1-5	4-in-1 Card Reader	2-6
System Startup	1-6	PC Card Slot	2-7
System Map: Model A - Top View		Inserting and Removing PC Cards	2-7
with LCD Panel Open	1-7	Auto Mail Checker	2-8
System Map: Model B - Top View		Application Hot-Key	2-10
with LCD Panel Open	1-8		
LED Indicators	1-9		

Preface

TouchPad and Buttons/Mouse	2-11
Configuring the TouchPad and Buttons	2-11
Audio Features	2-12
8 Channel Sound Support	2-13
Adding a Printer	2-14
USB Printer	2-14
Parallel Printer	2-14

Power Management

Overview	3-1
Advanced Configuration and Power Interface	3-1
The Power Sources	3-2
AC/DC Adapter	3-2
Battery	3-2
Turning on the Computer	3-3
Power Schemes	3-4
System Power Options	3-6
Hibernate Mode vs. Shutdown	3-6
Standby Mode vs. Hibernate Mode	3-6
Standby	3-7
Hibernate	3-7
Configuring the Power Button	3-8
Battery Information	3-9
New Battery	3-9

Battery Life	3-9
Recharging the Battery with the AC/DC Adapter	3-10
Proper handling of the Battery Pack	3-11
Battery FAQ	3-12
Swap Battery (Optional)	3-13

Drivers & Utilities

What to Install	4-1
Module Driver Installation	4-1
Service Packs	4-3
Authorized Driver Message	4-4
Version Conflict Message	4-4
Updating/Reinstalling Individual Drivers	4-4
Driver Installation	4-5
Driver Installation Procedure	4-6
New Hardware Found	4-6
Service Pack Installation	4-6
Manual Driver Installation	4-7
New Hardware Found	4-7
Chipset (WinXP)	4-8
Video (WinXP)	4-8
Audio (WinXP)	4-8
LAN (WinXP)	4-9
Modem (WinXP)	4-9

TouchPad (WinXP) 4-10
 PCMCIA/Card Reader (WinXP) 4-10
 Hot-Key (WinXP) 4-11
 AutoMail (WinXP) 4-11
 Wireless LAN 4-12
 Bluetooth 4-12
 PC Camera 4-12
 Port Replicator 4-12

BIOS Utilities

Overview 5-1
 The Power-On Self Test (POST) 5-2
 Failing the POST 5-3
 Fatal Errors 5-3
 Non-Fatal Errors 5-3
 The Setup Program 5-4
 Entering Setup 5-4
 Setup Screens 5-5
 Main Menu 5-6
 System Time & Date (Main Menu) 5-6
 IDE Channel 0 Master/Slave (Main Menu) 5-7
 System/Extended Memory (Main Menu) 5-7
 Advanced Menu 5-8
 Installed O/S: (Advanced Menu) 5-8
 Reset Configuration Data (Advanced Menu) 5-9

Large Disk Access Mode (Advanced Menu) 5-9
 Local Bus IDE adapter (Advanced Menu) 5-9
 Legacy USB Support (Advanced Menu) 5-9
 Summary Screen: (Advanced Menu) 5-9
 Boot-time Diagnostic Screen: (Advanced Menu) 5-9
 Security Menu 5-10
 Set Supervisor Password (Security Menu) 5-10
 Set User Password (Security Menu) 5-11
 Password on boot: (Security Menu) 5-11
 Boot Menu 5-12
 Exit Menu 5-14

Upgrading The Computer

Overview 6-1
 When Not to Upgrade 6-2
 Removing the Battery 6-3
 Upgrading the Hard Disk Drive 6-5
 Upgrading the Optical (CD/DVD) Device 6-8
 Upgrading the System Memory (RAM) 6-9
 Upgrading the Processor 6-12

Modules & Options

Overview 7-1
 Intel PRO/Wireless Mini-PCI WLAN Module 7-2

Preface

Intel WLAN Driver Installation	7-3
Bluetooth Module	7-4
Bluetooth Driver Installation	7-4
PC Camera	7-6
Sertek PC Camera Driver Installation (WinXP) ...	7-7
PC Camera Audio Setup	7-8
BisonCap	7-10
Eliminating Screen Flicker	7-11
Port Replicator	7-12
Port Replicator Setup Instructions:	7-13
Port Replicator Serial (COM) Port Driver (WinXP)	7-14
Port Replicator Network (LAN) Driver (WinXP)	7-14

Troubleshooting

Overview	8-1
Basic Hints and Tips	8-2
Backup and General Maintenance	8-3
Viruses	8-4
Upgrading and Adding New Hardware/Software	8-5
Power	8-7
Display	8-9
Boot Password	8-10
Audio & CD Device	8-11

Keyboard	8-12
Operation	8-13
Modules	8-14

Interface (Ports & Jacks)

Overview	A-1
Notebook Ports and Jacks	A-2
Built-In Microphone	A-2
Card Reader Port	A-2
DC-In Jack	A-2
External Monitor (VGA) Port	A-2
Headphone-Out Jack	A-2
Line-In Jack	A-2
Microphone-In Jack	A-3
Mini-IEEE 1394 Port	A-3
RJ-11 Phone Jack	A-3
RJ-45 LAN Jack	A-3
Security Lock Slot	A-3
S/PDIF-Out Jack	A-4
S-Video-Out Port	A-4
USB 2.0/1.1 Ports	A-4
Optional Port Replicator Ports and Jacks	A-5
DC-In Jack	A-5
External Monitor (VGA) Port	A-5
Parallel Port	A-5

Serial PortA-5
 RJ-45 LAN JackA-5
 USB 2.0/1.1 PortsA-6

Intel Video Driver Controls

Intel Video Driver Installation B-1
 Dynamic Video Memory Technology B-2
 Intel Graphics Properties B-3
 Schemes B-5
 Display Devices B-6
 Attaching Other Displays B-7
 Display Modes B-8
 TV Settings B-12

Specifications

Processor C-2
 Core Logic C-2
 Memory C-2
 Security C-2
 BIOS C-2
 LCD C-2
 Video Adapter C-3
 Storage C-3
 Audio C-3

Keyboard & Pointing DeviceC-3
 PCMCIAC-3
 InterfaceC-4
 Card ReaderC-4
 CommunicationC-4
 Power ManagementC-4
 PowerC-5
 Environmental SpecC-5
 Physical Dimensions & WeightC-5
 OptionalC-5

Chapter 1: Quick Start Guide

Overview

This Quick Start Guide is a brief introduction to the basic features of your computer, to navigating around the computer and to getting your system started. The remainder of the manual covers the following:

- **Chapter 2** A guide to using some of the main features of the computer e.g. the **storage devices (hard disk, optical device, 4-in-1 card reader, PC Card), Auto Mail Program, Touch Pad & Mouse, Audio & Printer.**
- **Chapter 3** The computer's **power** saving options.
- **Chapter 4** The installation of the **drivers** and utilities essential to the operation or improvement of some of the computer's subsystems.
- **Chapter 5** An outline of the computer's built-in software or **BIOS** (Basic Input Output System).
- **Chapter 6** Instructions for **upgrading** your computer.
- **Chapter 7** A quick guide to the computer's **Wireless LAN, Bluetooth, PC Camera and Port Replicator modules** (some of which may be **optional** depending on your purchase configuration).
- **Chapter 8** A **troubleshooting** guide.
- **Appendix A** Definitions of the **interface, ports/jacks** which allow your computer to communicate with external devices.
- **Appendix B** Information on the Intel Video **driver controls.**
- **Appendix C** The computer's **specification.**

Model Differences

This notebook series includes **two** different model types. The models differ slightly in design style including the LCD type, and the location of the card reader. See *Figure 1 - 1* below and *Table 1 - 1, on page 1 - 3* for an outline of the model differences.



Figure 1 - 1 - Model Differences



Feature	Model A	Model B
LCD Type	15.0" XGA (1024 * 768) TFT OR 15.0" SXGA+ (1400 * 1050) TFT	14.0" WXGA (1280 * 768) TFT
4-in-1 Card Reader Location	Left Side	Front
Hot-Key and Power Buttons	 A black rectangular panel with four buttons: a left arrow, a right arrow, a refresh/cycle button, and a power button.	 A white rectangular panel with four buttons: a left arrow, an envelope icon, a refresh/cycle button, and a power button.

Table 1 - 1 - Model Differences

Advanced Users

If you are an advanced user you may skip over most of this Quick Start Guide. However you may find it useful to refer to *“What to Install” on page 4 - 1*, *“BIOS Utilities” on page 5 - 1* and *“Upgrading The Computer” on page 6 - 1* in the User’s Manual. You may also find the notes marked with a  of interest to you.

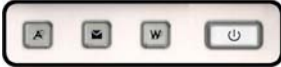

Notes

Check the light colored boxes with the mark above to find detailed information about the computer’s features.

Beginners and Not-So-Advanced Users

If you are new to computers (or do not have an advanced knowledge of them) then the information contained in the this Quick Start Guide should be enough to get you up and running. Eventually you should try to look through all the documentation (more detailed descriptions of the functions, setup and system controls are covered in the remainder of the User’s Manual), but do not worry if you do not understand everything the first time. Keep this manual nearby and refer to it to learn as you go. You may find it useful to refer to the notes marked with a  as indicated in the margin. For a more detailed description of any of the interface ports and jacks see *“Interface (Ports & Jacks)” on page A - 1*.

Warning Boxes

No matter what your level please pay careful attention to the warning and safety information indicated by the  symbol. Also please note the safety and handling instructions as indicated in the *Preface*.

Not Included

Operating Systems (e.g. *Windows XP*) and applications (e.g. word processing, spreadsheet and database programs) have their own manuals, so please consult the appropriate manuals.

System Software

Your computer may already come with system software pre-installed. Where this is not the case, or where you are re-configuring your computer for a different system, you will find this manual refers to the *Microsoft Windows XP (Home & Professional Editions)* operating system.



Drivers

If you are installing new system software, or are re-configuring your computer for a different system, you will need to install the drivers listed in ***“Drivers & Utilities” on page 4 - 1***. Drivers are programs which act as an interface between the computer and a hardware component e.g. a wireless network module. It is very important that you install the drivers in the order listed in ***Table 4 - 1, on page 4 - 6***. You will be unable to use most advanced controls until the necessary drivers and utilities are properly installed. If your system hasn't been properly configured (your service representative may have already done that for you), refer to ***“What to Install” on page 4 - 1*** for installation instructions.

System Startup

1. Remove all packing materials.
2. Place the computer on a stable surface.
3. Securely attach any peripherals you want to use with the notebook (e.g. keyboard and mouse) to their ports.
4. Attach the AC/DC adapter to the DC-In jack on the right of the computer, then plug the AC power cord into an outlet, and connect the AC power cord to the AC/DC adapter (**Note:** If you have included the Port Replicator in your purchase option see page [7 - 12](#)).
5. Raise the lid/LCD (you will need to press the LCD latch to release the lid of **Model A** computers) to a comfortable viewing angle, and press the power button to turn the computer “on”.
6. Adjust the LCD panel to a comfortable viewing angle.
7. The LED Power & Communication indicators show the power and battery status of the computer, and give notification of e-mail received.

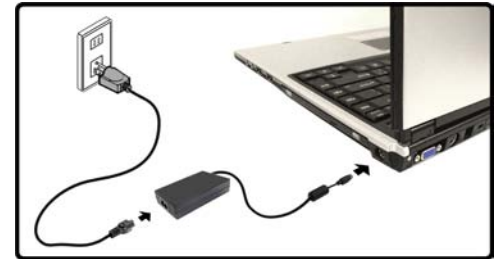

Figure 1 - 2 - Computer with AC/DC Adapter Plugged-In



Shutdown

Please note that you should always shut your computer down by choosing the **Turn Off Computer** command from the **Start** menu in **Windows**. This will help prevent hard disk or system problems.

System Map: Model A - Top View with LCD Panel Open



Wireless Device Operation Aboard Aircraft

The use of any portable electronic transmission devices aboard aircraft is usually prohibited. Make sure the module(s) are OFF if you are using the computer aboard aircraft.

Use the key combinations to toggle power to the WLAN/Bluetooth modules, and check the status indicator icon to see if the modules are powered on or not (see [Table 1-3, on page 1-9](#)/[Table 1-5, on page 1-11](#)).



1. Optional Built-In PC Camera
2. LCD
3. LED Status Indicators
4. Hot-Key Buttons
5. Power Button
6. Keyboard
7. Built-In Microphone
8. TouchPad and Buttons
9. LED Power & Communication Indicators

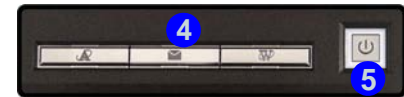
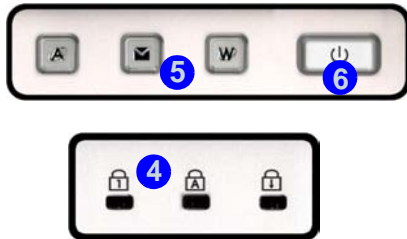

Figure 1 - 3 - Model A - Top View with LCD Panel Open

System Map: Model B - Top View with LCD Panel Open

1. Optional Built-In PC Camera
2. LCD
3. Speaker
4. LED Status Indicators
5. Hot-Key Buttons
6. Power Button
7. Keyboard
8. TouchPad and Buttons
9. LED Power & Communication Indicators
10. Built-In Microphone



Wireless Device Operation Aboard Aircraft

The use of any portable electronic transmission devices aboard aircraft is usually prohibited. Make sure the module(s) are OFF if you are using the computer aboard aircraft.



Use the key combinations to toggle power to the WLAN/Bluetooth modules, and check the status indicator icon to see if the modules are powered on or not (see [Table 1 - 3, on page 1 - 9](#)/[Table 1 - 5, on page 1 - 11](#)).

Figure 1 - 4 - Model B - Top View with LCD Panel Open

LED Indicators

The two sets of LED indicators (**LED Status Indicators** and **LED Power & Communication Indicators**) on the computer display helpful information about the current status of the computer.

Table 1 - 2 - LED Status Indicators

Icon	Color	Description
	Green	Number Lock Activated (to activate press Fn & NumLk)
	Green	Caps Lock Activated
	Green	Scroll Lock Activated (to activate press Fn & ScrLk)



Swap Battery







The  icon will provide additional information on the **optional** swap battery status (optional for **Model A** computers only). See **“Swap Battery (Optional)” on page 3 - 13** for details.



Table 1 - 3 - LED Power & Communication Indicators

Icon	Color	Description
	Green	The Computer is On
	Blinking Green	The Computer is in Standby Mode
	Orange	The AC/DC Adapter is Plugged In & the Computer is Powered Off
	Orange	The AC/DC Adapter is Plugged In & the Battery is Charging
	Blinking Orange	The Battery has Reached Critically Low Power Status
	Green	The Battery is Fully Charged
	Blinking Green	New Mail Has Arrived
	Green	Hard Disk Activity
	Green	The WLAN Module is Powered On
	Orange	The Bluetooth Module is Powered On

Hot-Key Buttons & Keyboard

These buttons give instant access to the default Internet browser and e-mail program, and to a user-defined application, with one quick button press. To use the “user-defined application Hot-Key Button”, you must install the driver (see *“Hot-Key (WinXP)” on page 4-11*).

Table 1 - 4 - Hot-Key Buttons

Hot-Key	Function
	Activate the user specified application e.g. Microsoft Word or Excel
	Activate the Default E-Mail Program
	Activate the Default Internet Browser

See *“Application Hot-Key” on page 2 - 10* for configuration instructions.

The keyboard has an embedded numerical keypad for easy numeric data input, and features Function Keys to allow you to change operational features instantly (see *Figure 1 - 5*).

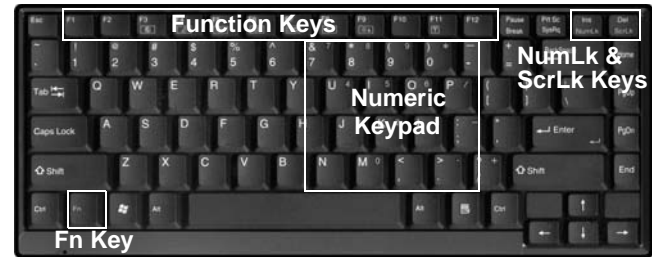

Figure 1 - 5 - Keyboard



Other Keyboards

If your keyboard is damaged or you just want to make a change, you can use any standard USB keyboard. The system will detect and enable it automatically. However special functions/hot keys unique to the system's regular keyboard may not work.

Function Keys

To use the function keys, press and hold the **Fn** key, then press the appropriate function key (F3 - F12 etc.).

Key	Function	Key	Function
Fn	Function Key	Fn + F9	Increase LCD Brightness
Fn + F3	Mute Toggle	Fn + F10	PC Camera Power Toggle
Fn + F4	Sleep Toggle	Fn + F11	Wireless Power Toggle
Fn + F5	Decrease Audio Volume	Fn + F12	Bluetooth Power Toggle
Fn + F6	Increase Audio Volume	Fn + NumLk	Number Lock Toggle
Fn + F7	Display Toggle	Fn + ScrLk	Scroll Lock Toggle
Fn + F8	Decrease LCD Brightness		

Table 1 - 5 - Function Keys



Special Characters

Some software applications allow the number-keys to be used with **Alt** to produce special characters. These special characters can only be produced by using the numeric keypad. Regular number keys (in the upper row of the keyboard) will not work. Make sure that **NumLk** is on.

System Map: Front & Rear Views

Figure 1 - 6

Front & Rear Views

1. LED Power & Communication Indicators
2. LCD Latch (**Model A** Only)
3. 4-in-1 Card Reader (**Model B** Only)
4. External Monitor Port
5. S-Video-Out Port
6. RJ-11 Phone Jack
7. Security Lock Slot
8. Battery

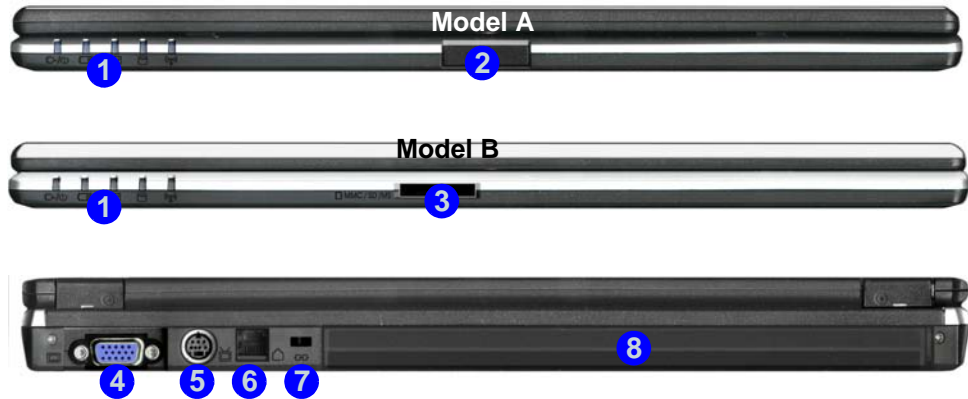

4-in-1 Card Reader

The card reader allows you to use the most popular digital storage card formats:

MMC (MultiMedia Card) / SD (Secure Digital) / MS (Memory Stick) / MS Pro (Memory Stick Pro)

System Map: Left View

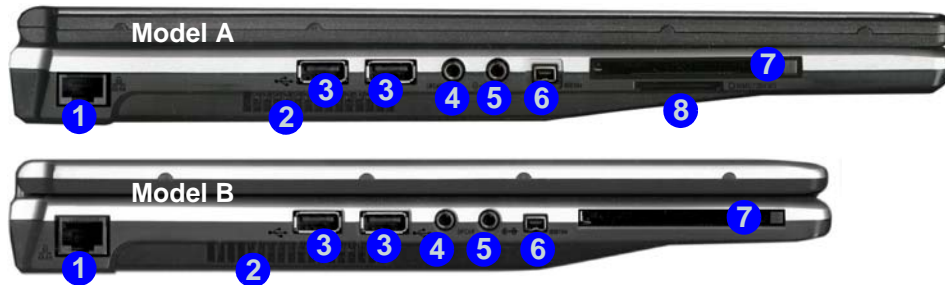

Figure 1 - 7
Left View

1. RJ-45 LAN Jack
2. Vent/Fan Intake
3. 2 * USB 2.0 Ports
4. S/PDIF-Out Jack
5. Line-In Jack
6. Mini-IEEE 1394 Port
7. PC Card Slot (see page [2 - 7](#))
8. 4-in-1 Card Reader (Model A Only)



4-in-1 Card Reader

The card reader allows you to use the most popular digital storage card formats:

MMC (MultiMedia Card) / SD (Secure Digital) / MS (Memory Stick) / MS Pro (Memory Stick Pro)

System Map: Right View

Figure 1 - 8 - Right View

1. Headphone-Out Jack
2. Microphone-In Jack
3. 2 * USB 2.0 Ports
4. Optical Device Drive Bay (for CD/
DVD Device - see page 2 - 3)
5. DC-In Jack



CD Emergency Eject

If you need to manually eject a CD/DVD (e.g. due to an unexpected power interruption) you may push the end of a straightened paper clip into the emergency eject hole. Do not use a sharpened pencil or similar object that may break and become lodged in the hole.

Media Warning

Don't try to remove a floppy disk/CD/DVD while the system is accessing it. This may cause the system to "crash".



Changing DVD Regional Codes

Go to the **Control Panel** and double-click **System > Hardware** (tab), click **Device Manager**, then click the **+** next to **DVD/CD-ROM drives**. Double-click on the DVD-ROM device to bring up the **Properties** dialogue box, and select the **DVD Region** (tab) to bring up the control panel to allow you to adjust the regional code (see "[DVD Regional Codes](#)" on [page 2 - 5](#)).

DVD region detection is device dependent, not OS-dependent. You can select your module's region code **5** times. The fifth selection is permanent. This cannot be altered even if you change your operating system or you use the module in another computer.

System Map: Bottom View



CPU

The CPU is not a user serviceable part. Opening this compartment, or accessing the CPU in any way, may violate your warranty.

Overheating

To prevent your computer from overheating make sure nothing blocks the Vent/Fan Intake while the computer is in use.

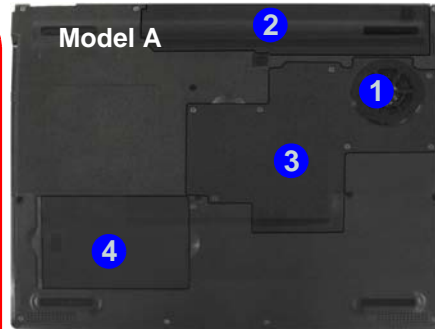
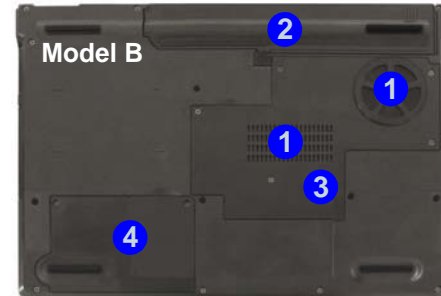

Figure 1 - 9 - Bottom View

1. Vent/Fan Intake
2. Battery
3. Memory (RAM)/WLAN Module/CPU Cover
4. Hard Disk Cover



Battery Information

Always completely discharge, then fully charge, a new battery before using it. Completely discharge and charge the battery at least once every 30 days or after about 20 partial discharges. See [“Battery Information” on page 3 - 9](#) for full instructions.

Windows XP Start Menu & Control Panel

Most of the control panels, utilities and programs within *Windows XP* (and most other *Windows* versions) are accessed from the **Start** menu. When you install programs and utilities they will be installed on your hard disk drive, and a shortcut will usually be placed in the **Start** menu and/or the desktop. You can customize the look of the **Start** menu by right-clicking the **Start** menu and selecting **Properties** from the menu.



Figure 1 - 10 - Start Menu & Control Panel

In many instances throughout this manual you will see an instruction to open the **Control Panel**. The **Control Panel** is accessed from the **Start** menu, and it allows you to configure the settings for most of the key features in *Windows* (e.g. power, video, network, audio etc.). *Windows XP* provides basic controls for many of the features, however many new controls are added (or existing ones are enhanced) when you install the drivers listed in *Table 4 - 1, on page 4 - 6*. To see all controls it may be necessary to toggle off Category View.

Video Features

Your computer will have built-in **Intel (Intel GMA 900)** on-board video. You can switch display devices, and configure display options, from the **Display Properties** control panel in *Windows* as long as the appropriate **video driver** is installed. For more detailed video information see *“Intel Video Driver Controls” on page B - 1*.

To access Display Properties in *Windows*:

1. Click **Start**, point to **Settings** and click **Control Panel** (or just click **Control Panel**).
2. Double-click **Display** (icon) - In the **Appearances and Themes** category.
3. Click **Settings** (tab) in the **Display Properties** dialog box.
4. Move the slider to the preferred setting in **Screen area/resolution** ① (*Figure 1 - 11 on page 1 - 18*).
5. Click the arrow, and scroll to the preferred setting In **Colors/Color quality** ② (*Figure 1 - 11 on page 1 - 18*).
6. You can also access **Display Properties** by right-clicking the desktop and scrolling down and clicking **Properties**. Click **Settings** (tab) and adjust as above.
7. Open the **Display Properties** control panel, and click **Advanced** (button) ③ (*Figure 1 - 11 on page 1 - 18*) to bring up the **Advanced properties** tabs.
8. Click the **Intel(R) Graphics Media Accelerator Driver** tab, and click **Graphics Properties** (button) to make any video adjustments you require.

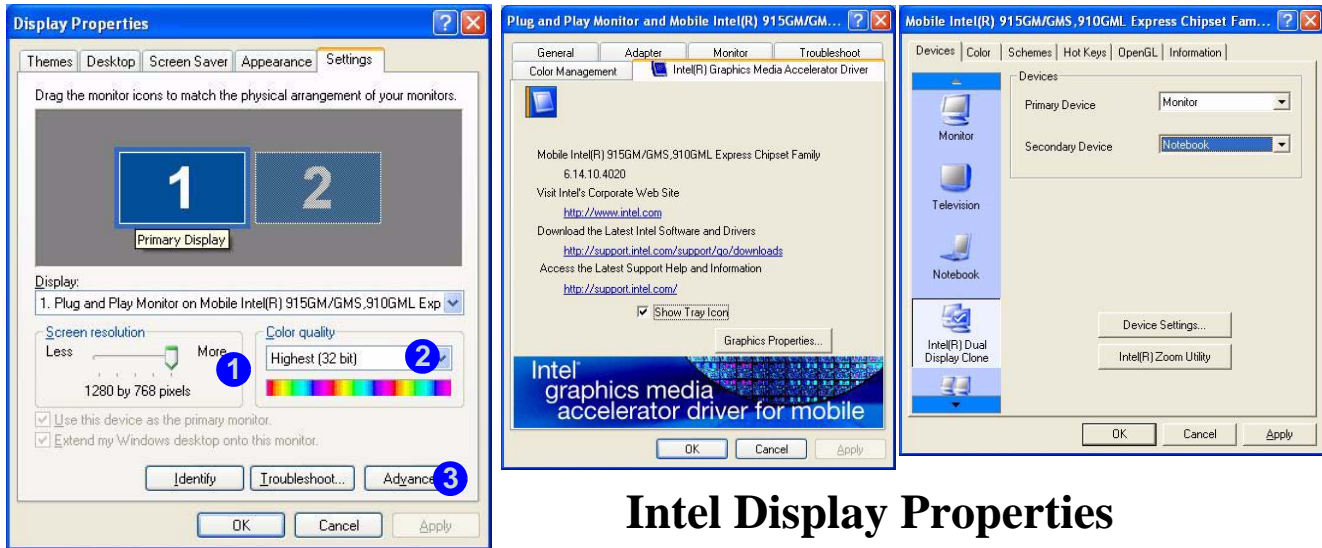

Figure 1 - 11 - Display Properties Desktop

Display Devices & Options

Besides the built-in LCD, you can also use an **external VGA monitor** (CRT)/**external Flat Panel Display** or **TV** as your display device. A VGA monitor/Flat Panel Display connects to the external monitor port, a TV to the S-Video-Out Port. The following display modes are available (see *“Intel Video Driver Controls” on page B - 1* for details).

Intel Display Mode	Description
Single Mode	One of the connected displays is used as the display device
Intel(R) Dual Display Clone Mode	Both connected displays output the same view and may be configured independently
Extended Desktop Mode	Both connected displays are treated as separate devices, and act as a virtual desktop

Table 1 - 6 - Display Options



Intel Display Note

Note that the monitor is the default Primary display device in both Intel(R) Dual Display Clone Mode and Extended Desktop Mode.

Power Management Features

The **Power Options** control panel icon in *Windows* (see page [1 - 16](#)) allows you to configure power management features for your computer. You may conserve power through individual components such as the monitor or hard disk (by means of **Power Schemes**), or you may use either **Standby** or **Hibernate** mode to conserve power throughout the system (enable **Hibernate** support from the control panel as pictured in [Figure 1 - 12](#)). Pay attention to the instructions on battery care in *“Battery Information”* on page [3 - 9](#).

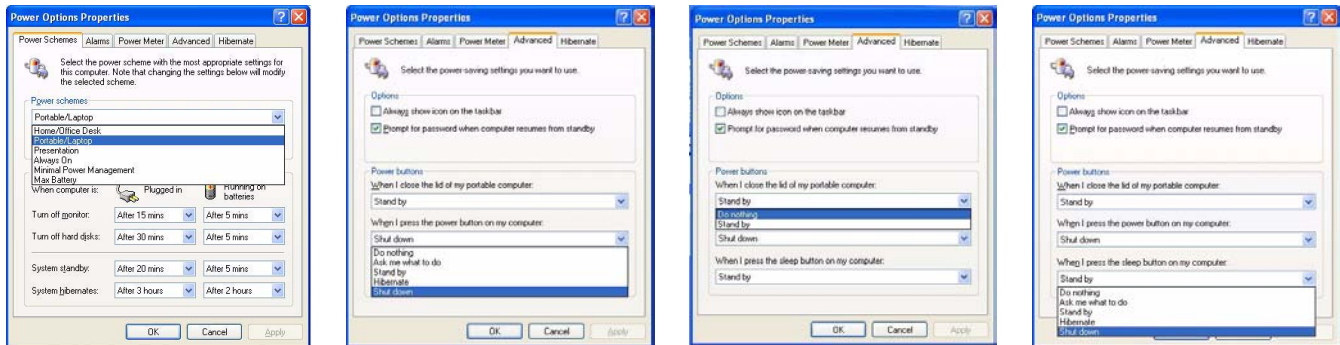

Figure 1 - 12 - Power Options

The computer’s **power button**, **sleep button** (**Fn + F4** key combination), and **lid** (closing the lid) may be set to send the computer in to either **Standby** or **Hibernate** mode.

Power Saving and Performance

Power Schemes may have an affect on your computer performance (see *“Power Schemes”* on page [3 - 4](#)).

Chapter 2: Features & Components

Overview

Read this chapter to learn more about the following main features and components of the computer:

- Hard Disk Drive
- Optical (CD/DVD) Device
- 4-in-1 Card Reader
- PC Card Slot
- Auto Mail Checker
- Application Hot-Key
- TouchPad and Buttons/Mouse
- Audio Features
- Adding a Printer



Power Safety

Before attempting to access any of the internal components of your computer please ensure that the machine is not connected to the AC power, and that the machine is turned off. Also ensure that all peripheral cables, including phone lines, are disconnected from the computer.

Hard Disk Drive

The hard disk drive is used to store your data in the computer. The hard disk can be taken out to accommodate other 2.5" parallel (PATA) hard disk drives with a height of 9.5 mm.

The hard disk is accessible from the bottom of your computer as seen below. For further details see [“Upgrading the Hard Disk Drive” on page 6 - 5](#).

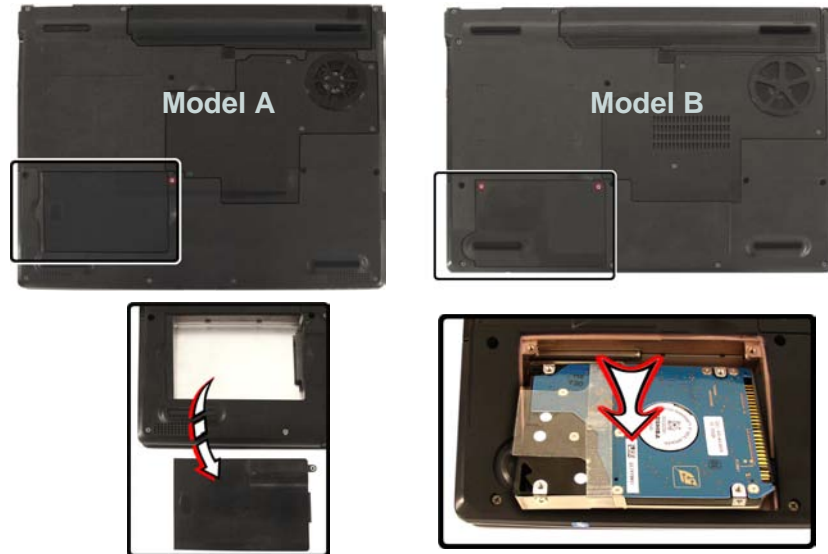

Figure 2 - 1
Hard Disk Location

Optical (CD/DVD) Device

There is a bay for a 5.25" optical (CD/DVD) device (12.7mm height). The actual device will depend on the module you purchased (see *“Storage” on page C - 3*). The optical device is usually labeled **“Drive D:”** and may be used as a boot device if properly set in the **BIOS** (see *“Boot Menu” on page 5 - 12*).

Loading Discs

To insert a CD/DVD, press the open button **1** and carefully place a CD/DVD onto the disc tray with label-side facing up (use just enough force for the disc to click onto the tray’s spindle). Gently push the CD/DVD tray in until its lock “clicks” and you are ready to start. The busy indicator **2** will light up while data is being accessed, or while an audio/video CD, or DVD, is playing. If power is unexpectedly interrupted, insert an object such as a straightened paper clip into the emergency eject hole **3** to open the tray.



Sound Volume Adjustment

How high the sound volume can be set depends on the setting of the volume control within **Windows**. Click the **Volume** icon on the taskbar to check the setting (see *“Audio Features” on page 2 - 12*).

Figure 2 - 2
Optical Device



CD Emergency Eject

If you need to manually eject a CD (e.g. due to an unexpected power interruption) you may push the end of a straightened paper clip into the emergency eject hole. However please do NOT use a sharpened pencil or similar object that may break and become lodged in the hole.

Disk Eject Warning

Don't try to remove a CD/DVD while the system is accessing it. This may cause the system to "crash".

Handling CDs or DVDs

Proper handling of your CDs/DVDs will prevent them from being damaged. Please follow the advice below to make sure that the data stored on your CDs/DVDs can be accessed.

Note the following:

- Hold the CD or DVD by the edges; do not touch the surface of the disc.
- Use a clean, soft, dry cloth to remove dust or fingerprints.
- Do not write on the surface with a pen.
- Do not attach paper or other materials to the surface of the disc.
- Do not store or place the CD or DVD in high-temperature areas.
- Do not use benzene, thinner, or other cleaners to clean the CD or DVD.
- Do not bend the CD or DVD.
- Do not drop or subject the CD or DVD to shock.

DVD Regional Codes

To change the DVD regional codes see *“Changing DVD Regional Codes” on page 1 - 14.*

DVD Regional Coding	
Region	Geographical Location
1	USA, Canada
2	Western Europe, Japan, South Africa, Middle East & Egypt
3	South-East Asia, Taiwan, South Korea, The Philippines, Indonesia, Hong Kong
4	South & Central America, Mexico, Australia, New Zealand
5	N Korea, Russia, Eastern Europe, India & Most of Africa
6	China

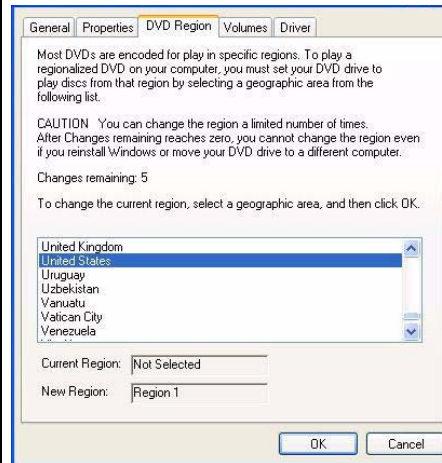

Table 2 - 1
DVD Regional Coding

Figure 2 - 3
DVD Regions



Card Reader Cover

Make sure you keep the cover in the card reader when not in use. This will help prevent foreign objects and/or dust getting in to the card reader.

4-in-1 Card Reader

The card reader allows you to use some of the latest digital storage cards. Push the card into the slot and it will appear as a removable device, and can be accessed in the same way as your hard disk (s). Make sure you install the PCMCIA/Card Reader Card driver (see *“PCMCIA/Card Reader (WinXP)” on page 4 - 10*).

- MMC (MultiMedia Card)
- SD (Secure Digital)
- MS (Memory Stick)
- MS Pro (Memory Stick Pro)

Figure 2 - 4
Removable Disks

1. Card Reader



Model A (Left)



Model B (Front)

PC Card Slot

The computer is equipped with a PCMCIA 3.3V/5V slot for **one type II PC-MCIA CardBus PC Card Slot**. Make sure you install the PCMCIA/Card Reader Card driver (see *“PCMCIA/Card Reader (WinXP)” on page 4 - 10*).

Inserting and Removing PC Cards

- Align the PC Card with the slot and push it in until it locks into place.
- To remove a PC Card, simply press the eject button **1** next to the slot.



PC Card Slot Cover

Make sure you keep the cover in the PC Card slot when not in use. This will help prevent foreign objects and/or dust getting in to the PC Card Slot.

Figure 2 - 5
PC Card Slot

Auto Mail Checker

After you have installed the driver for the Auto Mail Checker program (see “*AutoMail (WinXP)*” on page 4 - 11) you may then configure it to give you notification when you receive new mail. You must be online to receive this notification (note that this program only supports the **POP3** protocol), and your default mail program does not need to be open.

The Auto Mail Checker appears as an icon  in the **taskbar** (if you do not see the icon in the taskbar go to **Start > Programs/All Programs > Auto Mail Checker > Auto Mail Checker**). Right clicking on the icon will bring up the following options menu. If you have not input your mail account data, then you will be prompted to do so.

Figure 2 - 6
Auto Mail Checker



Select **Open** to bring up the control panel for the program.

You may then configure the options for your mailserver, name, password, program and method(s) of notification.

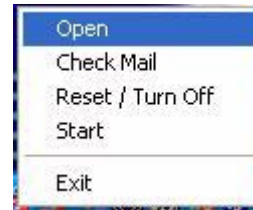
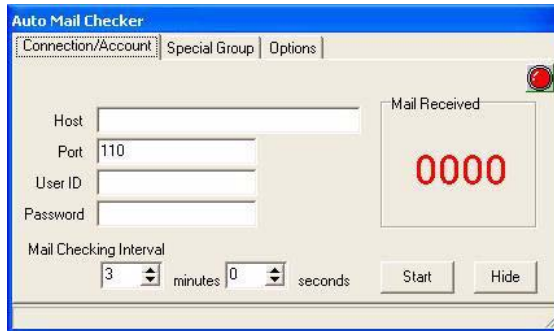

Note

Check with your Internet Service Provider, network administrator or Mail Service provider for details on what to put on these pages.

Figure 2 - 7
**Auto Mail Checker
Account Setup and
Options**



Application.exe

You will need to locate the actual **application executable (.exe) file**, not just the **shortcut**. To find the application right-click its **shortcut** on the desktop and click **Properties**. Click the **shortcut** (tab) and see where the executable file is located by clicking the **Find Target** (button).

Application Hot-Key

The hot-key buttons give instant access to the default Internet browser and e-mail program, and to a user-defined application, with one quick button press. To configure a program to open when the application hot-key  is pressed (*Windows Media Player* is the default program), follow the instructions below.

1. **Right click** the Hot-Key driver icon  in the **taskbar**.
2. Select **Setup** from the menu, scroll to **Application 1** and press **Enter**.



3. An **Open** dialog box will appear on the screen.

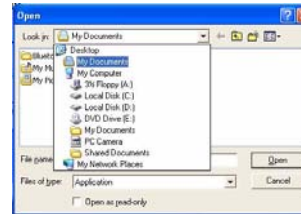

4. **Browse** to the directory where the desired application.exe (see the sidebar) program exists.
5. **Double-Click** on the program file or choose **Open**.

Figure 2 - 8
Hot-Key Configuration Screens

TouchPad and Buttons/Mouse

The TouchPad is an alternative to the mouse; however, you can also add a mouse to your computer through one of the USB ports. The TouchPad buttons function in much the same way as a two-button mouse. The central button may be configured to function as you require.

Configuring the TouchPad and Buttons

Once you have installed the TouchPad driver you can configure the functions by double-clicking the TouchPad driver icon  on the **taskbar**, or by going to the **Mouse** control panel in **Windows** (**Start** menu and point to **Settings** and click **Control Panel**, then double-click the **Mouse** icon). In **Windows XP** the **Mouse** control panel is in the **Printers and Other Hardware Category**.

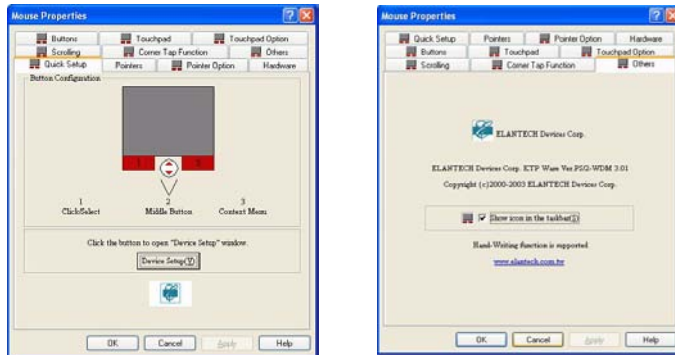

Figure 2 - 9
Mouse Properties



Mouse Driver

If you are using an external mouse your operating system may be able to auto-configure your mouse during its installation or only enable its basic functions. Be sure to check the device's user documentation for details.



Sound Volume Adjustment

How high the sound volume can be set depends on the setting of the volume control within **Windows**. Click the Volume icon on the taskbar to check the setting.



Figure 2 - 10
Realtek Audio Configuration Menus

Audio Features

You can configure the audio options on your computer from the **Sounds and Audio Devices**  **Windows** control panel, or from the **Sound Effect Manager**  icon in the taskbar/control panel (this will bring up the Realtek Audio Configuration menus). The volume may also be adjusted by means of the **Fn + F5/F6** key combination.



8 Channel Sound Support

If you wish to configure your system for 8 channel sound support, then the following ports should be used as outputs. Double-click the appropriate icon (e.g. ) to bring up the “**Connected device:**” dialog box to configure the output port.

- Side Speaker Out - Connect to S/PDIF Out
- Center/Subwoofer Speaker Out - Connect to Microphone In
- Front Speaker Out - Connect to Speaker/Headphone Out
- Rear Speaker Out - Connect to Line In

Figure 2 - 11
8 Channel Sound Support

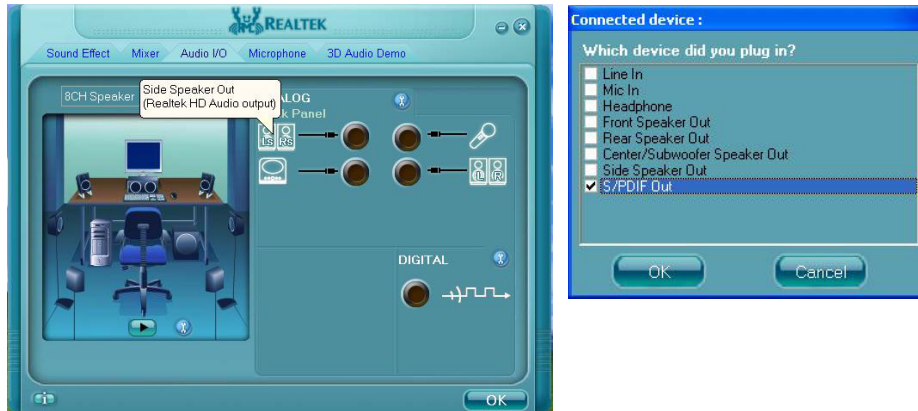



Parallel Printer

After setting up the printer attach the parallel cable to the printer.

Connect the printer's parallel cable to the Parallel to USB converter, and then plug the converter into the USB port.

Turn ON the printer, then turn ON the computer.

Windows will identify the printer and either load one of its own drivers or ask you to supply one. Follow the on-screen instructions.

Adding a Printer

The most commonly used peripheral is a printer. The following conventions will help you to add a printer, however it is always best to refer to the printer manual for specific instructions and configuration options.

USB Printer

Most current printers have a USB interface connection. You may use any one of the ports to connect the printer.

Install Instructions:

1. Set up the printer according to its instructions (unpacking, paper tray, toner/ink cartridge etc.).
2. Turn ON the computer.
3. Turn ON the printer.
4. Connect the printer's USB cable to one of the USB ports on the computer.
5. **Windows** will identify the printer and either load one of its own drivers or ask you to supply one. Follow the on-screen instructions.

Parallel Printer

This is still a very common type of printer. The install instructions are in the sidebar. **Note:** If you have included the **Port Replicator** in your purchase option, then a parallel port will be available, otherwise you will need to purchase a parallel to USB converter.

Chapter 3: Power Management

Overview

To conserve power, especially when using the battery, your computer uses the ACPI power management system. Power management conserves power by controlling individual components of the computer (the monitor and hard disk drive) or the whole system. This chapter covers:

- The Power Sources
- Turning on the Computer
- Power Schemes
- System Power Options
- Configuring the Power Button
- Battery Information
- Swap Battery (Optional)

Advanced Configuration and Power Interface

The **ACPI** interface provides the computer with enhanced power saving techniques and gives the operating system (OS) direct control over the power and thermal states of devices and processors. For example, it enables the OS to set devices into low-power states based on user settings and information from applications. ACPI is fully supported in *Windows XP*.



OS Note

Power management functions will vary slightly depending on your operating system. For more information it is best to refer to the user's manual of your operating system.

(Note: All pictures used on the following pages are from the *Windows XP* OS.)



Port Replicator AC/DC Adapter

You will be provided with a **90W AC/DC adapter** if you purchase the port replicator option.

If you are using the computer with the Port Replicator, then you **must use the 90W AC/DC adapter** to power the port replicator and computer (**DO NOT USE the computer's 65W AC/DC adapter to power the Port Replicator**). See *“Port Replicator” on page 7 - 12* for more information.

The Power Sources

The computer can be powered by either an AC/DC adapter or a battery pack.

AC/DC Adapter

Use only the AC/DC adapter that comes with your computer. The wrong type of AC/DC adapter will damage the computer and its components.

1. Attach the AC/DC adapter to the DC-in jack on the right of the computer.
2. Plug the AC power cord into an outlet, and then connect the AC power cord to the AC/DC adapter (see sidebar if you are using the optional Port Replicator).
3. Raise the lid/LCD to a comfortable viewing angle.
4. Press the power button to turn “On”.

Battery

The battery allows you to use your computer while you are on the road or when an electrical outlet is unavailable. Battery life varies depending on the applications and the configuration you're using. **To increase battery life, let the battery discharge completely before recharging** (see *“How do I completely discharge the battery?” on page 3 - 12*).

We recommend that you do not remove the battery. For more information on the battery, please refer to *“Battery Information” on page 3 - 9*.

Turning on the Computer

Now you are ready to begin using your computer. To turn it on simply press the power button on the front panel.

When the computer is on, you can use the power button as a Standby/Hibernate/Shutdown hot-key button when it is pressed for less than **4 seconds** (pressing and holding the power button for longer than this will shut the computer down). Use **Power Options** in the *Windows* control panel to configure this feature.



Shutdown

Note that you should always shut your computer down by choosing the **Turn Off Computer** command from the **Start** menu in *Windows*. This will help prevent hard disk or system problems.



Forced Off

If the system “hangs”, and the **Ctrl + Alt + Del** key combination doesn’t work, press the power button for **4 seconds**, or longer, to force the system to turn itself off.

Power Button as Standby or Hibernate Button

If you are using a fully ACPI-compliant OS, (such as Windows XP) you can use the OS’s “Power Options” control panel to set the power button to send the system into Standby or Hibernate mode (see your OS’s documentation, or *“Configuring the Power Button” on page 3 - 8* for details).

Resuming Operation

The system can resume from Monitor or Hard Disk Standby by pressing the **Sleep/Resume** key combination (**Fn + F4**), or power button.

Figure 3 - 1
Power Schemes

Power Schemes

You can set your computer to conserve power through individual components by means of **Power Schemes**. You can also adjust the settings for each scheme to set the monitor to turn off after a specified time, and the computer's hard disk motor to turn off if the hard disk drive has not been accessed for a specified period of time (if the system reads or writes data, the hard disk motor will be turned back on). The schemes may also be set to set a specified time for the system to enter **Standby** or **Hibernate** modes (see *“System Power Options” on page 3 - 6*).

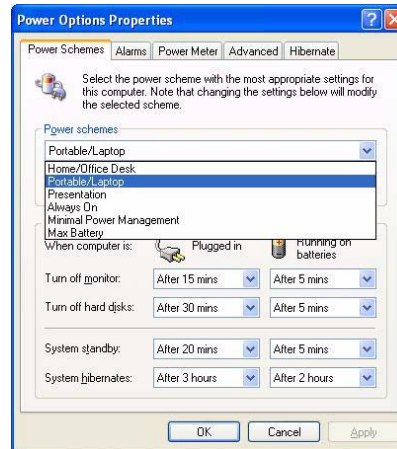

Each **Windows Power Scheme** will also adjust the processor performance of your machine in order to save power. This is worth bearing in mind if you are experiencing any reduced performance (especially under DC/battery power).

Choose the **Home/Office Desk** scheme for maximum performance when the computer is powered from an AC power source. Choose the **Max Battery** scheme (bear in mind that this scheme may slow down the overall performance of the computer in order to save power) for maximum power saving when the computer is battery (DC power) powered. **Windows** will use **Portable/Laptop** as the default scheme.

Windows will use **Portable/Laptop** as the default scheme.

System Power Options

You can use the system power options to stop the computer's operation and restart where you left off. This system features **Standby** and **Hibernate** sleep mode levels (**Hibernate** mode will need to be enabled by clicking the option in the **Hibernate** tab in the **Power Options** control panel - *Figure 3 - 2 on page 3 - 7*).

Hibernate Mode vs. Shutdown

Hibernate mode and Shutdown are the same in that the system is off and you need to press the power button to turn it on. Their main difference is:

When you come back from hibernation, you can return to where you last left off (what was on your desktop) without reopening the application(s) and file(s) you last used.

You can use either method depending on your needs.

Standby Mode vs. Hibernate Mode

If you want to stay away from your work for just a while, you can put the system on standby instead of in hibernation. It takes a longer time to wake up the system from **Hibernate** mode than from **Standby** mode.

Standby

Standby saves the least amount of power, but takes the shortest time to return to full operation. During Standby the hard disk is turned off, and the CPU is made to idle at its slowest speed. All open applications are retained in memory. When you are not using your computer for a certain length of time, which you specify in the operating system, it will enter Standby mode to save power.

Hibernate

Hibernate uses no power and saves all of your information on a part of the HDD before it turns the system off. Although it saves the most power it takes the longest time to return to full operation. You can set your computer to automatically enter Hibernate mode when the battery power is almost depleted. You will need to enable Hibernate mode from the **Hibernate** tab in the Power Options control panel. **The system will resume from Hibernate mode by pressing the power button.**

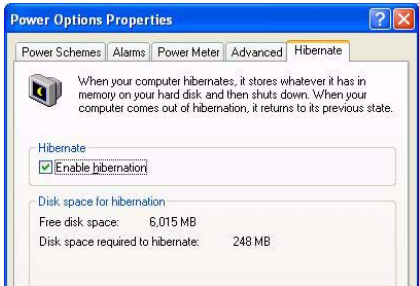

System Resume

The system can resume from Standby mode by:

- Pressing the power button
- An alarm resume that is enabled and expires
- An incoming call received on the modem (if enabled)
- Network card activity (if enabled)

Figure 3 - 2
Enable Hibernation

Configuring the Power Button

The power button may be set to send the computer in to either **Standby** or **Hibernate** mode (*Figure 3 - 3*). In **Standby** mode, the LED  will flash green. In **Hibernate** mode the LED will be off (battery) or orange (AC/DC adapter). If you are in a power saving mode set to save power through individual components (e.g. hard disk, monitor), the LED will remain green.

Figure 3 - 3
Power Options
(Advanced - Power Buttons)



Power Button

Lid

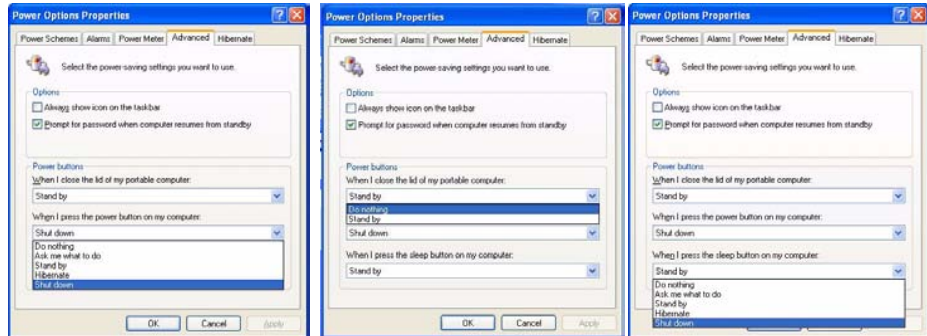
Sleep/Resume (Sleep) Button



Sleep Button

You may also configure the **Sleep/Resume** key combination (**Fn + F4**) from the menu illustrated in *Figure 3 - 3*. In **Windows** this is referred to as the **Sleep** button.

Battery Information

Please follow these simple guidelines to get the best use out of your battery.

New Battery

Always completely discharge, then fully charge, a new battery (see *“Battery FAQ” on page 3 - 12* for instructions on how to do this).

Battery Life

Your computer’s battery life is dependent upon many factors, including the programs you are running, and peripheral devices attached. **Power Options** (you may set low battery **Alarms** and actions, and check the **Power Meter** from the **Power Options** control panel), and settings in the OS will help prolong the battery life if configured appropriately.

Low Battery Warning

When the battery is critically low, immediately connect the AC/DC adapter to the computer or save your work, otherwise, the unsaved data will be lost when the power is depleted.

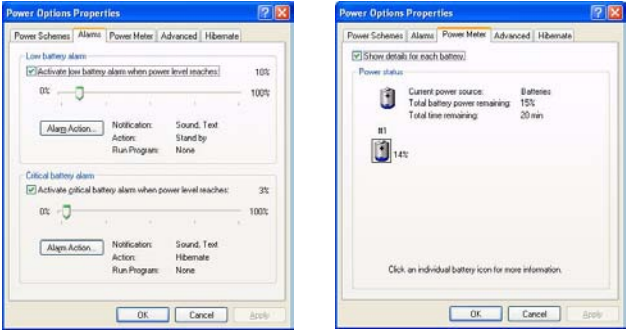

Figure 3 - 4
Power Options
(Alarm & Power
Meter)



Conserving Battery Power

To conserve battery power:

Lower the brightness level of the LCD display. The system will decrease LCD brightness slightly to save power when it is not powered by the AC/DC adapter.

Close modem or communication applications when they are not being used.

Remove any unused PC Cards from the computer (PC Cards quickly use up battery power even if the system enters sleep mode).

Disconnect any unnecessary external devices.

Battery life may be shortened through improper maintenance. **To optimize the life and improve its performance, fully discharge and recharge the battery at least once every 30 days.**

We recommend that you do not remove the battery yourself. If you do need to remove the battery for any reason see *“Removing the Battery” on page 6 - 3.*

Recharging the Battery with the AC/DC Adapter

The battery pack automatically recharges when the AC/DC adapter is attached and plugged into an electrical outlet. If the computer is powered on, and in use, it will take several hours to fully recharge the battery. When the computer is turned off but plugged into an electrical outlet, battery charge time is less. (Refer to *“LED Indicators” on page 1 - 9* for information on the battery charge status, and to *“Battery Information” on page 3 - 9* for more information on how to maintain and properly recharge the battery pack.)

Proper handling of the Battery Pack

- DO NOT disassemble the battery pack under any circumstances
- DO NOT expose the battery to fire or high temperatures, it may explode
- DO NOT connect the metal terminals (+, -) to each other



Damaged Battery Warning

Should you notice any physical defects (e.g. the battery is bent out of shape after being dropped), or any unusual smells emanating from the notebook battery, shut your computer down immediately and contact your service center. If the battery has been dropped we do not recommend using it any further, as even if the computer continues to work with a damaged battery in place, it may cause circuit damage, which may possibly result in fire. It is recommended that you replace your computer battery every two years.



Caution

Danger of explosion if battery is incorrectly replaced.

Replace only with the same or equivalent type recommended by the manufacturer. Discard used battery according to the manufacturer's instructions.

Battery FAQ

How do I completely discharge the battery?

Use the computer with battery power until it shuts down due to a low battery. Don't turn off the computer by yourself even when you see a message that indicates the battery is critically low, just let the computer use up all of the battery power and shut down on its own. Disable the **Power Options** functions in the **Control Panel**, especially any **Alarms** (uncheck the tickboxes - see [3 - 9](#)) and **Schemes** (change all the settings to **Never** - see page [3 - 4](#)). As the battery nears the end of its life save and close any critical files.

How do I fully charge the battery?

When charging the battery, don't stop until the LED charging indicator light changes from orange to green.

How do I maintain the battery?

Completely discharge and charge the battery at least once every 30 days or after about 20 partial discharges.

Swap Battery (Optional)

If you have included the **optional** swap battery in your purchase option (available as a an option for **Model A** computers only), it will allow you to change batteries on your computer without having to shut the computer down. The swap battery’s total operational time is about three minutes, however the swap battery life is dependent upon many factors, including the programs you are running, and peripheral devices attached.

The  icon will blink green for about one minute, and will then change to blink orange for a further two minutes before the computer shuts down. These times are intended as guidelines only, and may vary depending upon programs and peripheral devices being used.

Icon	Color	Description
	Blinking Green	The Swap Battery is Operational
	Blinking Orange	The Swap Battery has Reached Critically Low Power Status

Table 3 - 1
LED Power Indicator

Chapter 4: Drivers & Utilities

This chapter deals with installing the drivers and utilities essential to the operation or improvement of some of the computer's subsystems. The system takes advantage of some newer hardware components for which the latest versions of most available operating systems haven't built in drivers and utilities. Thus, some of the system components won't be auto-configured with an appropriate driver or utility during operating system installation. Instead, you need to manually install some system-required drivers and utilities.

What to Install

The *Device Drivers & Utilities + User's Manual CD-ROM* contains the drivers and utilities necessary for the proper operation of the computer. (The **Wireless LAN**, optional **Bluetooth**, optional **PC Camera** and optional **Port Replicator** module drivers are on separate *CD-ROMs* supplied.) *Table 4 - 1, on page 4 - 6* lists what you need to install manually according to your choice of the operating system, and **it is very important that the drivers are installed in the order indicated.**

Module Driver Installation

The procedures for installing drivers for the **Wireless LAN**, **Bluetooth**, **PC Camera** and **Port Replicator** modules are provided in *"Modules & Options" on page 7 - 1*. Make sure that the drivers are installed in the order indicated in *Table 4 - 1, on page 4 - 6*.

Navigate (Browse..) to D:

You will notice that many of the instructions for driver installation require you to “**Navigate (Browse) to D:**”. We assume that you will install all drivers and utilities from the built-in CD device and it is assigned to “**Drive D:**”. In addition, all file extensions can be seen

In this case “D:” is the drive specified for your CD device. Not all computers are setup the same way, and some computers have the CD listed under a different drive letter - e.g. if you have two hard drives (or hard disk partitions) one may be designated as “Drive C:” and the other as “Drive D:”. In this case the CD device may be designated as “Drive E:” - Please make sure you are actually navigating to the correct drive letter for the CD device.

When you click the **Browse** (button) after clicking **Run** in the **Start** menu you will see the “**Look in:**” dialog box at the top of the **Browse** window. Click the scroll button to navigate to **My Computer** to display the devices and drive letters.

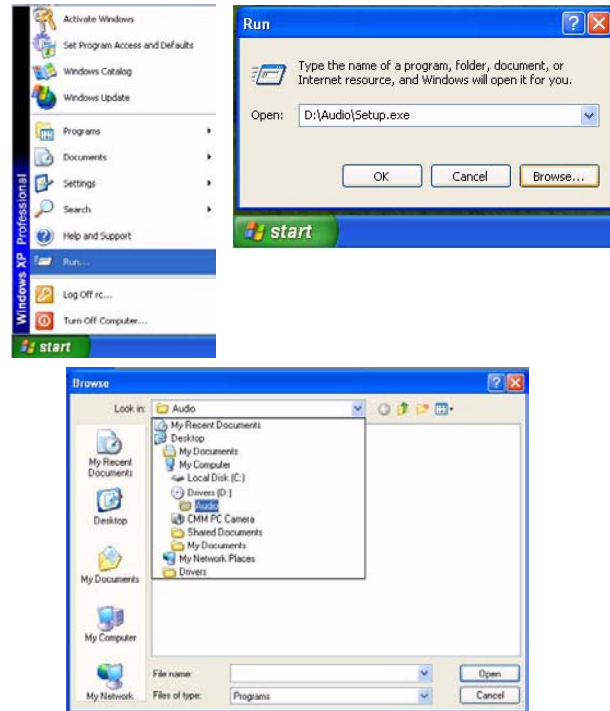

Figure 4 - 1 - Navigate (Browse..) to..

Service Packs

Check the warnings on the following pages regarding installation of the appropriate **Service Pack** for your *Windows* OS. Make sure you have installed the appropriate Service Pack **before** installing all the drivers.



Service Pack Installed

To see which **Service Pack** is currently installed on your computer go to the **General** tab of the **System** control panel. Right-click the **My Computer** icon on the desktop or in the **Start** menu and select **Properties**. The Service Pack currently installed on your system will be listed under the “**System:**” heading. (If no Service Pack information is listed, then no Service Pack is installed.)



Windows XP Service Pack 2

Make sure you install **Windows XP Service Pack 2** (or a Windows XP version which includes Service Pack 2) **before installing any drivers**. Service Pack 2 includes support for **USB 2.0**.

If you have **upgraded** the system by installing **Service Pack 2** (i.e. your Windows XP version does not include Service Pack 2) then follow these instructions:

1. Click **Start** (menu), point to **Settings** and click **Control Panel** (or click **Control Panel**).
2. Double-click **System** (icon); **System** (icon) is in **Performance and Maintenance** (category).
3. Click the **Hardware** (tab) > **Device Manager** (button).
4. Click “+” next to **Other Devices** (if its sub-items are not shown).
5. Right-click **Universal Serial Bus (USB) Controller** and select **Uninstall** > **OK** (if you don’t see the item then there is no need to take any further action).
6. Restart the computer and it will find the USB 2.0 controller.

Authorized Driver Message

If you receive a message telling you that the driver you are installing is not authorized (**Digital Signature Not Found**), just click **Yes** or **Continue Anyway** to ignore the message and continue the installation procedure.

You will receive this message in cases where the driver has been released after the version of *Windows* you are currently using. All the drivers provided will have already received certification for *Windows*.

Version Conflict Message

During driver installation if you encounter any “file version conflict” message, please click **Yes** to choose to keep the existing (newer) version.

Updating/Reinstalling Individual Drivers

If you wish to update/reinstall individual drivers it may be necessary to uninstall the original driver. To do this go to the **Control Panel** in the *Windows OS* and double-click the **Add/Remove Programs** item. **If you see the individual driver listed** (if not see below), uninstall it, following the on screen prompts (it may be necessary to restart the computer). Go to the appropriate section of the manual to complete the update/reinstall procedure for the driver in question.

If the driver is not listed in the **Add/Remove Programs** item:

1. Click **Start** (menu), point to **Settings** and click **Control Panel** (or click **Start > Control Panel**).
2. Double-click **System** (icon); System (icon) is in **Performance and Maintenance** (category).
3. Click **Hardware** (tab) > **Device Manager** (button).
4. Double-click the **device** you wish to update/reinstall the driver for (you may need to click “+”).
5. Look for the **Update Driver** button (check the **Driver** tab) and follow the on screen prompts.

Driver Installation

Insert the *Device Drivers & Utilities + User's Manual CD-ROM* and click **Install WinXP Drivers** (button).

If you wish to install the drivers manually see page 4 - 7.



Figure 4 - 2 - Drivers Installer Screen 1

1. Check the driver installation order from **Table 4 - 1 on page 4 - 6** (the drivers must be installed in this order) which is the same as that listed in the **Drivers Installer** menu below.
2. Click to select the driver you wish to install, after installing each driver it will become greyed out (if you need to reinstall any driver, click the **Unlock** button).
3. Follow the instructions for each individual driver installation procedure as listed on the following pages.



Figure 4 - 3 - Drivers Installer Screen 2

WinXP SP2 Driver	Page #
Install the appropriate Service Pack for WinXP	Page 4 - 3
Chipset	Page 4 - 8
Video	Page 4 - 8
Audio	Page 4 - 8
LAN	Page 4 - 9
Modem	Page 4 - 9
TouchPad	Page 4 - 10
PCMCIA/Card Reader	Page 4 - 10
Hot-Key	Page 4 - 11
AutoMail (Manual Driver Installation Only)	Page 4 - 11
Intel Wireless LAN	Page 7 - 3
Bluetooth	Page 7 - 4
PC Camera	Page 7 - 7
Port Replicator Serial Port	Page 7 - 14
Port Replicator Network (LAN) Port	Page 7 - 14

Table 4 - 1 - Driver Installation

Driver Installation Procedure

This section covers driver and utility installation instructions for *Windows XP Home & Professional*.

New Hardware Found

If you see the message “**New Hardware Found**” (**Found New Hardware Wizard**) during the installation procedure (other than when outlined in the driver install procedure), click **Cancel** to close the window, and follow the installation procedure as directed.

Service Pack Installation

Make sure you install the appropriate service pack for your operating system before installing any drivers (see “*Windows XP Service Pack 2*” on [page 4 - 3](#)).

Manual Driver Installation

If you wish to install the drivers manually, click the **Exit** button to quit the *Drivers Installer* application, then follow the manual installation procedure for each driver. The manual installation procedure begins with instructions on how to browse to the executable file; “Click **Start** (menu) > **Run..**”.

New Hardware Found

If you see the message “**New Hardware Found**” (**Found New Hardware Wizard**) during the installation procedure (other than when outlined in the driver install procedure), click **Cancel** to close the window, and follow the installation procedure as directed.

Chipset (WinXP)

1. Click **1.Install Chipset Driver** > **Yes** from the Drivers Installer menu.
OR
Click **Start** (menu) > **Run...** and navigate (**Browse..**) to **D:\Drivers\Chipset\Setup.exe** and click **OK**.
2. Click **Next** > **Yes** > **Next**.
3. Click **Finish** to restart the computer.

Video (WinXP)

1. Click **2.Install Video Driver** > **Yes** from the Drivers Installer menu.
OR
Navigate (**Browse..**) to **D:\Drivers\Video\Setup.exe** and click **OK**.
2. Click **Next** > **Yes**.
3. Click **Finish** to restart the computer.

Audio (WinXP)

1. Click **3.Install Audio Driver** > **Yes** from the Drivers Installer menu.
OR
Navigate (**Browse..**) to **D:\Drivers\Audio\Setup.exe** and click **OK**.
2. Click **Next**.
3. Click **Finish** to restart the computer.
4. When the computer restarts click **Cancel** if the *The Found New Hardware Wizard* appears (click **Continue Anyway** if asked if you want to continue at any time).
5. Click **Yes** to restart the computer (click **Cancel** if *The Found New Hardware Wizard* appears after restart).

LAN (WinXP)

1. Click **4.Install LAN Driver** > **Yes** from the Drivers Installer menu.
OR
Click **Start** (menu) > **Run...** and navigate (**Browse...**) to **D:\Drivers\LAN\Setup.exe** and click **OK**.
2. To continue click **Next**.
3. Click **Finish**.
4. The network settings can now be configured.

Modem (WinXP)

1. Click **5.Install Modem Driver** > **Yes** from the Drivers Installer menu.
OR
Click **Start** (menu) > **Run...** and navigate (**Browse...**) to **|D:\Drivers\Modem\ssetup.exe** and click **OK** (click **Continue Anyway** if asked if you want to continue at any time).
2. Click **OK**.
3. The modem is ready for dial-up configuration.



Modem Country Selection

Be sure to check if the modem country selection is appropriate for you (**Control Panel** > **Phone and Modem Options**).

TouchPad (WinXP)

1. Click **6.Install TouchPad Driver > Yes** from the Drivers Installer menu.
OR
Click **Start** (menu) > **Run...** and navigate (**Browse..**) to **D:\Drivers\TouchPad\SETUP.EXE** and click **OK**.
2. Click **Next > Next** (click **Continue Anyway** if asked if you want to continue at any time).
3. Click **Finish** to restart the computer.
4. You may then configure your TouchPad as outlined in *“TouchPad and Buttons/Mouse” on page 2 - 11*.

PCMCIA/Card Reader (WinXP)

1. Click **7.Install PCMCIA Driver > Yes** from the Drivers Installer menu.
OR
Click **Start** (menu) > **Run...** and navigate (**Browse...**) to **D:\Drivers\PCMCIA\Setup.exe** and click **OK**.
2. Click **Next > Next**.
3. Click **Finish** to restart the computer.

Hot-Key (WinXP)

1. Click **8.Install Hotkey Utility > Yes** from the Drivers Installer menu.
OR
Click **Start** (menu) > **Run...** and navigate (**Browse..**) to **D:\Drivers\Hotkey\Setup.exe** and click **OK**.
2. Choose the language you prefer, and click **OK**.
3. Click **Next**.
4. Click **Finish** to restart your computer.
5. See *“Application Hot-Key” on page 2 - 10* for configuration instructions.

AutoMail (WinXP)

The AutoMail Driver must be installed manually as per the instructions below:

1. Click **Start** (menu) > **Run...** and navigate (**Browse..**) to **D:\Drivers\AUTOMAIL\SETUP.EXE** and click **OK**.
2. To continue click **Next > Next > Finish**.
3. For further details see *“Auto Mail Checker” on page 2 - 8*.

Wireless LAN

See the introduction in *“Intel PRO/Wireless Mini-PCI WLAN Module” on page 7 - 2*, and check the install procedure for your appropriate module and operating system.

Bluetooth

See install procedure in *“Bluetooth Module” on page 7 - 4*.

PC Camera

See install procedure in *“Sertek PC Camera Driver Installation (WinXP)” on page 7 - 7*.

Port Replicator

See install procedure in *“Port Replicator Serial (COM) Port Driver (WinXP)” on page 7 - 14* and *“Port Replicator Network (LAN) Driver (WinXP)” on page 7 - 14*.

Chapter 5: BIOS Utilities

Overview

This chapter gives a brief introduction to the computer's built-in software:

Diagnostics: The **POST** (Power-On Self Test)

Configuration: The *Setup* utility

If your computer has never been set up, or you are making important changes to the system (e.g. hard disk setup), then you should review this chapter first and note the original settings found in *Setup*. Even if you are a beginner, keep a record of the settings you find and any changes you make. This information could be useful if your system ever needs servicing.

There is one general rule: *Don't make any changes unless you are sure of what you are doing*. Many of the settings are required by the system, and changing them could cause it to become unstable or worse. If you have any doubts, consult your service representative.



BIOS Settings Warning

Incorrect settings can cause your system to malfunction. To correct mistakes, return to *Setup* and restore the *Setup Defaults* with `<F9>`.



POST Screen

1. BIOS information
2. CPU type
3. Memory status
4. Enter **Setup** prompt appears only during POST

Note: The **POST** screen as pictured is for guideline purposes only. The **POST** screen on your computer may appear slightly different.

Figure 5 - 1
POST Screen

The Power-On Self Test (POST)

Each time you turn on the computer, the system takes a few seconds to conduct a **POST**, including a quick test of the on-board RAM (memory).

As the **POST** proceeds, the computer will tell you if there is anything wrong. If there is a problem that prevents the system from booting, it will display a system summary and prompt you to run **Setup**.

If there are no problems, the **Setup** prompt will disappear and the system will load the operating system. Once that starts, you can't get into **Setup** without rebooting.

```

Phoenix NoteBIOS 4.0 Release 6.1 ①
Copyright 1985-2003 Phoenix Technologies Ltd.
All Rights Reserved
Bios Ver: M5x0G - D.00.04
KBC Ver: 1.00.D2

CPU = Intel(R) Pentium(R) M processor 1.73GHz ②
1015M System RAM Passed ③
2048K Cache SRAM Passed
System BIOS shadowed
Video BIOS shadowed
Fixed Disk 0: TOSHIBA MK3025GAS
ATAPI CD-ROM: TSSTcorpCD/DVDW TS-L532A
USB: Y-E DATA USB-FDU
Mouse initialized

Press <F2> to enter SETUP ④
  
```

Failing the POST

Errors can be detected during the **POST**. There are two categories, “fatal” and “non-fatal”.

Fatal Errors

These stop the boot process and usually indicate there is something seriously wrong with your system. Take the computer to your service representative or authorized service center as soon as possible.

Non-Fatal Errors

This kind of error still allows you to boot. You will get a message identifying the problem (make a note of this message!) followed by the prompt:

- Press <F1> to resume
- <F2> to enter Setup

Press **F1** to see if the boot process can continue. It may work, without the correct configuration.

Press **F2** to run the **Setup** program and try to correct the problem. If you still get an error message after you change the setting, or if the “cure” seems even worse, call for help.

The Setup Program

The **Phoenix Setup** program tells the system how to configure itself and manage basic features and subsystems (e.g. port configuration).

Entering Setup

To enter *Setup*, turn on the computer and press **F2** during the **POST**. The prompt (*Press F2 to Enter Setup*) seen in *Figure 5 - 1* is usually present for a few seconds after you turn on the system. If you get a “Keyboard Error”, (usually because you pressed **F2** too quickly) just press **F2** again.

If the computer is already on, reboot using the **Ctrl + Alt + Delete** combination and then hold down **F2** when prompted. The *Setup* main menu will appear.

Setup Screens

The following pages contain additional advice on **portions** of the *Setup*.

Along the top of the screen is a menu bar with five (5) menu headings. When you select a heading, a new screen appears. Scroll through the features listed on each screen to make changes to *Setup*.

Instructions on how to navigate each screen are in the box along the bottom of the screen. If these tools are confusing, press **F1** to call up a **General Help** screen, then use the arrow keys to scroll up or down the page.

The **Item Specific Help** on the right side of each screen explains the highlighted item and has useful messages about its options.

If you see an arrow ► next to an item, press **Enter** to go to a sub-menu on that subject. The sub-menu screen that appears has a similar layout, but the **Enter** key may execute a command.



Setup Menu

The **Setup** menus shown in this section are for **reference** only. Your computer's menu will indicate the configuration appropriate for your model and options.

Main Menu

Figure 5 - 2
Main Menu

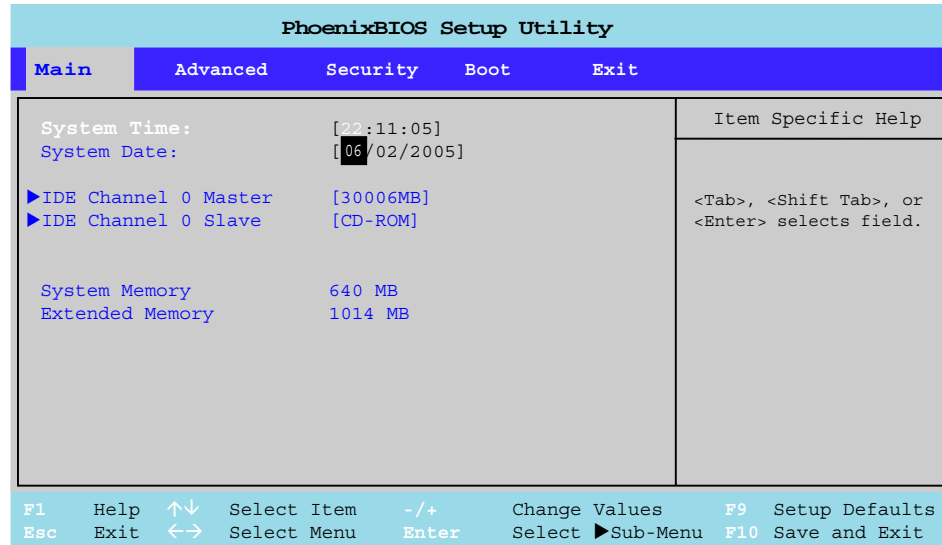

System Time & Date (Main Menu)

The hour setting uses the 24-hour system (i.e., 00 = midnight; 13 = 1 pm). If you can change the date and time settings in your operating system, you will also change these settings. Some applications may also alter data files to reflect these changes.

IDE Channel 0 Master/Slave (Main Menu)

Pressing **Enter** opens the sub-menu to show the configuration of either a CD Device or HDD that on the computer's IDE Channel 0. Use the **Auto** (Type:) setting to have the items configured automatically for you.

System/Extended Memory (Main Menu)

This item contain information on the system memory, and is not user configurable. The system will auto detect the amount of memory installed.

Advanced Menu

Figure 5 - 3
Advanced Menu

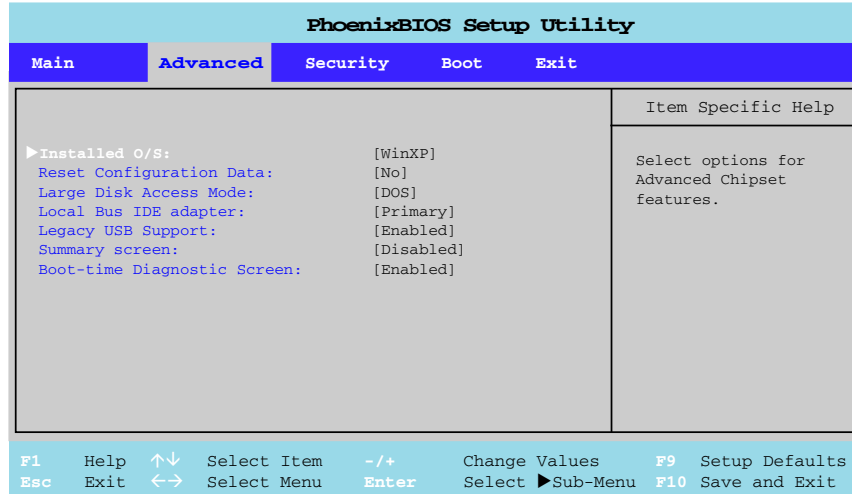

Installed O/S: (Advanced Menu)

This setting tells the computer what kind of operating system you're using.

Note: Windows XP is a Plug'n'Play (PNP) OS's.

Reset Configuration Data (Advanced Menu)

This item is set to **No** as default. You can change the setting to **Yes** if you have installed a new add-on which has reconfigured the system, resulting in such a serious system conflict that the operating system is unable to boot.

Large Disk Access Mode (Advanced Menu)

Select “**Other**” if you are using systems such as Novell, UNIX etc. Select “**DOS**” (default) if you are using Windows.

Local Bus IDE adapter (Advanced Menu)

This item allows you to enable or disable support for the local bus IDE adapter (the interface for the hard disk and CD devices).

Legacy USB Support (Advanced Menu)

Use this menu item to enable/disable the support for Legacy Universal Serial Bus.

Summary Screen: (Advanced Menu)

Enable this option to display the system configuration as the computer boots up.

Boot-time Diagnostic Screen: (Advanced Menu)

Use this menu item to enable/disable the display on the boot-time Diagnostic Screen.

Security Menu

Figure 5 - 4
Security Menu

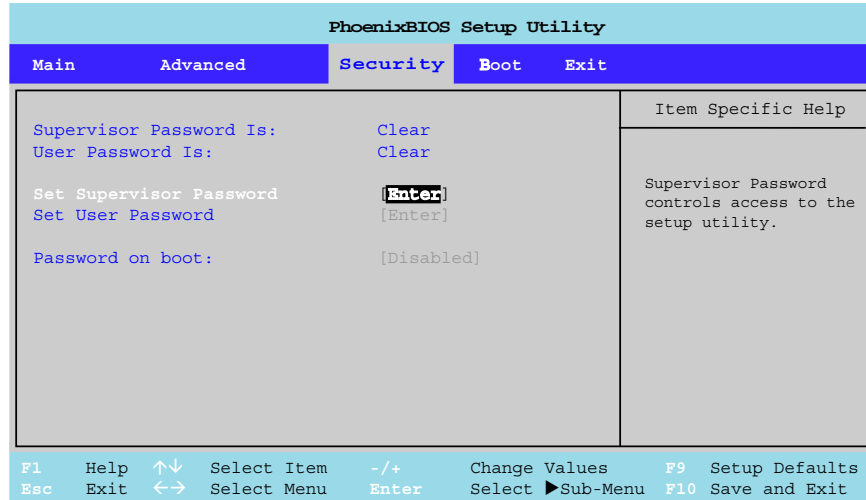

Security Menu

The changes you make here affect the access to the **Setup** utility itself, and also access to your machine as it boots up after you turn it on. These settings do not affect your machine or network passwords which will be set in your software OS.

Set Supervisor Password (Security Menu)

You can set a password for access to the **Setup** utility. This will not affect access to the computer OS, (only the **Setup** utility) unless you choose to set a **Password on Boot** (see over).

Set User Password (Security Menu)

You can set a password for **user mode** access to the Setup utility. This will not affect access to the computer OS, (only the Setup utility) unless you choose to set a Password on Boot (see below). Many menu items in the Setup utility cannot be modified in **user mode**. You can only set the user password after you have set the supervisor password.

Password on boot: (Security Menu)

Specify whether or not a password (supervisor or user password) should be entered to boot the computer. If “**Enabled**” is selected, only users who enter a correct password can boot the system (see the warning in the sidebar). The default setting is “**Disabled**”.

Note: To clear existing passwords press **Enter** and type the existing password, then press **Enter** for the new password (without typing any password entry) and **Enter** again to confirm the password clearance.



Password Warning

If you set a boot password (Password on boot is “Enabled”), **NEVER** forget your password.

The consequences of this could be serious. If you cannot remember your boot password you must contact your vendor and you may lose all of the information on your hard disk.

Boot Menu

Figure 5 - 5
Boot Menu

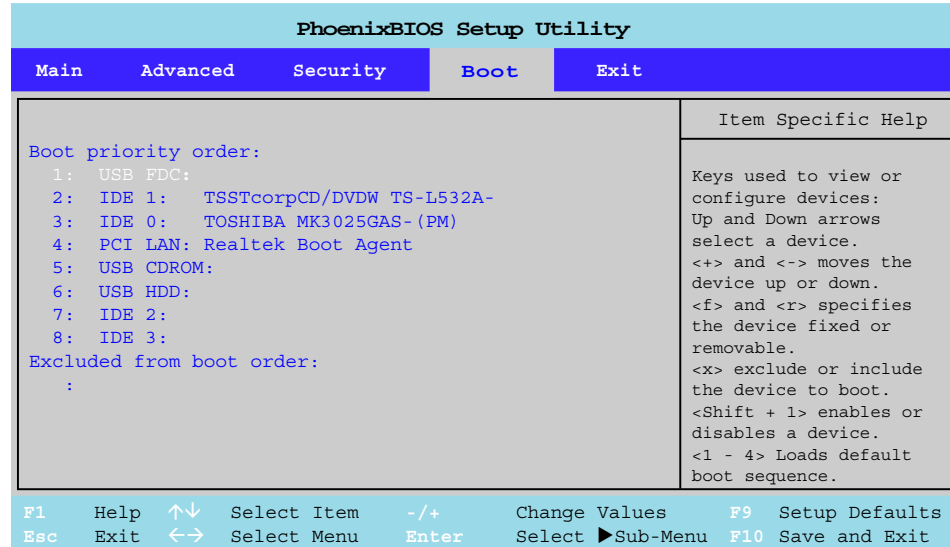

When you turn the computer on it will look for an operating system (e.g. **WindowsXP**) from the devices listed in this menu, and **in this priority order**. If it cannot find the operating system on that device, it will try to load it from the next device in the order specified in the **Boot priority order**. Item specific help on the right is available to help you move devices up and down the order.

Boot devices usually are hard drives, floppy drives, and CD-ROMs/DVD-ROMs and Networks (LANs).

When you specify a device as a boot device on the **Boot Menu**, it requires the availability of an operating system on that device. Most home computers come with an operating system already installed on “Drive C:”.

If you wish to boot from a CD-ROM/DVD-ROM you will need to add it to the boot order. As a general rule the order below is recommended:

1. Removable Devices (usually floppy disks)
2. CD-ROM/DVD-ROM Drive
3. Hard Drive
4. LAN

In everyday use you will usually boot from the hard drive, however there may be occasions when it is advantageous to boot from a floppy disk or CD-ROM/DVD-ROM.

Exit Menu

Figure 5 - 6
Exit Menu

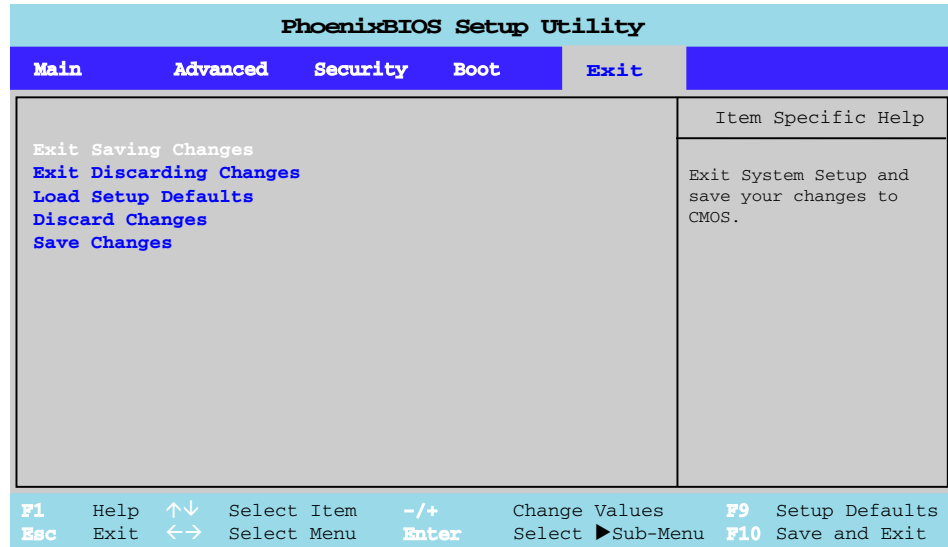

Choosing to *Discard Changes*, or *Exit Discarding Changes*, will wipe out any changes you have made to the *Setup*. You can also choose to restore the original *Setup* defaults that will return the *Setup* to its original state, and erase any previous changes you have made in a previous session.

Chapter 6: Upgrading The Computer

Overview

This chapter contains information on upgrading the computer. Follow the steps outlined to make the desired upgrades. If you have any trouble or problems you can contact your service representative for further help. Before you begin you will need:

- A small crosshead or Phillips screwdriver
- A small regular slotted (flathead) screwdriver
- An antistatic wrist strap

Before working with the internal components you will need to wear an anti-static wrist strap to ground yourself because static electricity may damage the components.

The chapter includes:

- Removing the Battery
- Upgrading the Hard Disk Drive
- Upgrading the Optical (CD/DVD) Device
- Upgrading the System Memory (RAM)

Please make sure that you review each procedure before you perform it.



Warranty Warning

Please check with your service representative before undertaking any upgrade procedures to find out if this will VOID your warranty.



Power Safety Warning

Before you undertake any upgrade procedures, make sure that you have turned off the power, and disconnected all peripherals and cables (including telephone lines). It is advisable to also remove your battery in order to prevent accidentally turning the machine on.

When Not to Upgrade

These procedures involve opening the system's case, adding and sometimes replacing parts.

You should **not** perform any of these upgrades if:

- Your system is still under warranty or a service contract
- You don't have all the necessary equipment
- You're not in the correct environment
- You doubt your abilities

Under any of these conditions, contact your service representative to purchase or replace the component(s).



Removal Warning

When removing any cover(s) and screw(s) for the purposes of device upgrade, remember to replace the cover(s) and screw(s) before turning the computer on.

Removing the Battery

If you are confident in undertaking upgrade procedures yourself, for safety reasons it is best to remove the battery.

1. Turn the computer **off**, and turn it over.
2. Slide the latch **1** in the direction of the arrow, and hold it in place.
3. Slide the battery in the direction of the arrow **2**.

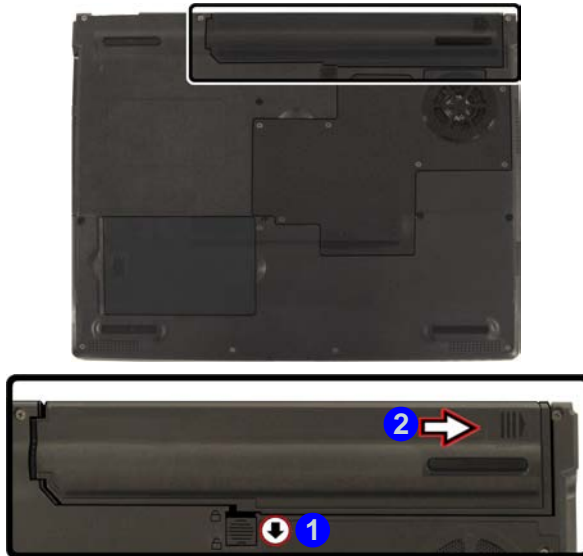

Warranty Warning

Please check with your service representative before undertaking any upgrade procedures to find out if this will VOID your warranty.

Figure 6 - 1
Battery Latch

Upgrading The Computer

- Lift the battery out in the direction of the arrow **3**.

Figure 6 - 2
Battery Up

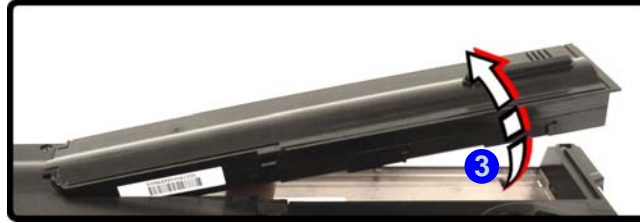

- Lift the battery **4** out.

Figure 6 - 3
Battery Out

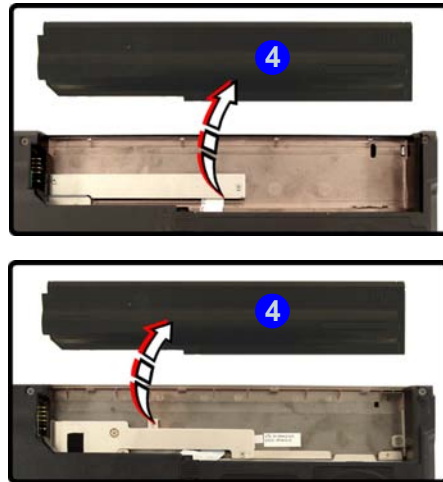

Upgrading the Hard Disk Drive

The hard disk drive can be taken out to accommodate other 2.5" parallel (PATA) hard disk drives with a height of 9.5mm (h) (see *“Storage” on page C - 3*). Follow your operating system’s installation instructions, and install all necessary drivers and utilities (as outlined in *“Driver Installation” on page 4 - 5*), when setting up a new hard disk.

1. Turn **off** the computer, and turn it over and remove the battery.
2. Locate the hard disk bay cover and remove screws **1** **Model A** OR screws **2** - **3** **Model B**.

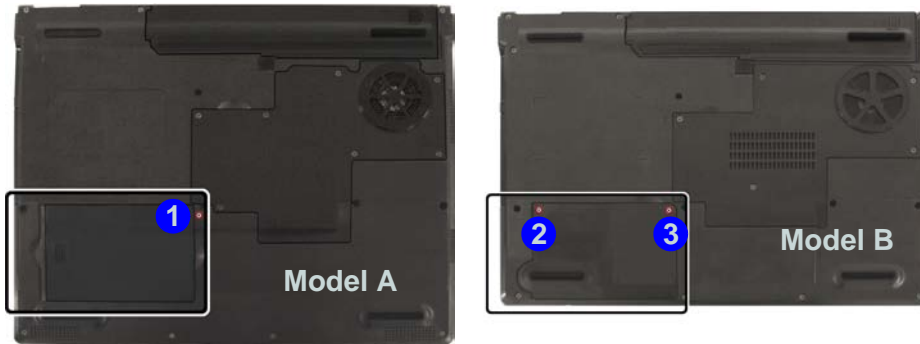

HDD System Warning

New HDD's are blank. Before you begin make sure:

You have backed up any data you want to keep from your old HDD.

You have all the CD-ROMs and FDDs required to install your operating system and programs.

If you have access to the internet, download the latest application and hardware driver updates for the operating system you plan to install. Copy these to a removable medium.

Figure 6 - 4
Hard Disk Bay &
Screws

Upgrading The Computer

For **Model A** computers (*see overleaf for Model B*):

3. Slide the hard disk and cover assembly in the direction of arrow **4**.
4. Lift the hard disk and cover assembly in the direction of arrow **5**.
5. Remove the hard disk and cover assembly **6**.
6. Remove the 4 screws to release the hard disk from the assembly cover, and reverse the process to install any new hard disk.

Figure 6 - 5
**HDD & Cover
Assembly
Removal
(Model A
Computers Only)**

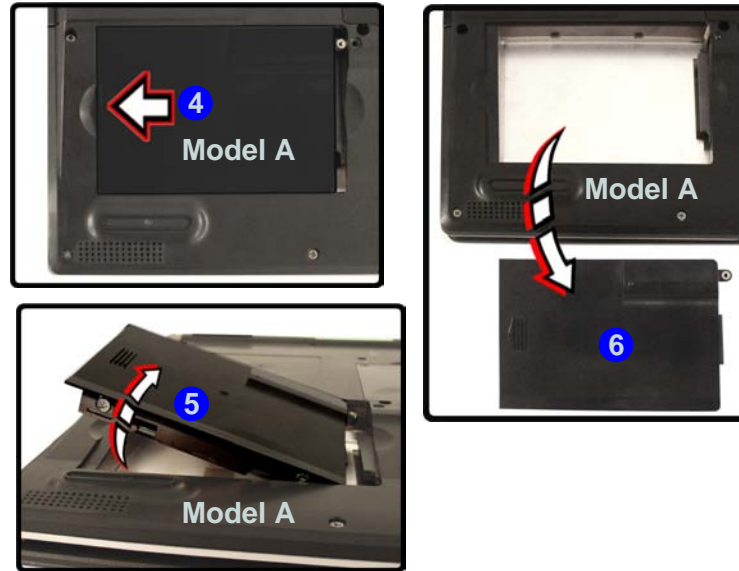

For **Model B** computers:

7. Pull the tab to slide the hard disk and case assembly in the direction of arrow **7**.
8. Lift the hard disk and case assembly out of the bay in the direction of arrow **8**.
9. Remove screws **9** - **10** to release the hard disk **11** from the case **12**, and reverse the process to install any new hard disk.

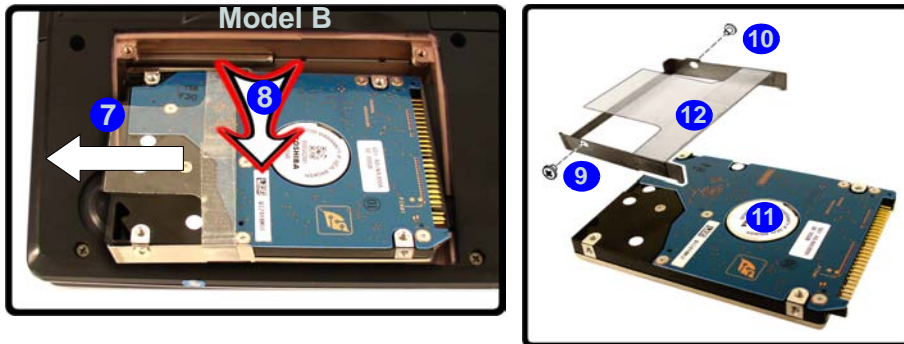
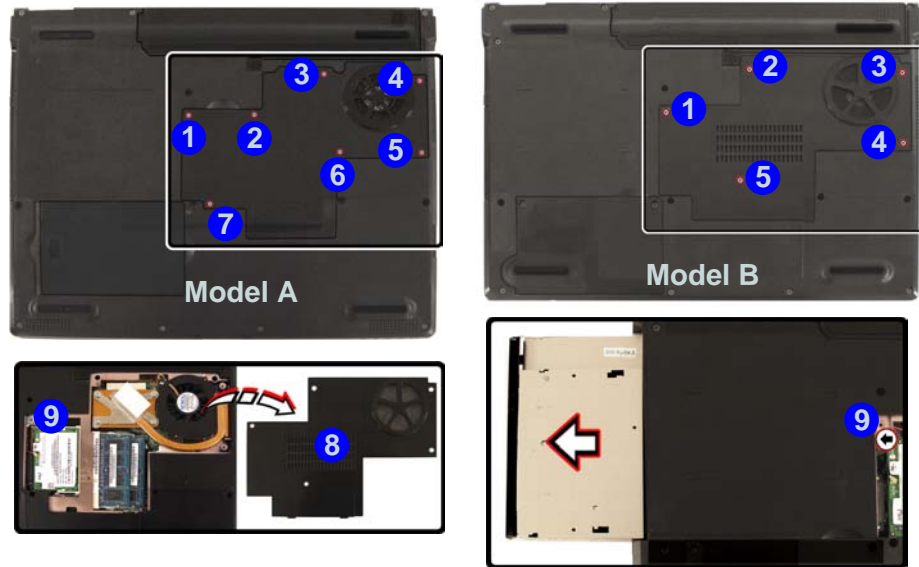

Figure 6 - 6
HDD & Case
Assembly
Removal
(Model B
Computers Only)

Upgrading the Optical (CD/DVD) Device

1. Turn **off** the computer, and turn it over and remove the battery.
2. Locate the memory bay cover and remove screws **1** - **7** (**Model A**)/ **1** - **5** (**Model B**).
3. Remove the bay cover **8**.
4. Use a screwdriver to carefully push out the optical device at point **9**.
5. Reverse the process to install the new device.

Figure 6 - 7
Removing the CD/
DVD Device



Upgrading the System Memory (RAM)

The computer has **two** memory sockets for 200 pin Small Outline Dual In-line (SO-DIMM) **DDRII (DDR2)** type memory modules (see *“Memory” on page C - 2* for details of supported module types).

The total memory size is automatically detected by the POST routine once you turn on your computer.

1. Turn **off** the computer, and turn it over and remove the battery.
2. Locate the memory bay cover and remove screws **1** - **7** (**Model A**)/ **1** - **5** (**Model B**).



Figure 6 - 8
RAM Bay Screws

Upgrading The Computer

Figure 6 - 9
RAM Cover
Removed



Contact Warning

Be careful not to touch the metal pins on the module's connecting edge. Even the cleanest hands have oils which can attract particles, and degrade the module's performance.

Figure 6 - 10
RAM Module
Location

3. Remove the bay cover **8**.

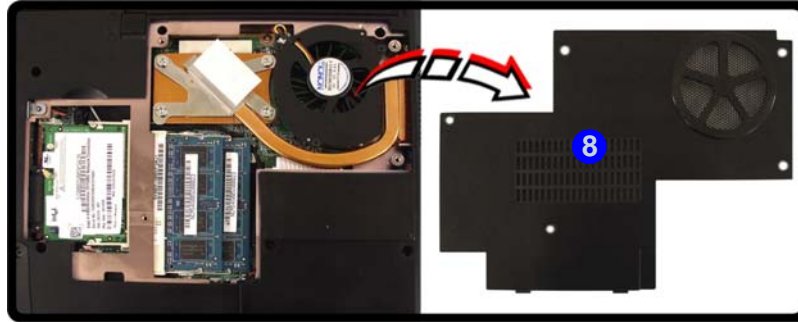

4. Gently pull the two release latches on the sides of the memory socket in the direction indicated by the arrows (**9** & **10**) in *Figure 6 - 10*.

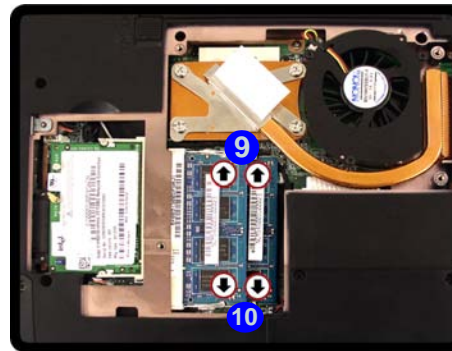

- The RAM module will 11 pop-up, and you can remove it.

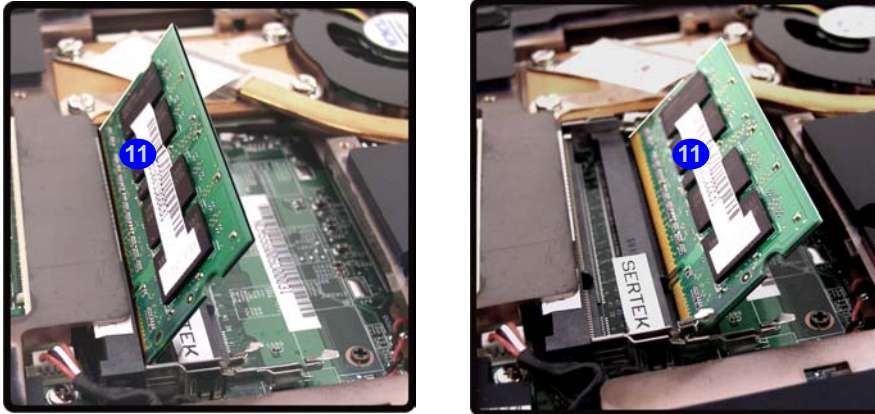

Figure 6 - 11
RAM Removal

- Pull the latches to release the second module if necessary.
- Insert a new module holding it at about a 30° angle and fit the connectors firmly into the memory slot.
- The module's pin alignment will allow it to only fit one way. Make sure the module is seated as far into the slot as it will go. **DO NOT FORCE** the module; it should fit without much pressure.
- Press the module in and down towards the mainboard until the slot levers click into place to secure the module.
- Replace the memory socket cover and the screw.
- Restart the computer to allow the BIOS to register the new memory configuration as it starts up.



Warranty

The CPU is not a user serviceable part. Opening this compartment, or accessing the CPU in any way, may violate your warranty.

Unauthorized tampering with the HDD may also violate your warranty.

Upgrading the Processor

If you want to upgrade your computer by replacing the existing processor with a faster/new one you will need to contact your customer service representative. We recommend that you do not do this yourself, since if it is done incorrectly you may damage the processor or mainboard.

Chapter 7: Modules & Options

Overview

This chapter contains the information on the **WLAN**, **Bluetooth**, **PC Camera** and **Port Replicator** modules which may come with your computer, depending on the configuration purchased. If you are unsure please contact your service representative.

The chapter includes information on the following:

- Intel PRO/Wireless Mini-PCI WLAN Module
- Bluetooth Module
- PC Camera
- Port Replicator



Wireless Device Operation Aboard Aircraft

The use of any portable electronic transmission devices aboard aircraft is usually prohibited. Make sure the module(s) are **OFF** if you are using the computer aboard aircraft.



Wireless Device Operation Aboard Aircraft

The use of any portable electronic transmission devices aboard aircraft is usually prohibited. Make sure the module(s) are OFF if you are using the computer aboard aircraft.

Use the **Fn + F11** key combination to toggle power to the WLAN module, and check the indicator to see if the module is powered on or not (see [Table 1 - 3, on page 1 - 9](#) [Table 1 - 5, on page 1 - 11](#)).

Figure 7 - 1
**Installation
Screens**

Intel PRO/Wireless Mini-PCI WLAN Module

If you have included an **Intel PRO/Wireless 2915ABG (802.11a/b/g)** Mini-PCI WLAN module in your purchase option, you will have the appropriate software CD provided for your module.

Before installing the **Intel PRO/Wireless 2915ABG** Mini-PCI WLAN driver, make sure that the Wireless LAN module is on (the  LED will be green). Use the **Fn + F11** key combination (see *“Function Keys” on page 1 - 11*) to toggle power to the Wireless LAN module (**make sure you install the drivers in the order indicated in [Table 4 - 1, on page 4 - 6](#)**).

To get help on the network settings you can view the **User Guide** from the *Intel PRO CD-ROM*.



Intel WLAN Driver Installation

1. Make sure the module is powered on, then insert the *Intel PROSet/ Wireless CD-ROM* into the CD/DVD drive.
2. Click **Install Software** (button).
3. Click the button to accept the license and click **Next > Next > OK**.
4. Click **OK** to complete the installation.
5. You can configure the settings by going to the **Intel (R) PROSet Wireless** control panel (**Start > Programs/All Programs > Intel PROSet Wireless**), or by double-clicking the taskbar icon .

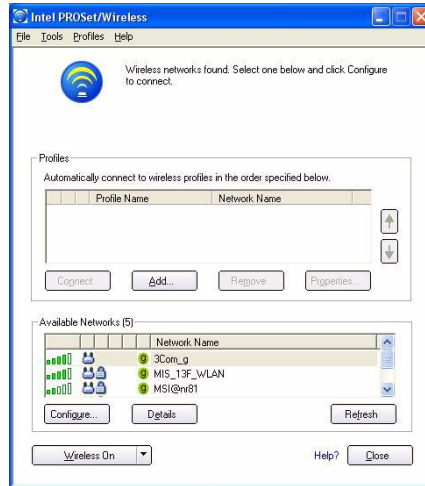

User Guide

You can view the User Guides by inserting the *Intel PROSet/ Wireless CD-ROM* and clicking **View User Guides** (button) as per *“Installation Screens” on page 7 - 2*.

Figure 7 - 2
Intel PROSet/
Wireless



Wireless Device Operation Aboard Aircraft

The use of any portable electronic transmission devices aboard aircraft is usually prohibited. Make sure the module(s) are OFF if you are using the computer aboard aircraft.

Use the **Fn + F12** key combination to toggle power to the optional Bluetooth module, and check the indicator to see if the module(s) is powered on or not (see [Table 1 - 3, on page 1 - 9](#)/[Table 1 - 5, on page 1 - 11](#)).

Bluetooth Module

If you have included an **Bluetooth** module in your purchase option, you will have the appropriate software CD provided for your module.

Before installing the **Bluetooth** driver, make sure that the optional Bluetooth module is on (the  LED will be orange). **Use the Fn + F12 key combination** (see [“Function Keys” on page 1 - 11](#)) **to toggle power to the Bluetooth module**. Make sure you install the drivers in the order indicated in [Table 4 - 1, on page 4 - 6](#).

Bluetooth Driver Installation

1. Make sure the module is powered on, then insert the **Bluetooth CD-ROM** into the CD/DVD drive.
2. The program will run automatically.
3. Choose the language you prefer, and click **OK**.
4. Click **Next > Yes > Next**.
5. Click **Finish** to restart the computer.
6. Click **OK** when the **Welcome to Bluetooth** screen appears on restart.
7. You can configure the settings by going to the **IVT Corporation BlueSoleil - Main Window** control panel (**Start > Programs/All Programs > IVT BlueSoleil**), or by clicking the taskbar icon .

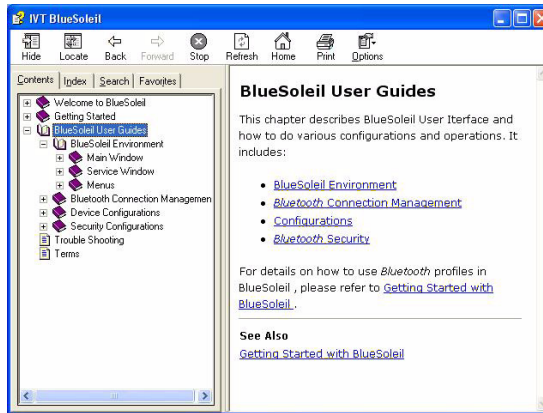
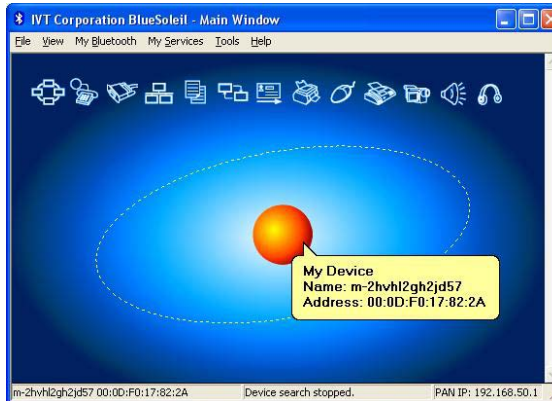

User Guide

View the BlueSoleil User Guides from the **Help** Menu (or press the **F1** key) in the **IVT Corporation BlueSoleil - Main Window** control panel. Click **BlueSoleil User Guides** in the **Contents** tab, and click to select the appropriate User Guide from the panel on the right.

Figure 7 - 3
Bluetooth Control Panel & User Guides



Taking Still Pictures

Double-click the **My Computer** icon on the desktop, or go the **Start** menu and point to **My Computer**, then click it.

Double-click the **BisonCam, NB Pro** icon.



Click **Take a new picture** in the **Camera Tasks** box.

PC Camera

If you have included an **PC Camera** module in your purchase option, you will have the appropriate software CD provided for your module.

Before installing the **PC Camera** driver, make sure that the optional PC Camera is on. Use the **Fn + F10 key combination** (see *“Function Keys” on page 1 - 11*) to toggle power to the **PC Camera module**. Make sure you install the drivers in the order indicated in *Table 4 - 1, on page 4 - 6*.

After installing the driver you can run the application software by going to the **CMM PC Camera** item in the **Start > Programs/All Programs** menu and selecting the **BisonCap** program.



Latest PC Camera Driver Information

Check the **PC Camera CD**, and any accompanying insert pages, for the latest updated information on the PC Camera driver, which may override the information provided here.

Sertek PC Camera Driver Installation (WinXP)

1. Press the **Fn + F10** key combination to power on the PC Camera module (click **Cancel** if you see a “**New Hardware Found**” message).
2. Insert the *PC Camera CD-ROM* into the CD/DVD drive.
3. The program will run automatically.
4. Click **Install Products**.
5. Choose the language you prefer and click **OK**.
6. Click **Next** (click **Continue Anyway** if asked if you want to continue).
7. When the *Found New Hardware Wizard* appears click the *No, not this time* button, and click **Next**.
8. Select *install the software automatically (Recommended)* and click **Next** (click **Continue Anyway** if asked if you want to continue).
9. Click **Finish** (in the *Found New Hardware Wizard*) > **Finish** (in the *InstallShield Wizard*) to restart the computer.
10. Run the **BisonCap** application program from the shortcut on the desktop, or from the **BisonCam** item in the **Start > Programs/All Programs** menu (if the hardware is turned off use the **Fn + F10** key combination to turn it on again).

PC Camera Audio Setup

If you wish to capture video & **audio** with your camera, it is necessary to setup the audio recording options in *Windows*.

1. Go to the **Start** menu and point to **Settings** (or just click **Control Panel**) and click **Control Panel**, then double-click the **Sounds & Audio Devices** icon (**Sounds, Speech, and Audio Devices** in Category View).
2. Click **Advanced** in the **Device volume** tab.
3. Click **Options** and scroll down and click **Properties**.
4. Select **Realtek HD Audio input** from the **Mixer Device** menu.
5. Click **Mic Volume** (check box) if it is not checked, then click **OK**.
6. Make sure the **Select** (check box) in the **Recording Control** panel, under the **Mic Volume** section, is checked (boost the volume as high as it will go).
7. Close the window, then click **OK**.
8. Run the **BisonCap** application program from the **Start > Programs/All Programs > BisonCam** menu.
9. Go to the **Devices** menu heading and select **Realtek HD Audio input** (it should have a tick alongside it).
10. Go to the **Capture** menu heading and select **Capture Audio** (it should have a tick alongside it).

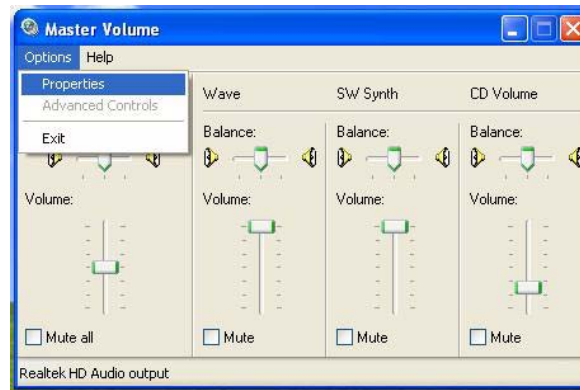
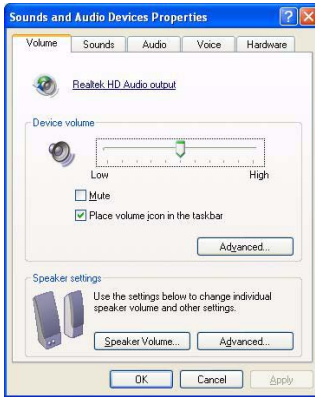
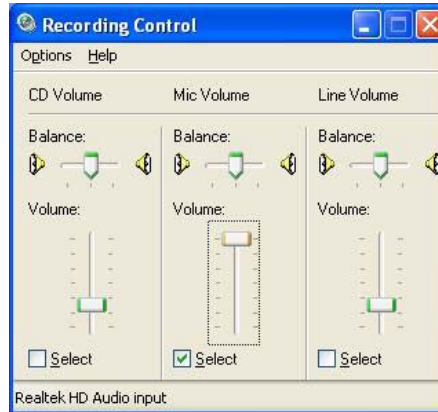
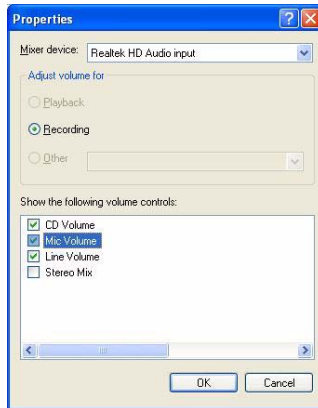

Figure 7 - 4
Audio Setup
(Windows XP)





Pre-Allocating File Space

You may pre-allocate the file size for the capture file in the **BisonCap** program. You can choose to ignore this by clicking **Cancel**.

Pre-allocating space on the hard disk can improve the capture quality (particularly of large capture files), by reducing the amount of work the hard disk has to do in finding space for the video data as it is being captured.

You may find it helpful to defragment the HDD before capture.

BisonCap

BisonCap is a video viewer useful for general purpose video viewing and testing, and can capture video files to .avi format.

1. Run the **BisonCap** program from the **Start > Programs/All Programs > BisonCam** menu (it is recommended that you **set the capture file** before the capture process - **see Set Capture File below**).
2. Go to the **Capture** menu heading (if you wish to capture audio check **“PC Camera Audio Setup” on page 7 - 8**) and select **Start Capture**.
3. On the first run of the program (if you have not set the captured file) you will be asked to choose a file name and size (**see the sidebar - Pre-Allocating File Space**) for the captured file. Click **Start Capture** again.
4. Click **OK** to start capturing the video, and press **Esc** to stop the capture.
5. If you wish to, you may go to the **File** menu and select **Save Captured Video As...**, choose a file name and location, then click **Open** (you can view the file using the **Windows Media Player**).

Set Capture File

In the **BisonCap** program you will only be asked to set the capture file name on the first run of the program. When you run the program the next time the file will automatically be overwritten with the newly captured file. To avoid overwriting files you can go to the **Set Capture File..** option in the **File** menu, and set the file name and location before capture. Set the name and location then click **Open** (you can choose **Cancel** to ignore the file size if prompted).

Eliminating Screen Flicker

If you find that the video screen in the **BisonCap** program is flickering, you can try to adjust the setting in the **Video Capture Filter** options.

1. Run the **BisonCap** program.
2. Go to **Options** and scroll down to select “**Video Capture Filter...**”.
3. Click either **50Hz** or **60Hz** under **Frequency** in **Property Page** (tab).

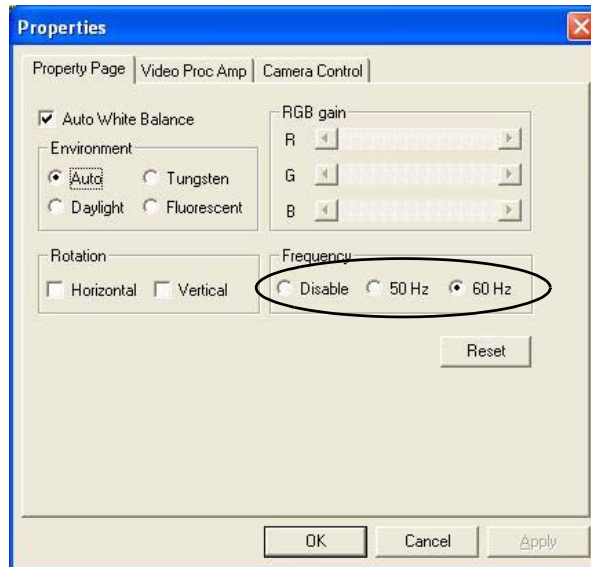

Figure 7 - 5
Video Capture Filter



Port Replicator AC/DC Adapter

You will be provided with a **90W AC/DC adapter** if you purchase the port replicator option.

If you are using the computer with the Port Replicator, then you **must use the 90W AC/DC adapter** to power the port replicator and computer (**DO NOT USE the computer's 65W AC/DC adapter to power the Port Replicator**).

Port Replicator

If you have included the Port Replicator in your purchase option, the device will allow you to easily attach the notebook to standard, non-portable devices e.g. a printer or monitor. **Note the sidebar warning on the power supply.**

You will be provided with a CD including drivers for the serial (COM) port, and for the network (LAN) jack. See **“Port Replicator Setup Instructions:” on page 7 - 13** for configuration information.

1. 4 * USB Ports
2. RJ-45 LAN Jack
3. Parallel (printer) Port
4. Serial Port
5. External Monitor Port
6. Port Replicator DC-In
7. Port Replicator Power Cable (to computer's DC-In)
8. External Monitor Cable (to computer's External Monitor Port)

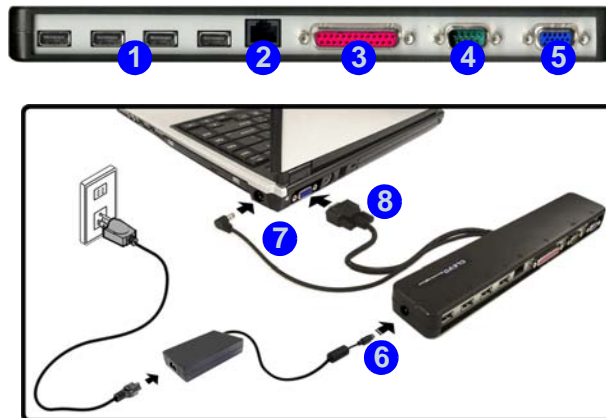

Figure 7 - 6
Port Replicator

Port Replicator Setup Instructions:

1. Turn the computer OFF.
2. Attach the Port Replicator's external monitor cable to the external monitor port on the rear of the computer.
3. Attach the Port Replicator's power cable to the DC-In jack on the right of the computer.
4. **Attach the Port Replicator's (90W) AC/DC adapter** unit to the DC-In jack on the left side of the Port Replicator (**DO NOT USE THE COMPUTER'S POWER SUPPLY UNIT TO POWER THE PORT REPLICATOR** - see "*Port Replicator AC/DC Adapter*" on page 7 - 12).
5. Turn ON the computer.
6. Install the serial port driver (see page 7 - 14).
7. Install the LAN driver (see page 7 - 14).
8. Plug in any devices you require into the appropriate Port Replicator port/jack (note certain devices may require their own drivers, and/or the computer to restart).

For a more detailed description of any of the interface ports and jacks see "*Interface (Ports & Jacks)*" on page A - 1.

Port Replicator Serial (COM) Port Driver (WinXP)

1. Insert the provided Port Replicator CD into the computer's CD/DVD drive.
2. Click **Start** (menu) > **Run...** and navigate (**Browse...**) to **D:\PL-2303 Driver Installer\PL-2303 Driver Installer.exe** and click **OK**.
3. Click **Next** > **Finish**.

Port Replicator Network (LAN) Driver (WinXP)

1. Attach the Port Replicator as per the instructions in *“Port Replicator” on page 7 - 12*.
2. Insert the provided Port Replicator CD into the computer's CD/DVD drive.
3. If you can see the **My Computer** icon on the desktop (if you cannot see the **My Computer** icon go to **step 4**) click on it once to select it, then right-click it to make the sub-menu appear and scroll down to **Properties** and click on it (go to **step 5**).
4. If you cannot see the **My Computer** icon **Start** (menu), then point to (but don't click it, just highlight it) **My Computer**. Right-click it to make the sub-menu appear and scroll down to **Properties** and click on it (go to **step 5**).
5. Click **Hardware** (tab), then click **Device Manager** (button).

6. Click "+" next to **Other devices** (if its sub-menu items are not shown).
7. Double-click **AX88772** and click **Driver** (tab).
8. Click **Update Driver** (button).
9. Select "**No, not this time**" then click **Next**.
10. When the *Hardware Update Wizard* appears, click "**Install from a list or specific location (Advanced)**" then click **Next**.
11. Select "**Search for the best driver in these driver in these locations.**" and select ONLY "**include this location in the search:**".
12. Navigate (**Browse...**) to **D:\LAN** and click **OK** > **Next**.
13. Click **Finish** and close the open windows.

Chapter 8: Troubleshooting

Overview

Should you have any problems with your computer, before consulting your service representative, you may want to try to solve the problem yourself. This chapter lists some common problems and their possible solutions. This can't anticipate every problem, but you should check here before you panic. If you don't find the answer in these pages, make sure you have followed the instructions carefully and observed the safety precautions in the preface. If all else fails, talk to your service representative. You should also make a record of what happened and what remedies you tried.

Of course, if something goes wrong, it will happen at the most inconvenient time possible, so you should preview this section just in case. If, after you've tried everything, and the system still won't cooperate, try turning it off for a few minutes and then rebooting. You will lose any unsaved data, but it may start working again. Then call your service representative.

Basic Hints and Tips

Many of the following may seem obvious but they are often the solution to a problem when your computer appears not to be working.

- **Power** - Is the computer actually plugged into a working electrical outlet? If plugged into a **power strip**, make sure it is actually working. Check the **LED Power & Communication Indicators** (see *“LED Indicators” on page 1 - 9*) to see the computer’s power status.
- **Connections** - Check all the **cables** to make sure that there are no **loose connections** anywhere.
- **Power Savings** - Make sure that the system is not in **Hibernate** or **Standby** mode by pressing the keys configured in your *Power Management/Power Options* (see *“Configuring the Power Button” on page 3 - 8*), the **Fn + F4** key combination, or power button to wake-up the system.
- **Brightness** - Check the brightness of the screen by pressing the **Fn + F8 and F9** keys to adjust the brightness.
- **Display Choice** - Press **Fn + F7** to make sure the system is not set to “external only” display.
- **Boot Drive** - Make sure there are no **floppy disks** in any connected drive when you start up your machine (this is a common cause of the message *“Invalid system disk - Replace the disk, and then press any key” / “Remove disks or other media. Press any key to restart”*).

Backup and General Maintenance

- Always **backup** your important data, and keep copies of your OS and programs safe, but close to hand. Don't forget to note the **serial numbers** if you are storing them out of their original cases, e.g. in a CD wallet.
- Run **maintenance programs** on your hard disk and OS as often as you can. You may schedule these programs to run at times when you are not using your computer. You can use those that are provided free with your OS, or buy the more powerful dedicated programs to do so.
- Write down your passwords and keep them safe (away from your computer). This is especially important if you choose to use a **Supervisor** password for the BIOS (see *“Security Menu” on page 5 - 10*).
- Keep copies of vital **settings files** such as network, dialup settings, mail settings etc.(even if just brief notes).



Warranty

The CPU is not a user serviceable part. Opening this compartment, or accessing the CPU in any way, may violate your warranty.

Viruses

- Install an **Anti-Virus** program and keep the **definitions file** (the file which tells your program which viruses to look for) up to date. New computer viruses are discovered daily, and some of them may seriously harm your computer and cause you to lose data. **Anti-Virus** programs are commercially available and the **definitions file updates** are usually downloadable directly from the internet.
- Be careful when opening e-mail from sources you don't know. **Viruses** are often triggered from within **e-mail attachments** so take care when opening any attached file. You can configure most **Anti-Virus** programs to check all **e-mail attachments**. **Note:** You should also beware of files from people you know as the virus may have infected an **address book** and been automatically forwarded without the person's knowledge.
- Keep a "**Boot Floppy Disk**" or "**Bootable CD-ROM**" (this disk provides basic information which allows you to startup your computer) handy. You may refer to your OS's documentation for instructions on how to make one, and many **Anti-Virus** programs will also provide such a disk (or at least instructions on how to make one).

Upgrading and Adding New Hardware/Software

- Do not be tempted to make changes to your **Windows Registry** unless you are very sure of what you are doing, otherwise you will risk severely damaging your system.
- Don't open your computer or undertake any repair or upgrade work if you are not comfortable with what you are doing.
- Read the **documentation**. We can assume, since you are reading this that you are looking at the computer's manual, but what about any new peripheral devices you have just purchased? Many problems are caused by the installation of new hardware and/or software. Always refer to the documentation of any new hardware and/or software, and pay particular attention to files entitled "**READ ME**" or "**READ ME FIRST**".
- When installing a new device always make sure the device is powered on, and in many cases you will need to restart the computer. Always check that all the cables are correctly connected.
- Make sure you have installed the **drivers** for any new hardware you have installed (latest **driver files** are usually available to download from vendor's websites).

Troubleshooting

- Thoroughly check any **recent changes** you made to your system as these changes may affect one or more system components, or software programs. If possible, go back and undo the change you just made and see if the problem still occurs.
- Don't over complicate things. The less you have to deal with then the easier the source of the problem may be found; **Example** - if your computer has many devices plugged into its ports, and a number of programs running, then it will be difficult to determine the cause of a problem. Try disconnecting all of the devices and restarting the computer with all the peripheral devices unplugged. A process of elimination (adding and removing devices and restarting where necessary) will often find the source of a problem, although this may be time consuming.

Power

Problem	Possible Cause - Solution
<p>You turned on the power but it doesn't work.</p>	<p><i>Battery missing / incorrectly installed.</i> Check the battery bay, make sure the battery is present and seated properly (the design of the battery only allows it to go in one way). Make sure there's nothing interfering with the battery contacts.</p>
<p>The battery LED power indicator , is blinking orange.</p>	<p><i>Low Battery.</i> Plug in the DC power source. If the computer doesn't start up immediately, turn it off then on again.</p>
<p>You are losing battery power too quickly.</p>	<p><i>The system is using too much power.</i> If your OS has a <i>Power Options</i> scheme (see <i>"Power Schemes"</i> on page 3 - 4) check its settings. You may also be using a PC Card device that is drawing a lot of power.</p>
<p>Actual battery operating time is shorter than expected.</p>	<p><i>The battery has not been fully discharged before being recharged.</i> Make sure the battery is fully discharged and recharge it completely before reusing (see <i>"Battery Information"</i> on page 3 - 9).</p> <p><i>Power Options have been disabled.</i> Go to the Control Panel in <i>Windows</i> and re-enable the options.</p> <p><i>A peripheral device or PC Card is consuming a lot of power.</i> Turn off the unused device to save power.</p>

Troubleshooting

Problem	Possible Cause - Solution
The computer feels too hot.	<p>Make sure the computer is properly ventilated and the Vent/Fan intakes are not blocked. If this doesn't cool it down, put the system into Hibernate mode or turn it off for an hour. Make sure the computer isn't sitting on a thermal surface (see "Overheating" on page 1 - 15). Make sure you're using the correct adapter.</p> <p>Make sure that your notebook is completely powered off before putting it into a travel bag (or any such container). Putting a notebook which is powered on in a travel bag may cause the Vent/Fan intakes to be blocked.</p>

8



Port Replicator AC/DC Adapter

You will be provided with a **90W AC/DC adapter** if you purchase the port replicator option.

If you are using the computer with the Port Replicator, then you **must use the 90W AC/DC adapter** to power the port replicator and computer (**DO NOT USE the computer's 65W AC/DC adapter to power the Port Replicator**).

Display

Problem	Possible Cause - Solution
<p>Nothing appears on screen.</p>	<p><i>The system is in a power saving mode.</i> Toggle the sleep/resume key combination, Fn + F4 (see “Sleep Button” on page 3 - 8).</p> <p><i>The screen controls need to be adjusted.</i> Toggle the screen control key combinations Fn + F8/F9. If you're connected to an external monitor, make sure it's plugged in and turned on. You should also check the monitor's own brightness and contrast controls.</p> <p><i>The computer is set for a different display.</i> Toggle the screen display key combination, Fn + F7. If an external monitor is connected, turn it on.</p> <p><i>The screen saver is activated.</i> Press any key or touch the TouchPad.</p>
<p>No image appears on the external monitor I have plugged in and powered on.</p>	<p><i>You haven't installed the video driver and configured it appropriately from the Control Panel.</i> See “Intel Video Driver Controls” on page B - 1 for instructions on installing and configuring the video driver.</p>

Boot Password

Problem	Possible Cause - Solution
You forget the boot password.	<i>If you forget the password, you may have to discharge the battery of the CMOS. Contact your service representative for help.</i>



Password Warning

If you choose to set a boot password, **NEVER** forget your password. The consequences of this could be serious. If you cannot remember your boot password you must contact your vendor and you may lose all of the information on your hard disk.

Audio & CD Device

Problem	Possible Cause - Solution
The sound cannot be heard or the volume is very low.	<i>The volume might be set too low.</i> Check the volume control in the Volume Control Panel in the <i>Windows</i> taskbar, or use the key combination Fn + F5 and F6 (see “Audio Features” on page 2 - 12) to adjust.
The compact disc cannot be read.	<i>The compact disc is dirty.</i> Clean it with a CD-ROM cleaner kit.
The compact disc tray will not open when there is a disc in the tray.	<i>The compact disc is not correctly placed in the tray.</i> Gently try to remove the disc using the eject hole (see “Loading Discs” on page 2 - 3).
The DVD regional codes can no longer be changed.	<i>The code has been changed the maximum 5 times.</i> See “DVD Regional Codes” on page 2 - 5 .

Keyboard

Problem	Possible Cause - Solution
Unwelcome numbers appear when typing.	<i>If the LED  is lit, then Num Lock is turned ON. (see “LED Indicators” on page 1 - 9).</i>



Other Keyboards

If your keyboard is damaged or you just want to make a change, you can use any standard USB keyboard. The system will detect and enable it automatically. However special functions/hot keys unique to the system's regular keyboard may not work.

Operation

Problem	Possible Cause - Solution
The system freezes or the screen goes dark.	<i>The system's power saving features have timed-out.</i> Use the AC/DC adapter, press the sleep (Fn + F4) key combination, or press the power button if no LEDs are lit.
The system never goes into a power saving mode.	Power Options features are not enabled. Go to the Windows Power Options menu and enable the features you prefer (see " System Power Options " on page 3 - 6). Make sure you have enabled Hibernate mode from the control panel.

Modules







Problem	Possible Cause - Solution
<p>The Wireless LAN/Bluetooth modules cannot be detected.</p>	<p><i>The modules are off.</i> Check the LED indicator (🔦) to see if the WLAN/Bluetooth module is on or off (see “LED Indicators” on page 1 - 9). If the LED indicator is off, then press the Fn + F11 (WLAN) or Fn + F12 (Bluetooth) key combination(s) in order to enable the modules (see “Function Keys” on page 1 - 11).</p>
<p>The PC Camera modules cannot be detected.</p>	<p><i>The module is off.</i> Press the Fn + F10 key combination in order to enable the module (see “Function Keys” on page 1 - 11). Run the BisonCap program (see “PC Camera” on page 7 - 6) to view the camera picture.</p>
<p>The Wireless LAN/Bluetooth/ PC Camera modules cannot be configured.</p>	<p>The driver(s) for the module(s) have not been installed. Make sure you have installed the driver for the appropriate module (see the instructions for the appropriate module in “Modules & Options” on page 7 - 1).</p>







Appendix A: Interface (Ports & Jacks)

Overview



The following chapter will give a quick description of the interface (ports & jacks) which allow your computer to communicate with external devices, connect to the internet etc.

Notebook Ports and Jacks

Item	Description
Built-In Microphone 	The built-in microphone allows you to record on your computer
Card Reader Port 	The card reader allows you to use some of the latest digital storage cards. Push the card into the slot and it will appear as a removable device.
DC-In Jack 	Plug the supplied AC/DC adapter into this jack to power your computer.
External Monitor (VGA) Port 	This port allows you to connect an external monitor, or Flat Panel Display, to get dual video or simultaneous display on the LCD and external monitor/FPD (see “Display Devices” on page B - 6).
Headphone-Out Jack 	Headphones or speakers may be connected through this jack. Note: Set your system's volume to a reduced level before connecting to this jack.
Line-In Jack 	The Line-In jack allows you to play audio sources through the computer's speakers.





Item	Description
Microphone-In Jack 	Plug an external microphone in to this jack to record on your computer.
Mini-IEEE 1394 Port 	This port allows a high-speed connection to various peripheral devices, e.g. external disk drives and digital cameras (see note below). <div style="border: 2px solid red; border-radius: 15px; padding: 10px; text-align: center;">  Mini-IEEE 1394 Port The Mini-IEEE 1394 port only supports SELF POWERED IEEE 1394 devices. </div>
RJ-11 Phone Jack 	This port connects to the built-in modem. You may plug the telephone line directly into this RJ-11 telephone connection. Note: Broadband (e.g. ADSL) modems usually connect to the LAN port.
RJ-45 LAN Jack 	This port supports LAN (Network) functions. Note: Broadband (e.g. ADSL) modems usually connect to the LAN port.
Security Lock Slot 	To prevent possible theft, a Kensington-type lock can be attached to this slot. Locks can be purchased at any computer store.

Interface (Ports & Jacks)

Item	Description
S/PDIF-Out Jack SPDIF	This S/PDIF (Sony/Philips Digital Interface Format) Out Jack allows you to connect your DVD-capable PC to a Dolby AC-3 compatible receiver for "5.1" or 'dts' surround sound.
S-Video-Out Port 	Connect your television to your computer and view DVDs, VCDs or anything else your computer can display. You will need an S-Video cable to make the connection. Enable this port from the video driver controls.
USB 2.0/1.1 Ports 	These USB 2.0 compatible ports (USB 2.0 is fully USB 1.1 compliant) are for low-speed peripherals such as keyboards, mice or scanners, and for high-speed peripherals such as external HDDs, digital video cameras or high-speed scanners etc. Devices can be plugged into the computer, and unplugged from the computer, without the need to turn the system off (if the power rating of your USB device is 500mA or above, make sure you use the power supply which comes with the device).

A

Optional Port Replicator Ports and Jacks

Item	Description
DC-In Jack 	Plug the supplied AC/DC adapter into this jack to power your computer.
External Monitor (VGA) Port 	This port allows you to connect an external monitor, or Flat Panel Display, to get dual video or simultaneous display on the LCD and external monitor/FPD (see “Display Devices” on page B - 6).
Parallel Port 	Connect a parallel type printer to this port. The port supports ECP (Extended Capabilities Port) and EPP (Enhanced Parallel Port) 1.7/1.9 modes.
Serial Port 	Connect a serial type mouse to this port.
RJ-45 LAN Jack 	This port supports LAN (Network) functions. Note: Broadband (e.g. ADSL) modems usually connect to the LAN port.

Interface (Ports & Jacks)

Item	Description
<p data-bbox="204 227 400 249">USB 2.0/1.1 Ports</p> 	<p data-bbox="469 227 1428 398">These USB 2.0 compatible ports (USB 2.0 is fully USB 1.1 compliant) are for low-speed peripherals such as keyboards, mice or scanners, and for high-speed peripherals such as external HDDs, digital video cameras or high-speed scanners etc. Devices can be plugged into the computer, and unplugged from the computer, without the need to turn the system off (if the power rating of your USB device is 500mA or above, make sure you use the power supply which comes with the device).</p>

Appendix B: Intel Video Driver Controls

The basic settings for configuring the LCD are outlined in *“Video Features”* on page 1 - 17.

Intel Video Driver Installation

Make sure you install all the drivers in the order indicated in *Table 4 - 1, on page 4 - 6*. Instructions for installing the video driver are repeated below.

1. Click **2.Install Video Driver > Yes** from the Drivers Installer menu.
OR
Navigate (**Browse..**) to
D:\Drivers\Video\Setup.exe and click **OK**.
2. Click **Next > Yes**.
3. Click **Finish** to restart the computer.

DVMT Notes

DVMT is not user-configurable.

DVMT is not local video memory.

DVMT will not function in MS-DOS. DOS uses the legacy memory indicated.

Figure B - 1
DVMT Memory Requirements

Dynamic Video Memory Technology

Intel® DVMT 3.0 automatically and dynamically allocates as much (up to **128MB**) system memory (RAM) as needed to the video system (**the video driver must be installed - see page B - 1**). DVMT returns whatever memory is no longer needed to the operating system.

Information Tab

The **information** tab in **Graphics Properties** in the **intel(R) Graphics Media Accelerator Driver** (tab) lists details of your computer's memory etc. See *"Intel Graphics Properties"* on page B - 3 to see how to access this Information tab.

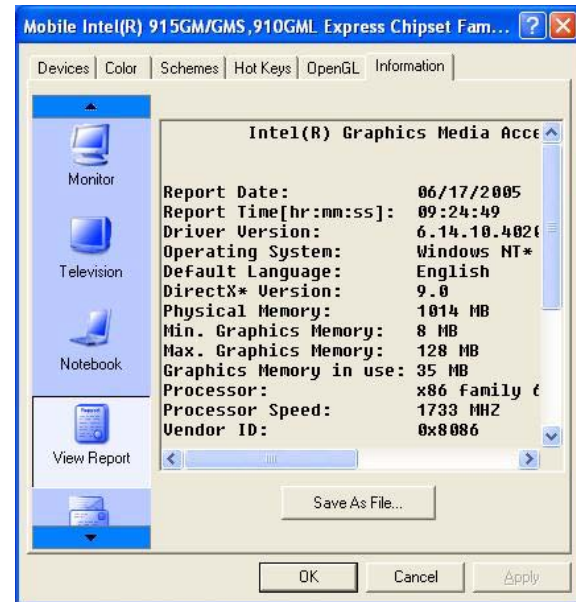

Intel Graphics Properties

More advanced video configuration options are provided by the **Intel(R) Graphics Media Accelerator Driver**.

1. Open **Display Properties** (see *“Video Features” on page 1 - 17*).
2. Click the **Intel(R)...** tab and click **Graphics Properties** (button).
3. You can also access **Graphics Properties** from the **Windows Intel(R) GMA Driver for Mobile** control panel.

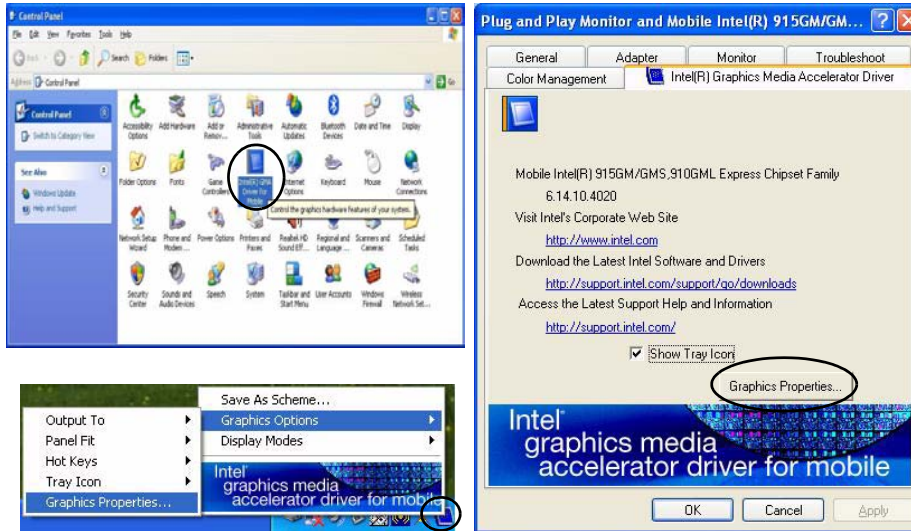

Taskbar Icon

You can also access the controller properties from the taskbar. Click on the icon to bring up the menu and scroll to **Graphics Options > Graphics Properties**.

If you cannot see the tray icon go to the **Intel(R) Graphics Media Accelerator Driver** tab (in the **Display Properties > Advanced** options) and click the **“Show Tray Icon”** tickbox.

B

Figure B - 2
Intel Graphics Properties

Intel Video Driver Controls

Intel Graphics Properties

Note that the **Graphics Properties** control panel is entitled **Mobile Intel(R) 915GM/GMS, 910GML Express Chipset Family**.

Figure B - 3
Intel Graphics Properties (Control Panel Tabs)

You may make changes to the Devices, Color, Schemes, Hot Keys by clicking the appropriate tab and adjusting the setting, then clicking OK. The Information and Open GL tabs display useful information about the graphics properties of the computer, and the Support item in the Information tab has weblinks to the latest information on the Intel Website.

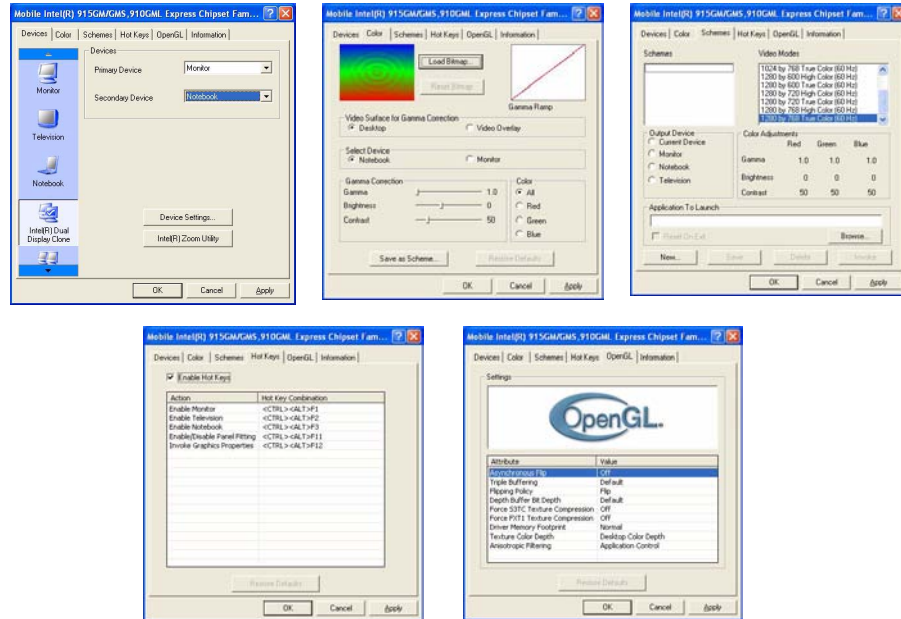

Schemes

Use Schemes to configure quick settings for applications which require specific resolution and color settings in order to run properly e.g. games, multimedia programs. To set the schemes:

1. Go to the **Graphics Properties** control panel (see *"Intel Graphics Properties" on page B - 3*).
2. Configure your display configuration, resolution etc. as per your requirements, from **Devices** (tab).
3. Click on **Schemes** (tab).
4. Click **New** (button), and type a name for the scheme then click **OK**.
5. If you want to automatically launch an application when running the scheme click on **Browse** (button).
6. **Browse** to the executable file for the application you want to set a scheme for (see sidebar), and click **Open** to select it.
7. Click **Save** to save the settings (you can click in the **"Reset On Exit"** box to return to your original settings when you exit the program).
8. Click **OK** to exit the program.



Application.exe

You will need to locate the actual **application executable (.exe) file**, not just the shortcut. To find the application right-click its **shortcut** on the desktop click **Properties**. Click the **Shortcut** (tab) and see where the executable file is located by clicking the **Find Target** (button). Note the location and you will then be able to browse to this file.



Function Key Combination

You can use the **Fn + F7** key combination to toggle through the display options:

- Notebook Only
- External Display Only
- Notebook + External Display

Make sure you give the displays enough time to refresh.

Display Devices

Besides the built-in LCD, you can also use an external monitor/flat panel display or TV as your display device. The following are the display options:

1. The built-in LCD.
2. An external monitor connected to the external monitor port.
3. A flat panel display connected to the external monitor port.
4. A TV connected to the S-Video-Out Port.



Television Display Warning

After you have connected a TV as a Display device for the first time, the Television icon will appear in the Devices tab permanently thereafter (whether or not as television is connected to the S-Video-Out Port).

If you select the Television as the single display device when no TV is connected to the S-Video-Out Port, the screen may appear blank. If this happens use the Fn + F7 key combination to toggle through the display options until the display reappears on the notebook screen.

Attaching Other Displays

If you prefer to use a monitor or flat panel display, connect it to the external monitor port on the left of the computer.

1. Attach your external monitor to the external monitor port, and turn it on.
2. Go to the **Graphics Properties** control panel (see *“Intel Graphics Properties” on page B - 3*) and click **Devices** (tab).
3. Choose the display option from the list on the left.
4. Choose which attached device will be **Primary** or **Secondary**.
5. Click **Apply** (and **OK** to confirm the settings change) and **OK** (button).

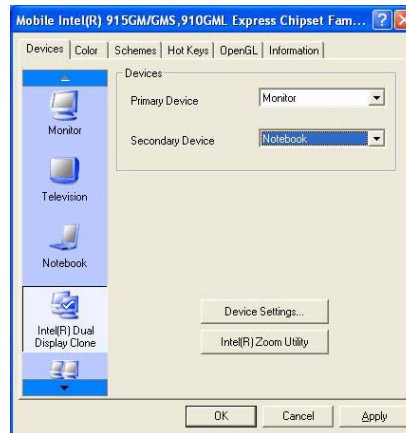

Intel Display Note

Note that the monitor is the default Primary display device in both Intel(R) Dual Display Clone Mode and Extended Desktop Mode.

Figure B - 4
Devices



Function Key Combination

You can use the **Fn + F7** key combination to toggle through the display options:

- Notebook Only
- External Display Only
- Notebook + External Display

Make sure you give the displays enough time to refresh.

Note the *“Television Display Warning”* on page B - 6.

Display Modes

Single Display

Only one of your attached displays is used.

Intel(R) Dual Display Clone

This mode will drive multiple displays with the same content. Each device may be configured independently for different resolutions, refresh rates, color quality etc. Use this feature to display the screen through a projector for a presentation.

Extended Desktop

This mode allows a desktop to span multiple displays and acts as a large workspace. This creates a lot more screen area for display. Use the **Display Properties** control panel to drag the monitors to match the physical arrangement you wish to use, or you may also use the **Extended Desktop Settings** control panel tab in **Graphics Properties** to configure the relative size and position.

To Enable Intel(R) Dual Display Clone Mode

1. Attach your external monitor to the external monitor port (or TV to the S-Video-Out Port), and turn it on.
2. Go to the **Graphics Properties** control panel (see *"Intel Graphics Properties" on page B - 3*) and click **Devices** (tab).
3. Click **Intel(R) Dual Display Clone** (icon).
4. Choose which attached device will be **Primary** or **Secondary**.
5. Adjust the settings by clicking the **Display Settings** (tab) if necessary.
6. Click **Apply** (and **OK** to confirm the settings change) and **OK** (button).

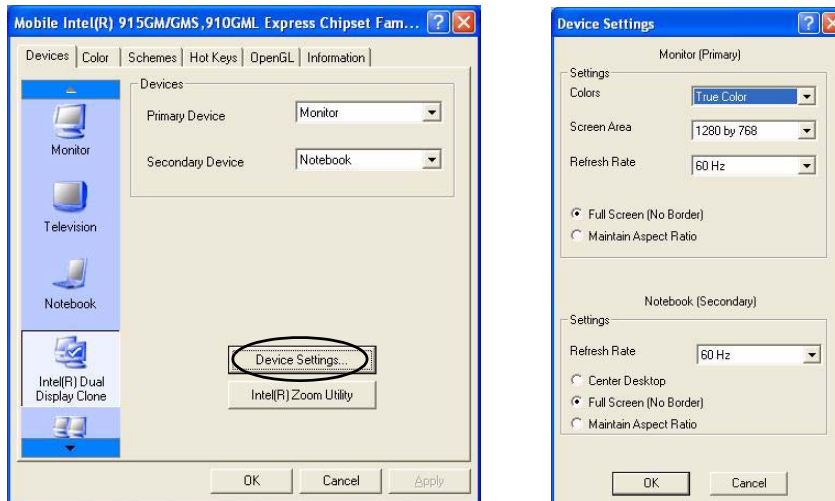

Figure B - 5
Display Settings
(Clone)

Display Settings Extended Desktop

You can have different Colors, Screen Area and Monitor Refresh Rates for each display device **provided your monitor can support them.**

You can drag the monitor icons to match the physical layout of your displays. Icons and programs may also be dragged between the displays.

Figure B - 6
**Extended Desktop
Mode**

To Enable Extended Desktop Mode:

1. Attach your external monitor to the external monitor port (or TV to the S-Video-Out Port), and turn it on.
2. Go to the **Graphics Properties** control panel (see *“Intel Graphics Properties” on page B - 3*) and click **Devices** (tab).
3. Click **Extended Desktop** (icon).
4. Choose which attached device will be **Primary** or **Secondary**.
5. Adjust the settings by clicking the **Device Settings** (button) if necessary.
6. Click **Apply** (and **OK** to confirm the settings change) and **OK** (button).

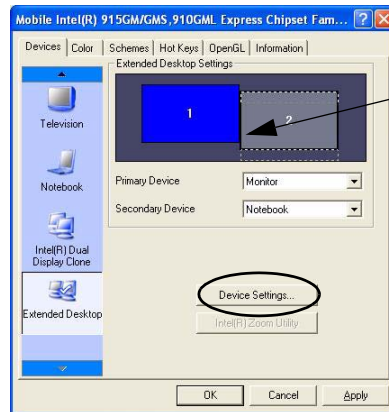

Click the appropriate monitor icon and drag it to match the physical arrangement you wish to use (e.g. the secondary display may be extended left/right/above/below the primary display).

Click Display Settings to make any adjustments required.

You can also enable the Extended Desktop mode from the **Display Properties** control panel (see page *B - 11*).

To Enable Extended Desktop (Display Properties)

1. Attach your external monitor to the external monitor port (or TV to the S-Video-Out Port), and turn it on.
2. Click **Start**, point to **Settings** (or click **Control Panel**) and click **Control Panel** (if you are in **Category View** choose **Appearance and Themes**).
3. Double-click **Display** (icon).
4. In the **Display Properties** dialog box, click **Settings** (tab).
5. Click the monitor icon (e.g. **2**), and make sure you have checked “**Extend my Windows desktop onto this monitor.**” and click **Apply**.

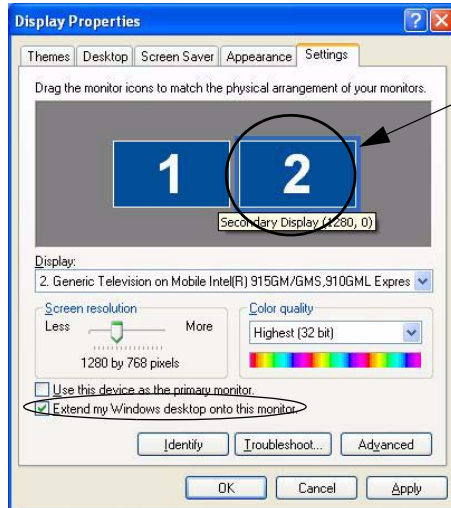

Click the appropriate monitor icon (e.g. **2**) to be able to select the option to extend the desktop on to it.

In this example the Primary monitor **1** is on the left, the secondary display **2** is on the right.



Display Settings Extended Desktop

Use the control panel to drag the monitors to match the physical arrangement you wish to use.

You can drag any icons or windows across to either display desktop, which makes it possible to have one program visible in one of the displays, and a different program visible in the other display.

B

Figure B - 7
**Display Properties
(Extended Desktop)**

Function Key Combination

You can use the **Fn + F7** key combination to toggle through the display options:

- Notebook Only
- External Display Only
- Notebook + External Display

Make sure you give the displays enough time to refresh.

Note the *“Television Display Warning”* on page B - 6.

TV Settings

If you are using a TV as a display device you may adjust the settings as follows:

1. Attach your TV to the S-Video-Out Port and turn it on.
2. Go to the **Graphics Properties** control panel (see *“Intel Graphics Properties”* on page B - 3) and click **Devices** (tab).
3. Choose the television as one of your display devices.
4. Adjust the settings by clicking the **Display Settings** (button).
5. Choose the appropriate TV system from **Video Standard** dropdown.
6. Click the **TV Settings** (button) if the TV is set to be the **only** display device (click the **Television** icon and click **Apply** to set the TV as the only display device).

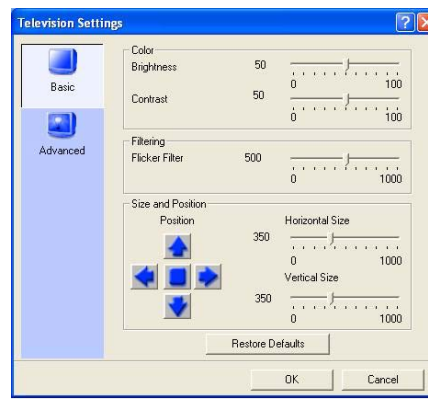
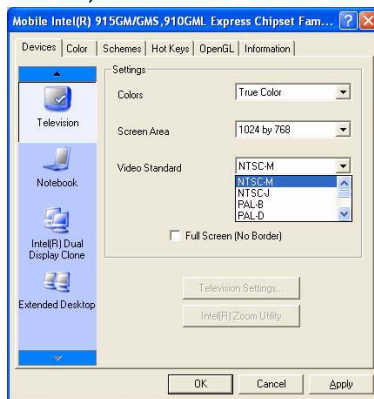

Figure B - 8
TV Display Settings

Appendix C: Specifications



Latest Specification Information

The specifications listed in this Appendix are correct at the time of going to press. Certain items (particularly processor types/speeds and CD/DVD device types) may be changed or updated due to the manufacturer's release schedule. Check with your service center for details.

Specifications

Feature	Specification	
Processor	Intel Pentium® M Processor (478-pin) Micro-FC-PGA Package Models 730/ 740/ 750/ 760/ 770/ 780	(μ0.09) 0.09 Micron Process Technology 2MB On-die L2 Cache & 533MHz FSB 1.6/ 1.73/ 1.86/ 2/ 2.13/ 2.26 GHz
	Intel Celeron® M Processor (478-pin) Micro-FCPGA Package Models 350/ 360/ 370/ 380/ 390	(μ0.09) 0.09 Micron Process Technology 1MB On-die L2 Cache & 400MHz FSB 1.3/ 1.4/ 1.5/ 1.6/ 1.7 GHz
Core Logic	Intel 915GM + ICH6-M	
Memory	Two 200 Pin SO-DIMM Sockets Supporting DDRII (DDR2) 400 / 533 MHz 128-bit Wide DDRII (DDR2) Data Channel Memory Expandable up to 2GB (256/ 512/ 1024 MB DDRII Modules) (Note: Do Not Use Other Module Types)	
Security	Security (Kensington® Type) Lock Slot	
BIOS	One 4MB Flash ROM	Phoenix™ BIOS, Plug and Play
LCD	<u>Model A Computers:</u> 15.0" XGA (1024*768) Flat Panel TFT OR 15.0" SXGA+ (1400*1050) Flat Panel TFT	<u>Model B Computers:</u> 14.0" WXGA (1280*768) Flat Panel TFT

Feature	Specification
Video Adapter	Intel 915GM Integration Intel® Graphics Media Accelerator 900 (Intel® GMA 900) Dynamic Video Memory Technology DVMT 3.0 - Supports up to 128MB of Video Memory (dynamically allocated from system memory where needed) Supports Analog Monitor Pixel Resolution up to 1600 * 1200 at 85Hz Integrated High Quality 3D Graphics Engine Accelerator
Storage	One Changeable 12.7mm(h) Optical Device (CD/DVD) Type Drive (see “Optional” on page C - 5 for drive options) Easy Changeable 2.5" 9.5 mm (h) IDE HDD with PATA (Parallel) Interface Supports ATA 100/ 66/ 33
Audio	Integrated AZALIA Compliant Interface (HAD) 3D Stereo Enhanced Sound System Sound-Blaster PRO™ Compatible 2 * Built-In Speakers Built-In Microphone
Keyboard & Pointing Device	Winkey Keyboard Built-In TouchPad with Scrolling Function
PCMCIA	One Type-II PCMCIA CardBus PC Card Slot

Specifications

Feature	Specification	
Interface	Four USB 2.0 Ports One External Monitor Port One Headphone-Out Jack One Microphone-In Jack One Line-In Jack One S/PDIF Output Jack	One RJ-11 Jack for Plug & Play Fax/Modem One RJ-45 Jack for 10Mb/ 100Mb/ 1000Mb Fast Ethernet One Mini-IEEE 1394 Port One S-Video-Out Port (supports HDTV) One DC-in Jack Note: External 7.1 CH Audio Output Support Configurable through Headphone, Microphone, Line-In and S/PDIF Jacks
Card Reader	Embedded 4-in-1 Card Reader (MS/ MS PRO/ SD/ MMC)	
Communication	AZALIA 56K Plug & Play Fax/Modem v.90/92 Compliant 10Mb/ 100Mb/ 1000Mb Fast Ethernet Intel® PRO/Wireless 2915ABG Mini PCI Wireless LAN Module (Factory Option) Bluetooth Module - Version 1.2 (Factory Option) 300K PC Camera with USB Interface (Factory Option) 1.3M PC Camera with USB Interface	
Power Management	Supports ACPI 2.0 Power Button as Sleep/Resume Key Supports Hibernate Mode Supports Standby	Supports Battery Low Suspend Supports Resume from Modem Ring Supports Wake on LAN

Specifications

Feature	Specification	
Power	Full Range AC/DC Adapter 20V, 3.25A (65 Watts), 100~240V, 47~63Hz Full Range AC/DC Adapter 20V, 5.25A (90 Watts), 100~240V, 50~60Hz (If using the optional Port Replicator) 6 Cell Smart Lithium-Ion Battery Pack, 4000mAH (44.4W) 6 Cell Smart Lithium-Ion Battery Pack, 4400mAH (48.8W)	
Environmental Spec	Temperature Operating: 5°C ~ 35°C Non-Operating: -20°C ~ 60°C	Relative Humidity Operating: 20% ~ 80% Non-Operating: 10% ~ 90%
Physical Dimensions & Weight	<u>Model A Computers:</u> 333mm (w) * 276mm (d) * 24-33mm (h) 2.2 kg Without Battery	<u>Model B Computers:</u> 333mm (w) * 243mm (d) * 24-33mm (h) 1.9 kg Without Battery
Optional	Optical Drive Module Options: DVD-ROM Drive Module DVD/CD-RW Combo Drive Module DVD-Dual Drive Module Port Replicator (10/100 Base-T Ethernet Port, 4 * USB 2.0 Ports, Serial Port, Parallel Port, External Monitor Port, DC-In Jack) (Note: Port Replicator requires the supplied 90W power adapter)	Charger Box (Factory Option) PC Camera with USB Interface (Factory Option) Bluetooth Module - Version 1.2 (Factory Option) Swap Battery - 2 ~ 3 Minutes Swap Time (Model A only)



Specifications

C