

Omnino 4 Security Pillar and Padlock kit for Omnino 4

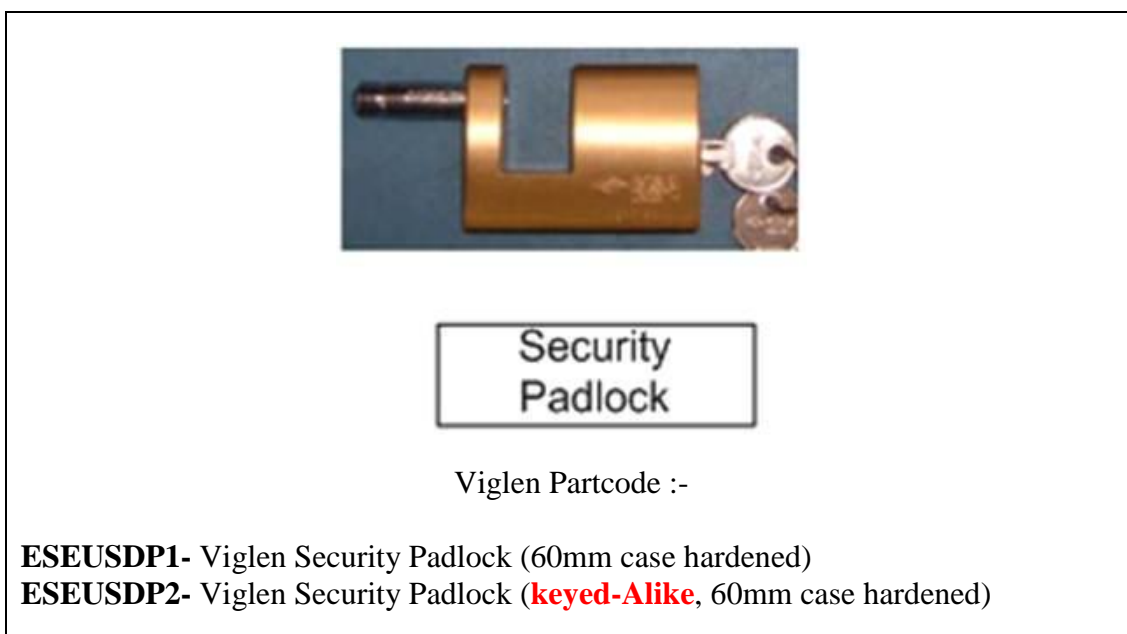

Viglen

Great
Minds
Think

Viglen

Assembly of security Pillar kit:

The customer may require a security bolt fitted to the base of the chassis. Remove the display if already fitted. Lay the chassis on its back, **be careful not to scratch any of the panels**. Remove the base plate and place the security bolt through the large centre hole. Refit the base plate and secure with the 6 retaining screws.

1. Remove the centre rubber bumper from the bottom of the chassis by unscrewing the screw in the centre of it.

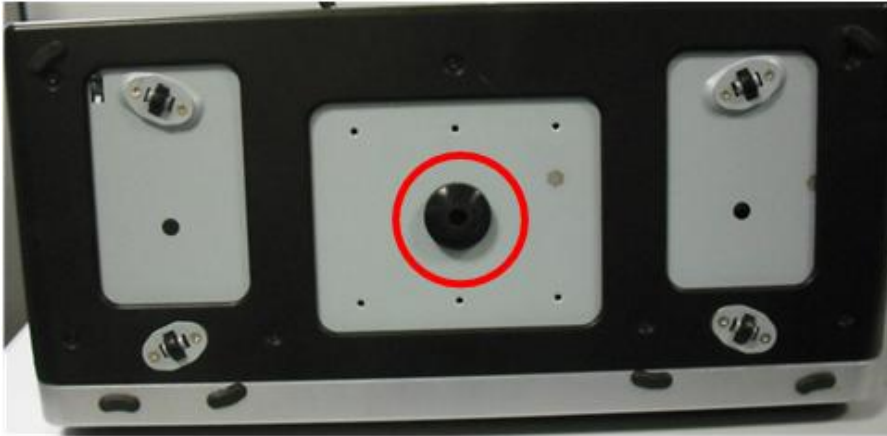
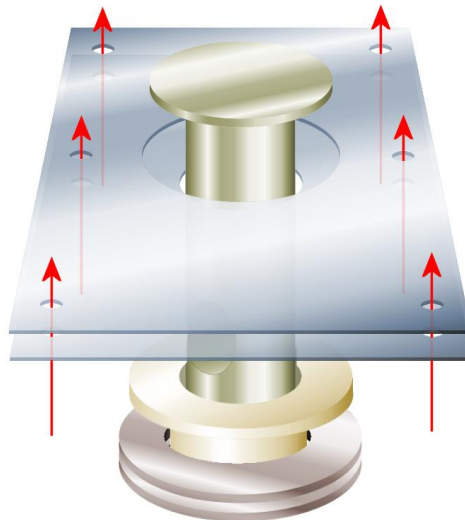

Figure 1: Remove the rubber bumper

2. Once the rubber bumper has been removed Fit the Inner, outer plates and the security bolt as shown in **Figure 2** and **Figure 3**.



Security bolt and plates order assembly

viglen

Great
Minds
Think

viglen

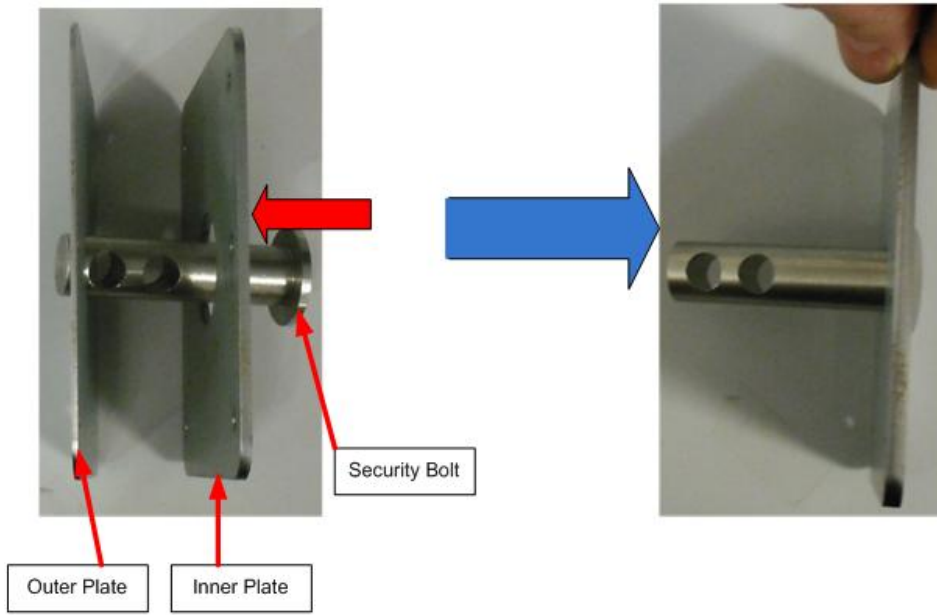

Figure 2: Security bolt and plates order

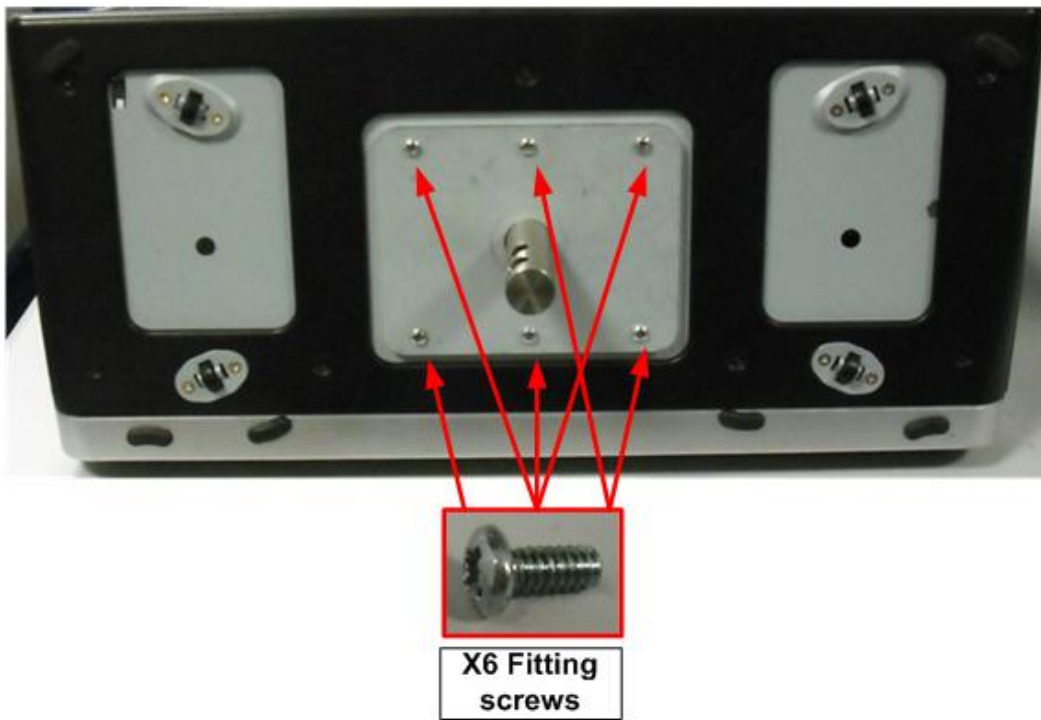

Figure 3: Fitting the plates and security bolt to the chassis

viglen

Great
Minds
Think

viglen

3. Fit the nylon sleeve into the pre-drilled (22.5mm) hole on the desktop



Figure 4: Nylon sleeve fitment

4. Feed the bolt with chassis attached through the hole in the desktop

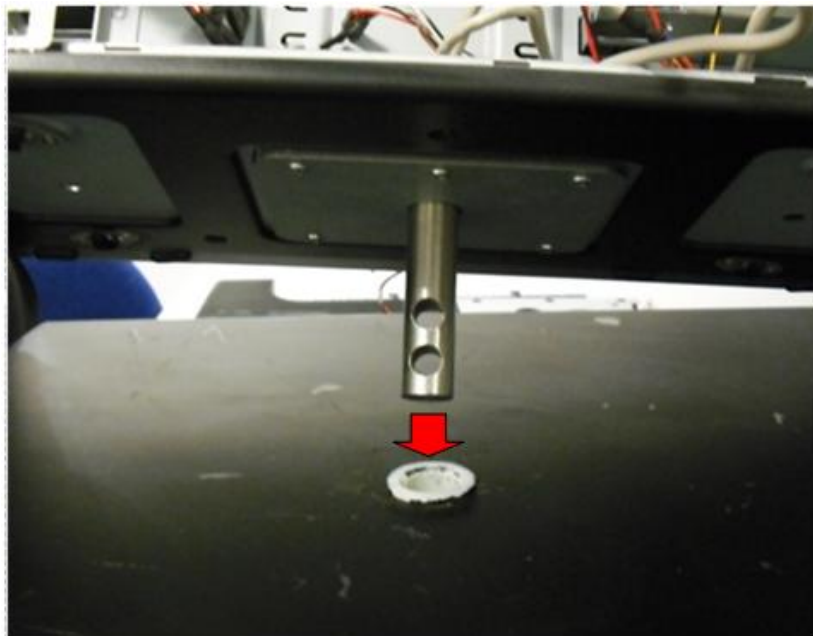

Figure 5: Secure chassis through the desk hole

viglen

Great
Minds
Think

viglen

8. Fit the required amount of nylon spacers over the surety bolt and then fit the security padlock.

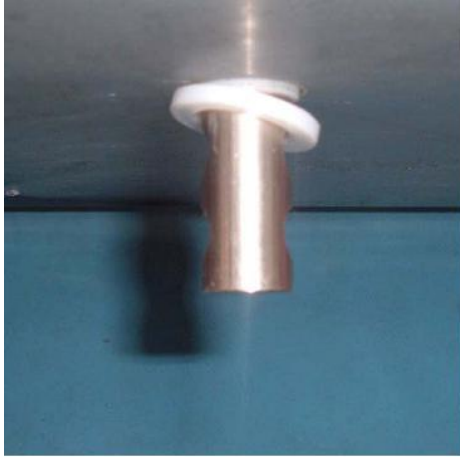

Figure 6: Nylon spacer fitment



Figure 7: Security Padlock fitted.

viglen

Great
Minds
Think

viglen