

# Omnino HS User Guide



**Great  
Minds  
Think**



COMPUTERS ♦ NETWORKS ♦ SOLUTIONS

# Viglen EMC and the 'CE' mark

---

## CE Marking

As we begin the 21st century, European standards are being harmonised across borders. If products comply with the same standards in all European countries, product exporting and importing is made simple - paving our way to a common market. If you buy a product with a 'CE' mark on it (shown below), on the box, in the manual, or on the guarantee - it complies with the currently enforced directive(s).



## Introduction to EMC

EMC (Electromagnetic Compatibility) is the term used to describe certain issues with RF (Radio Frequency) energy. Electrical items should be designed so they do not interfere with each other through RF emissions. E.g. If you turn on your microwave, your television shouldn't display interference if both items are CE marked to the EMC directive.

If emitted RF energy is not kept low, it can interfere with other electrical circuitry - E.g. Cars Automatic Braking Systems have been known to activate by themselves while in a strong RF field. As this has obvious repercussions ALL electrical products likely to cause RF related problems have to be 'CE' marked from 1st January 1996 onwards.

If a product conforms to the EMC directive, not only should its RF emissions be very low, but its immunity to RF energy (and other types) should be high. The apparatus has to resist many 'real world' phenomena such as static shocks and mains voltage transients.

## Viglen's Environment laboratory

To gain a 'CE' mark, the Viglen computer range has had to undergo many difficult tests to ensure it is Electromagnetically Compatible. These are carried out in the in-house 'Environment lab' at Viglen Headquarters. We have made every effort to guarantee that each computer leaving our factory complies fully with the correct standards. To ensure the computer system maintains compliance throughout its functional life, it is essential you follow these guidelines.

Install the system according to Viglen's instructions

If you open up your Viglen System:

- Keep internal cabling in place as supplied.
- Ensure the lid is tightly secured afterwards
- Do not remove drive bay shields unless installing a 'CE' marked peripheral in its place
- The clips or 'bumps' around the lips of the case increase conductivity - do not remove or damage.
- Do not remove any ferrite rings from the L.E.D cables.
- Only use your Viglen computer with 'CE' marked peripherals

This system has been tested in accordance with European standards for use in residential and light industrial areas-this specifies a 10 meter testing radius for emissions and immunity. If you do experience any adverse affects that you think might be related to your computer, try moving it at least 10 meters away from the affected item. If you still experience problems, contact Viglen's Technical Support department who will put you straight through to an EMC engineer - s/he will do everything possible to help. If modifications are made to your Viglen computer system, it might breach EMC regulations. Viglen take no responsibility (with regards to EMC characteristics) of equipment that has been tampered with or modified.

# Copyrights and Trademarks

---

## **Please note:**

The material in this manual is subject to change without notice.

## **Trademarks**

Microsoft, Windows, Windows XP, Windows 2000, Windows NT, Windows 95, MS-DOS and OS/2 are registered trademarks of Microsoft Corporation. i386, i486, Xeon, Pentium, Pentium Pro and MMX are registered trademarks of Intel Corporation. JAC-UP, Contender, Dossier, Vig, Viglen, VigStor and Envy are trademarks of Viglen Limited. Genie and Contender are registered trademarks of Viglen Limited.

## **Copyright and Patents**

This manual and all accompanying software and documentation are copyrighted and all rights reserved. This product, including software and documentation, may not, in whole or in part, be copied, photocopied, translated or reduced to any electronic or machine-readable form, without prior written consent except for copies retained by the purchaser for backup.

© Copyright 2005 Viglen Limited  
All Rights Reserved  
OMNINO HS – User Guide Version 1.0  
Printed in the United Kingdom

## **Liability**

No warranty or representation, either expressed or implied, is made with respect to this documentation, its quality, performance, merchantability or fitness for a particular purpose. As a result the documentation is licensed as is, and you, the licensee, are assuming the entire risk as to its quality and performance. The vendor reserves the right to revise this operation manual and all accompanying software and documentation and to make changes in the content without obligation to notify any person or organisation of the revision or change.

In no event will the vendor be liable for direct, indirect, special, incidental or consequential damages arising out of the use or inability to use this product or documentation, even if advised of the possibility of such damages. In particular, the vendor shall not have liability for any hardware, software or data stored or used with the product, including the costs of repairing, replacing or recovering such hardware, software or data.

# Contents

---

<b>1. Overview</b>	<b>6</b>
Checklist	6
<b>2. Setting up Your Omnino HS</b>	<b>7</b>
Unpacking your Omnino HS	7 - 11
<b>3. Safety Precautions</b>	<b>12</b>
Precautions	12 - 14
<b>4. General Description</b>	<b>15</b>
Front Control Panel	15 - 16
The Real Time Clock	17
Floppy Disk Drives	17
Hard Disk Drives	18
CD-ROM, CD-R/W, DVD-ROM, DVD-RAM Drives	18 – 19
Inserting/Removing CD's	20
System Memory	20
I/O Ports and the Interface Panel	21 - 23
USB Ports	23
IEEE1394 Firewire	24
Serial ATA	25
AGP (Advanced Graphics Port)	26
<b>5. Optional Features</b>	<b>28</b>
Audio	28
Graphics Card	29 – 30
Modem	31

<b>6. Troubleshooting</b>	<b>32</b>
What to do if your system doesn't work	32 – 34
<b>7. Glossary</b>	<b>38</b>
Commonly used computer terms	35 – 39
<b>8. Notes</b>	40 – 43
<b>9. Suggestions</b>	<b>44</b>

# 1. Overview

---

This manual describes the Omnino HS system. The motherboard is the most important part of your computer; it contains all of the CPU, memory and graphics circuitry that makes the Omnino HS work.

## Checklist

Please check that the following items have been included with your Omnino HS. If anything listed here is damaged or missing, contact Viglen.

In addition to the motherboard and chassis, various hardware components may have been included with your Omnino HS, as listed below:

- Main system unit
- AC power cord
- Keyboard
- Mouse
- Microsoft® Windows 2000/XP licence sticker and manual(s)

If you have purchased any alternative or optional products along with your system, they will be included with the package along with appropriate support documentation.

Congratulations on purchasing your Omnino HS system. This User Guide provides you with the information required to set up and use your Personal Computer system. It should be read in conjunction with the accompanying motherboard and peripheral manuals.

Your Omnino HS is based on, and is compatible with; the IBM Personal Computer and thus a vast range of software and add-on hardware products are available for use.

The system comes preconfigured with either Microsoft® Windows 2000 or XP Operating systems. More information can be found in the accompanying manuals.

There is a glossary at the end of this manual to explain unfamiliar computer jargon.

## 2. Setting up your Omnino HS

---

Detailed in this chapter is comprehensive information on how to unbox, assemble and use your Omnino HS system. The basic system consists of three main components, the input devices (keyboard/mouse), output devices (monitor/speakers) and the main system unit (also called the base unit). Examples are shown below.

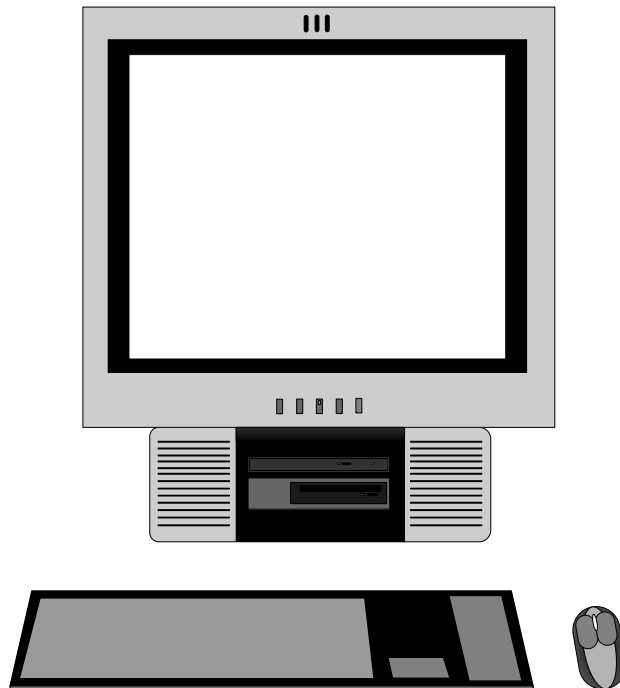

It is best if you give yourself a lot of space, and then unpack each box. It's easier to set-up the computer when everything is in front of you. Please follow these illustrated instructions.

### Step 1: Unpacking your Omnino HS

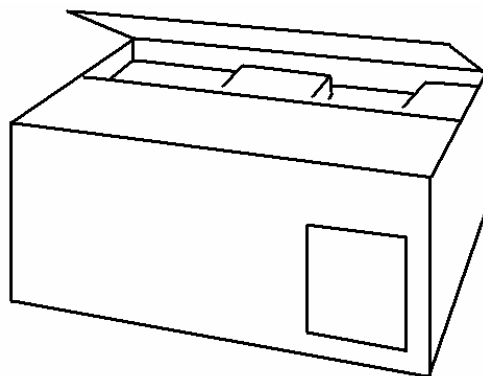

There should be two boxes that form your Viglen PC - a 'System Unit Box' and sometimes an 'Accessories Box'. Carefully unpack these boxes, and remove the contents.

**Note:** *DO NOT rest the unit on its screen.*



**Please Note:** It is important that you keep the packaging in case you have to return the unit at a later date. The packaging has been designed to give maximum protection to the system during transportation. No other alternatives would give as much protection. Viglen cannot be held responsible for any damage that occurs during transport.

### **Step 2:**

The unit can be lifted out and placed on your desk - depending on your personal preferences. As long as there is easy access to an AC mains socket, position the unit so that the rear is easily accessible. Place the Omnino HS, keyboard and mouse on the desk to suit your requirements.

### **Step 3:**

Connect the AC power supply cable to the back of the base unit.

**Note:** *On the Omnino HS, there is no power outlet socket for Monitors. Due to the monitor being built in there is no need to connect power to the monitor.*

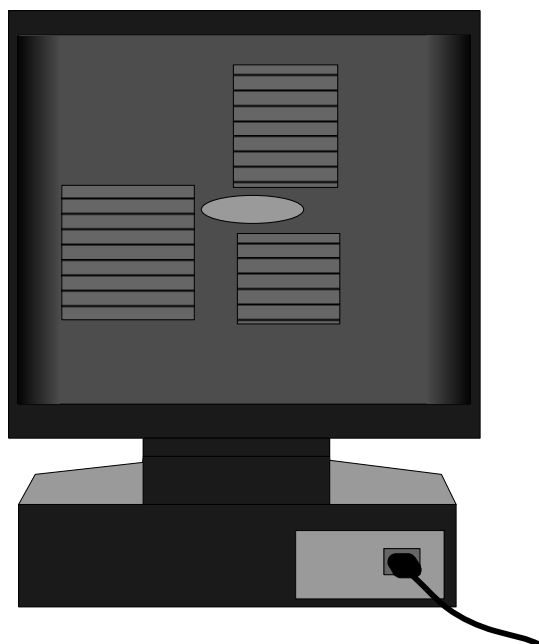

**Omnino HS – Rear View**



## Step 4:

Located underneath the rear of the base unit is an 'I/O Panel'. This is where you connect the peripheral devices that come with your Omnino HS. If your system has an 'on-board' sound card, the audio ports will be accessible. If these ports are covered, your system either has an 'add-in' sound card - or no audio available.

**Note:** On certain models, the ports maybe arranged differently. ALWAYS match the cables with the colours specified.

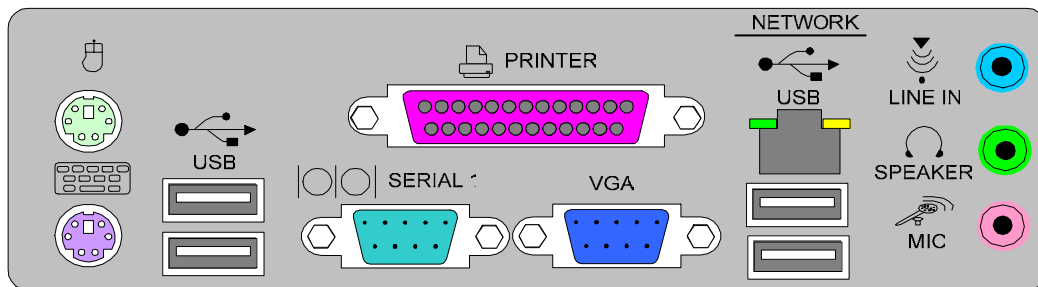

Omnino HS - Rear I/O Shield

## Step 5:

Connect the Mouse to the GREEN PS2 socket, and the Keyboard to the PURPLE PS2 socket. If you have a printer, plug the printer parallel cable into the PURPLE parallel socket. If you have a USB printer then plug the USB cable into any of the available USB ports.

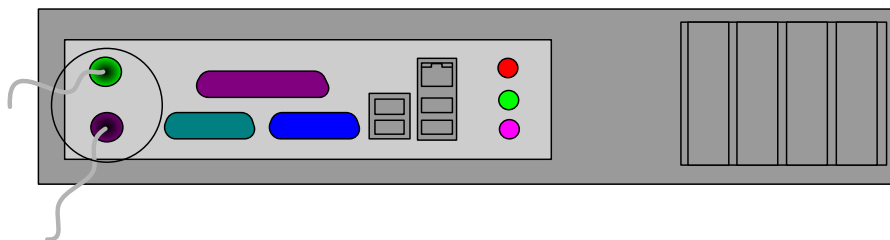

Omnino HS – I/O Panel

### Step 6:

Plug the video signal cable into the BLUE VGA connector; this is located on the Interface panel. Both options are shown below.

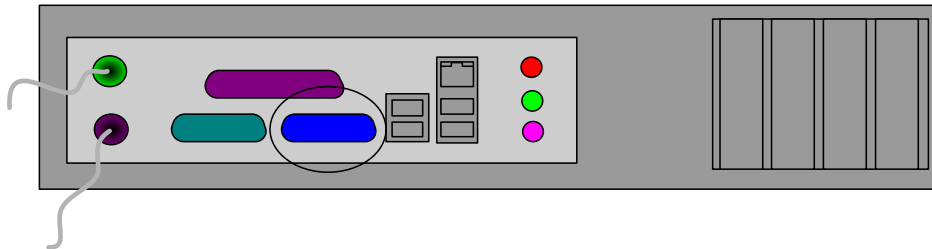

Omnino HS – I/O Panel

### Step 7:

Your Omnino HS may have an audio card installed (optional). Connect the stereo speaker cable to the socket labelled 'OUT' or marked with the following icon:

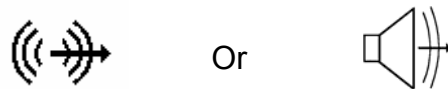

Plug your microphone into the socket labelled 'MIC' or marked with the following icon:



If your Omnino HS has an 'on-board' sound card, the audio ports will be located on the 'interface panel'. Connect the stereo speaker cable to the GREEN socket, and plug your microphone into the PINK socket. Both options are shown below.

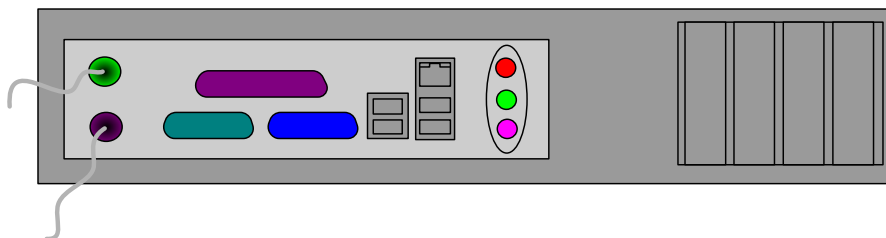

Omnino HS – I/O Panel

**DO NOT switch on the Omnino HS until steps 1 to 7 have been completed.**

## Step 8:

Plug the power cable into a standard mains socket, and switch on. Press the monitor power button on the front of the case – a green or orange light should appear under the button. Gently press the computer ON/OFF button, located on the side of the system – as shown below.



You are now ready to explore the features of your new Omnino HS computer... Enjoy!

**NOTE:** On most systems there is a 'cold' on/off switch on the back of the base unit (next to the power socket). This switch physically disconnects the computer from the power supply. If your Omnino HS is not switching on, try checking that this switch is turned 'on'.

## 3. Safety Precautions

---

### Electrical Safety Precautions

- *Basic electrical safety precautions should be followed to protect you from harm and the Omnino HS from damage:*
- *Be aware of the locations of the power on/off switch on the chassis as well as the room's emergency power-off switch, disconnection switch or electrical outlet. If an electrical accident occurs, you can then quickly remove power from the system.*
- *Do not work alone when working with high voltage components.*
- *Power should always be disconnected from the system when removing or installing main system components, such as the motherboard, memory modules and the CD-ROM and floppy drives. When disconnecting power, you should first power down the system with the operating system and then unplug the power cords of all the power supply units in the system.*
- *When working around exposed electrical circuits, another person who is familiar with the power-off controls should be nearby to switch off the power if necessary.*
- *Use only one hand when working with powered-on electrical equipment. This is to avoid making a complete circuit, which will cause electrical shock. Use extreme caution when using metal tools, which can easily damage any electrical components or circuit boards they come into contact with.*
- *Do not use mats designed to decrease electrostatic discharge as protection from electrical shock. Instead, use rubber mats that have been specifically designed as electrical insulators.*
- *The power supply power cord must include a grounding plug and must be plugged into grounded electrical outlets.*
- *Motherboard Battery: **CAUTION** - There is a danger of explosion if the onboard battery is installed upside down, which will reverse its polarities. On the Omnino HS, the positive side should be facing up. This battery must be replaced only with the same or an equivalent type recommended by the manufacturer. Dispose of used batteries according to the manufacturer's instructions.*

## **General Safety Precautions**

Follow these rules to ensure general safety:

- *Keep the area around the Omnino HS clean and free of clutter.*
- *Place the chassis top cover and any system components that have been removed away from the system or on a table so that they won't accidentally be stepped on.*
- *While working on the system, do not wear loose clothing such as neckties and unbuttoned shirt sleeves, which can come into contact with electrical circuits or be pulled into a cooling fan.*
- *Remove any jewelry or metal objects from your body, which are excellent metal conductors that can create short circuits and harm you if they come into contact with printed circuit boards or areas where power is present.*
- *After accessing the inside of the system, close the system back up and secure it to the rack unit with the retention screws after ensuring that all connections have been made.*

## **ESD Precautions**

*Electrostatic discharge (ESD) is generated by two objects with different electrical charges coming into contact with each other. An electrical discharge is created to neutralise this difference, which can damage electronic components and printed circuit boards. The following measures are generally sufficient to neutralise this difference before contact is made to protect your equipment from ESD:*

- *Use a grounded wrist strap designed to prevent static discharge.*
- *Keep all components and printed circuit boards (PCBs) in their antistatic bags until ready for use.*
- *Touch a grounded metal object before removing the board from the antistatic bag.*
- *Do not let components or PCBs come into contact with your clothing, which may retain a charge even if you are wearing a wrist strap.*
- *Handle a board by its edges only; do not touch its components, peripheral chips, memory modules or contacts.*
- *When handling chips or modules, avoid touching their pins.*
- *Put the motherboard and peripherals back into their antistatic bags when not in use.*

- *For grounding purposes, make sure your computer chassis provides excellent conductivity between the power supply, the case, the mounting fasteners and the motherboard.*

### **Operating Precautions**

*Care must be taken to assure that the chassis cover is in place when the Omnino HS is operating to assure proper cooling. Out of warranty damage to the Omnino HS system can occur if this practice is not strictly followed.*

## 4. General Description

---

This section gives a general description and overview of the various features of your Omnino HS.

Various abbreviations will be used to describe the size of a computer's storage capacity. A unit of storage is known as a 'byte', or sometimes as an 'octet' - 1024 bytes is known as a 'Kilobyte' or 'KB'. Following on in this fashion, 1024KB is known as a 'Megabyte' or 'MB', and 1024MB is known as a 'Gigabyte' or 'GB'. Your computer's RAM will have in the region of 32MB to 256MB storage capacity, where your hard disk will have anything from 3.4GB to 18GB storage or even higher!

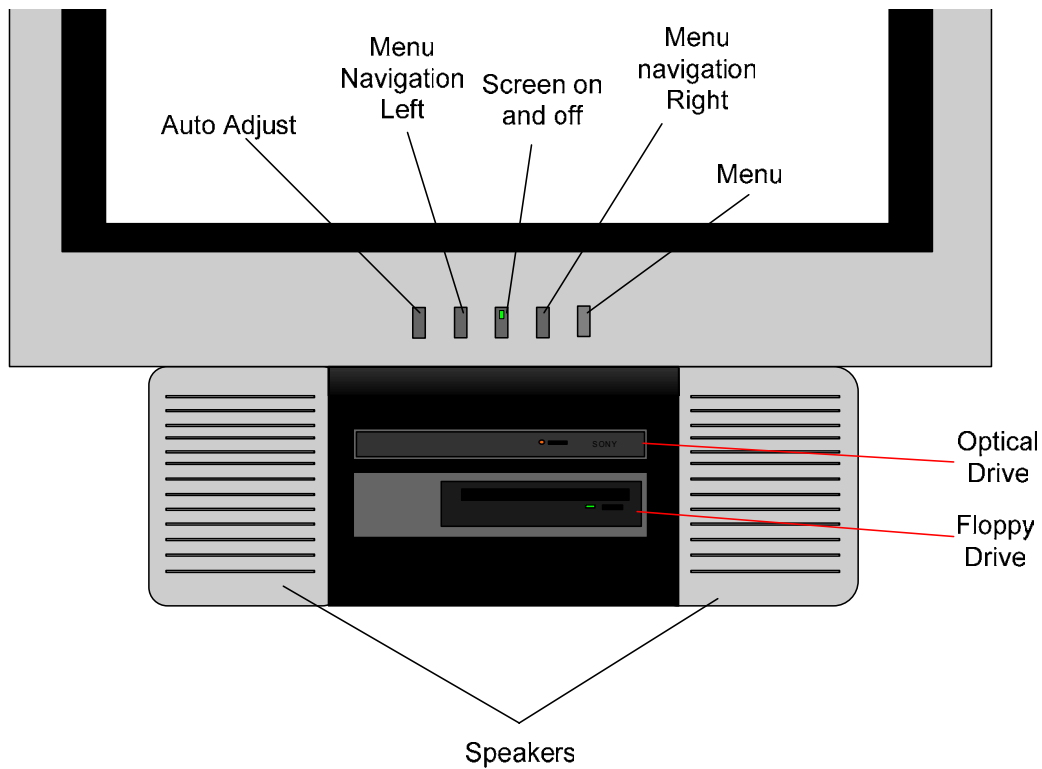

**Omnino HS – Front Control Panel**

## Front Control Panel

The functions of the various lights and switches are as follows:



**Power light (green):** When illuminated, this indicates that the system is switched on.

**Auto:** Automatically adjusts the screen.

**Left and Right arrow:** Navigates through the on screen menus.

**Menu:** Accesses the on screen menu.



**Power Switch:** The power switch is used to turn the system On and Off. The Omnino HS has an advanced power management system, which includes an electronic power switch. With the advanced power management system, the Operating System can turn the computer off automatically if asked.



## **The Real Time Clock**

Viglen PC's are IBM AT compatible computers and hence the whole system configuration is set up in battery-backed CMOS RAM. This information indicates the type of hardware and memory configuration that the system includes. It is important that this information is set up correctly; otherwise the computer may find errors and may not be able to access the hardware correctly. The correct information is preset for you; however, you can change this information if required by running the SETUP utility. Refer to the motherboard manual for further details. The time and date information is also stored in the battery-backed RAM. Thus, when the power is switched off, the time and date is kept running and will be correctly set up the next time that the computer is switched on again. The correct time and date is also preset for you but can be changed if required by double clicking on the clock in the lower right hand side of your Windows desktop.

## **Floppy and Hard Disk Drives**

Your computer requires storage and memory devices in order to store programs and data and any other information. This memory can be either volatile or non-volatile. Information stored in volatile memory is lost when the power is switched off - but with non-volatile memory, the information is retained.

The most important type of non-volatile memory is obtained by storing information on magnetic media called disks or diskettes. System Information is also stored in battery backed memory where a battery supplies power to maintain the information when the mains power is turned off. The hardware units that are used to store information on magnetic disks are called disk drives.

The two most common types of disk drives are Floppy Disk Drives and Hard Disk Drives.

### **Floppy Disk Drives**

Floppy Disk Drives enable the computer to read from, or write to, floppy disks that are inserted into the drive. These disks can then be removed or taken to another computer where they can also be used. The information is stored as a 'magnetic picture', and held permanently on the disk until deletion of the data.

A 1.44MB drive can read and write both 720KB and 1.44MB format disks. If a 720KB formatted disk is inserted the drive will automatically read and write in the 720KB format. Likewise, if a 1.44MB formatted disk is inserted; the system will automatically read and write in the 1.44MB format. The 3.5" FDD is the standard drive for flexible data storage and transferral – you might buy some software that comes on 3.5" floppy disk for instance.

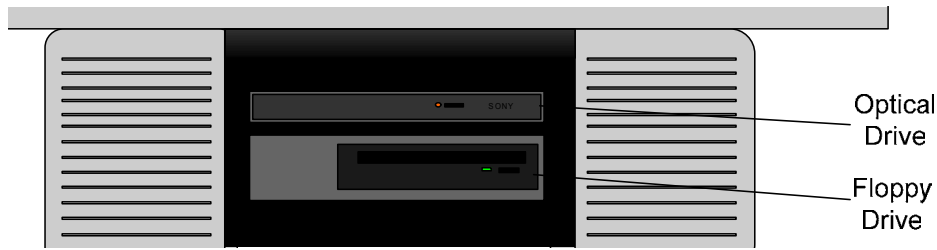

### Omnino HS – Floppy Disk Drive

**NOTE:** *The correct type of disk must be used for the correct format. There is a disk sensing unit on the drive which will not allow the wrong media type of disk to be used. i.e. a 720K formatted disk must be a standard double-density media and a 1.44M formatted disk must be a high-density media.*

If the write-protect hole is "OPEN" (i.e. you can see through it), it indicates that the disk is write protected. In this state, you will be unable to change the contents of the disk. If you close the hole (by sliding the plastic insert across), the disk is NOT write-protected. In this state, you can write to, and delete information from the disk.

### Hard Disk Drives

A hard disk operates in a similar way to a floppy disk with one major difference. The disks used to store the information are sealed inside the mechanism and cannot be removed. Because the unit is sealed, more than one disk can be included and the data on these disks can be packed in a far greater density.

Today, hard disk storage capacity is measured in 'GB' (Gigabytes). One GB is equivalent to:

1,073,741,824 characters of information, or 'bytes'...

If a book had 80 characters on each line, 40 lines of text on each page and 300 pages – you'd be able to fit all the information in the book onto a 3.4GB hard disk – not once, but over 3,803 times!!

It is advised to keep your hard disk 'clean' (in a data sense rather than a physical sense!). If you are not going to use a certain application ever again, uninstall it rather than just leaving it on your hard disk. For information about uninstalling an application, please refer to the accompanying documentation.

### CD-ROM, CD-R/W, DVD-ROM, DVD-RAM Drives

Your Omnino HS has been supplied with either a high speed (52x or above) CD-ROM, or a DVD-ROM drive, according on which model you purchased. CD-ROM's and DVD-ROM's are both medium speed, non-volatile mass storage devices. The large storage capacity and cheap manufacturing has made the CD the ideal medium for multimedia and the distribution of large program suites such as Operating Systems. DVD disks are very similar CD-ROM's, but their storage capacity is much greater.

## **CD-ROM Drive**

The CD-ROM drive in your machine has the capability to spin CD's at up to thirty two (or higher) times the original specification for CD ROM drives. This allows it to read the information from the surface of the CD at a very high speed, stopping the CPU from waiting for the next piece of information. Your drive has already been configured for your system and is ready to use after booting the computer. Your CD-ROM will take the first drive letter available after the last Hard Drive. In most cases this will be **D:**

## **CD-R/RW Drive**

A CD-R/RW drive works in much the same way as a standard CD-ROM drive except that it has the capability to write to blank CD-R or CD-RW media. A CD-R disc can only be written to once where as a CD-RW disc can be written to and erased many times.

## **DVD-ROM Drive**

DVD stands for 'Digital Versatile Disk', and is the successor to the standard CD-ROM technology. DVD drives have the ability to access over 17GB of information on a single DVD disk, while maintaining backwards compatibility with standard CD-ROM's. DVD was primarily pioneered for the film industry – its massive storage means it's possible to place a blockbuster film on just one disk. In fact, you can also have the film in many different languages as well.

The DVD drive uses dual-focus laser technology, and is one of the most advanced pieces of CD based technology there is.

## **DVD-RAM Drive**

The DVD-RAM drive has the same capabilities as a DVD-ROM drive with the additional benefit of being able to write to blank DVD-R media.

## Inserting/Removing a CD:

- 1) To Insert a CD into your CD-ROM/DVD drive simply press the Eject button on the front of the drive. This will cause the CD-ROM/DVD drive to eject the CD tray, after the drive has been ejected pull the tray the rest of the way.



- 2) Place the CD in the centre of the tray and ensure it is sitting in the spindle of the CD-ROM drive.
- 3) Press the Eject button once more and the tray will retreat back into the machine with the CD in the tray.
- 4) The CD is now loaded and will be automatically read to ascertain a label name and other details.
- 5) The CD is now accessible from the D: drive.

To remove a CD repeat the above steps 1-3 removing the CD at step 2.

If you insert an audio CD into your drive, your computer will automatically start to play the first track on the CD.

## System Memory

Your Omnino HS will use some of the latest memory technology available at the time. The system memory is volatile memory and is used by the computer as storage whilst it is operating. All the information held in this memory is lost when the power is switched off.

To identify the amount of RAM supplied in the system (typically 128MB to 2GB). You must make sure that there is enough memory to run your required program.

The amount of memory required is normally indicated on the software package.

Cache RAM is the fastest type of RAM you can get (and the most expensive). It sits in-between the processor and the main system memory, and stores data that is repeatedly required by the CPU.

A typical system has 512KB of Cache RAM – or 128KB cache if a Celeron processor is installed.

## I/O Ports and the Interface Panel

The communication between your Omnino HS and other devices is performed via I/O (Input/Output) interfaces or 'ports'. You will probably never use all the ports on the back of your computer, but a wide selection is available for maximum flexibility. All of the industry standard ports are available, and they are individually coloured and labelled with icons for simple installation of peripherals.

This section of the manual will explain the different uses of each port, and a little on the peripheral types.

Most of the I/O ports on the back of your Omnino HS have been conveniently grouped into one area. This region of the PC is known as the 'Interface Panel'.

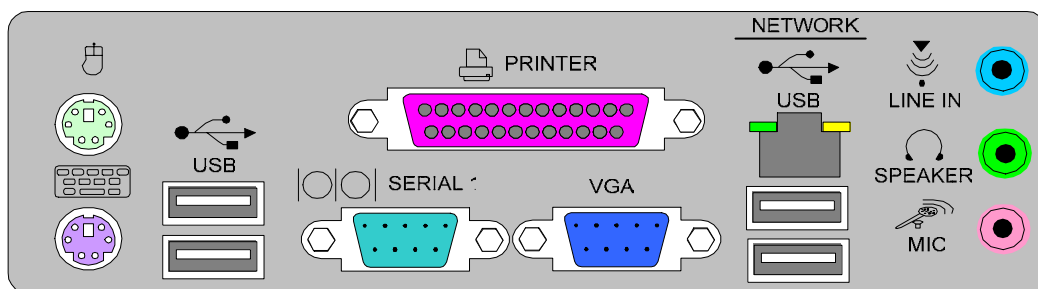

Omnino HS - Interface Panel

**Note:** Your system may be configured slightly differently to the diagram above. The Games, Speaker, Line-in and Mic-in ports maybe on a separate add-in card – or you may not have audio at all in your configuration. On some systems, the second serial port is actually the VGA port instead (to connect the PC to the monitor). Please ensure you understand the configuration of your Viglen system before attempting to install it.

Your Interface Panel may have a slightly different layout to the diagram above. Always use the colours and symbols to locate the correct I/O ports.

## I/O Port descriptions:



### **PS/2 port (mouse) (Green)**

The PS/2 port is the industry standard for connecting a mouse to a PC. Before inserting the cable into the socket, ensure you have lined the pins up. There is only one way the cable can be inserted, so if it's not going in – do not use excessive pressure!



### **PS/2 port (Keyboard) (Purple)**

The PS/2 port is also the industry standard for connecting a keyboard to a PC. Before inserting the cable into the socket, ensure you have lined the pins up. There is only one way the cable can be inserted, so if it's not going in – do not use excessive pressure!



### **USB port (Black)**

USB stands for Universal Serial Bus, and has been designed into your system to ensure full compatibility with future peripheral technologies. Most devices in the future such as keyboards, scanners, joysticks and speakers will come with a USB port attached. It has been designed with ease of use in mind – allowing you to plug in a USB peripheral and use it without restarting your computer. There are two USB ports on your system.



### **Parallel port (Burgundy / Red)**

The parallel port is also known as a Centronics port (named after the company that originated the standard), and is used mainly to connect printers or scanners to your computer.



### **Serial port (Turquoise)**

The serial port uses the international RS232C (or updated) standard to provide serial asynchronous communication. It can be used to connect external serial devices such as a modem, mouse etc. A printer with a serial port can also be connected to this port. On some systems, the rightmost serial port has been replaced by a VGA port.



### **VGA port (Dark Blue)**

The VGA port is the main interface between the base unit and the monitor. A thick 15-pin monitor cable is usually used to link the two units together. The VGA port will usually be found on an add-in card rather than the Interface Panel. On some systems, the rightmost serial port has been replaced by the VGA port to save space for more add-in cards.



### **Games port (Gold) - optional**

The game port is used to connect an IBM compatible analogue joystick. It also doubles up as a MIDI (Musical Instrument Digital Interface) port for playing or recording music (with the correct cable attached). This port has a 15-pin socket, and will either be located on the I/O panel or on an add-in card.

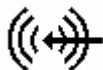

### **Line in (Light Blue) - optional**

'Line in' can be used if you wanted to digitally record an audio source. It accepts a standard 3.5mm audio jack, and records in stereo. If you are using a microphone to record audio, it's advisable to use the 'Mic in' instead of the 'Line in'. If installed, this port will either be located on the I/O panel or on an add-in card.



### **Mic in (Pink) - optional**

'Mic in' can be used to record your voice via an external Microphone. The record level of the microphone can be adjusted via software. The 'Mic in' port includes a small amplifier, and If you are recording from a powered source (Hi-Fi etc) it's suggested you use the 'Line in' for better sound quality. If installed, this port will either be located on the I/O panel or on an add-in card.

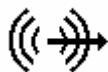

### **Speakers (Green) – optional**

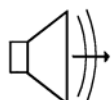

Connect your speakers or headphones to this stereo socket. Ensure the volume is turned down before connecting speakers to this port. If installed, this port will either be located on the I/O panel or on an add-in card.

## **USB Ports**

USB is an abbreviation of Universal Serial Bus. USB is a standard port that enables you to connect external devices (such as digital cameras, scanners, mice, keyboards, modems) to PC's. It is a standard designed to eliminate the guesswork in connecting peripherals to your PC.

USB replaces all the different kinds of serial and parallel port connectors with one standardised plug and port combination (see image below).



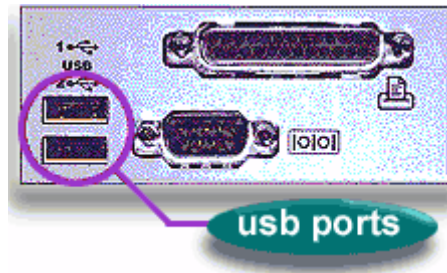

With USB-compliant PC's and peripherals, you just plug them in and turn them on! USB makes the whole process automatic.

Thanks to another USB feature known as 'hot-swapping' you don't even need to shut down and restart your PC to attach or remove a peripheral.

### USB Standards

Currently there are two versions of the USB standard that have been developed by the USB Implementers forum.



USB 1.1 (1995) defines two speeds 12Mbps (full speed) and 1.5Mbps (low speed) and two types of connectors: Series A and Series B.



USB 2.0 (2000) defines three speeds 480Mbps (high speed), 12Mbps and 1.5Mbps (full speed) and 1.5Mbps (low speed). It is completely backwards compatible with USB 1.1.

### IEEE1394 Firewire

Also known as Apple's FireWire™ and Sony's i-Link is an industry standard for a scalable, flexible, easy to use, low cost digital interface that integrates the world of consumer electronics and personal computers.



1394 is a digital standard and does not require the conversion of digital data into analogue, which means better signal integrity. It supports guaranteed delivery of time critical data which enables high-quality audio and video applications.



The IEEE1394 interface has been designed to be physically small and easy to use. Devices can be added and removed without requiring the PC to be rebooted (IEEE1394 supports hot-swapping).

### IEEE1394 Standards

There are two IEEE1394 standards currently available. Standard (a) supports transfer rates up to 400Mbps and standard (b) supports up to 800Mbps.

Shown below are example images of the two different IEEE1394 ports and the different interface cables used:



Standard 6-pin port



Standard 4-pin port

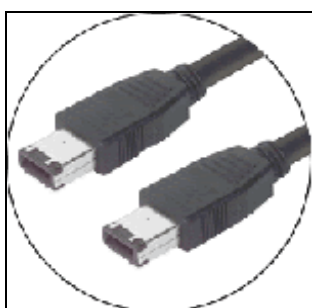

6-6 pin cable

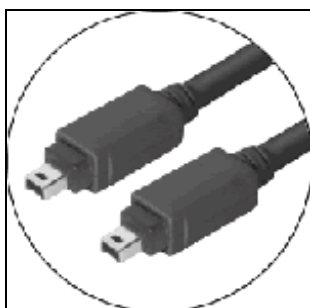

4-4 pin cable



4-6 pin cable

### Serial ATA

A disk-interface technology developed to replace parallel ATA. When most people think "serial", they tend to think of the serial ports found on the rear I/O of a PC. These asynchronous serial ports are very slow but synchronous serial offers greatly improved data throughput. A typical asynchronous serial port is capable of 115kb/s but a serial ATA port (synchronous serial port) can support a throughput of more than 1,000,000kb/s.



S-ATA not only offers faster transfer rates but also a better cabling solution compared to the older P-ATA (Parallel-ATA) 40-pin standard (see below):

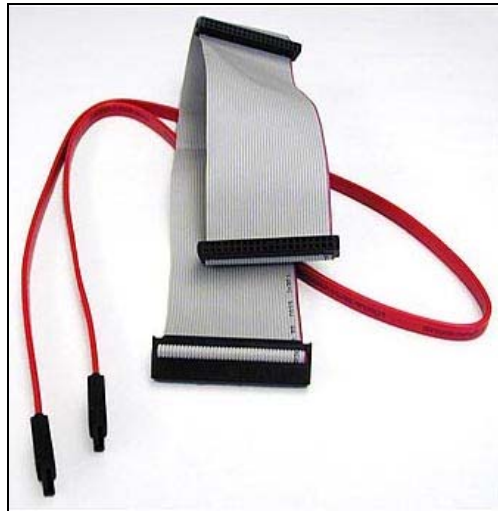

**Parallel ATA (grey cable) Vs Serial ATA (red cable)**

## **AGP (Advanced Graphics Port)**

AGP is a high performance interconnect between the chipset and graphics controller for enhanced 3D graphics performance. AGP relieves the graphics bottleneck by adding a dedicated high-speed interface directly between the chipset and the graphics controller as shown below:

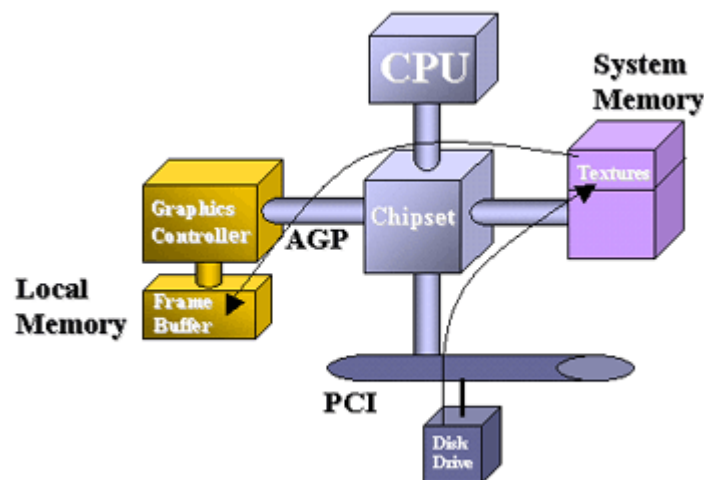

## **AGP Standards**

There are two specifications that define AGP. The AGP Specification revision 2.0 defines an interface supporting 1x and 2x speeds at 3.3V and 1x, 2x, and 4x speeds at 1.5V signalling. The AGP3.0 specification defines a new signalling scheme for 4x and 8x speeds at .8V signalling levels.

## Connecting your Monitor

- 1) Turn off the power of your computer and other devices.
- 2) Connect the video signal cable of the monitor to the 15-pin VGA connector on the back of your computer. The VGA port will either be on the Interface Panel, or mounted on an add-in card. The port is labelled with the following icon:



- 3) Turn on the computer.
- 4) If necessary, adjust the front panel controls accordingly to your personal preference.

## 5. Optional Features

---

This chapter explains some of the optional features you may have ordered with your Omnino HS. If you have a basic configuration, then you can skip this section of the manual.

Your Omnino HS has been engineered to give you a powerful yet manageable computing experience. You have the option to upgrade your Omnino HS, or add a component whenever you require. So if you don't have audio now - it doesn't mean you can never have it. Just contact the Viglen Service department for a catalogue of upgrades for your system.

### Audio ports

The audio ports connect your computer to external devices such as a microphone or a set of speakers. If you have purchased audio with your Viglen Omnino HS, there will either be a set of speakers supplied with the computer or built into the monitor.

The audio ports on your Omnino HS will either be located on the Interface Panel, or on a separate add-in card. Either way, the internationally accepted port icons will be the same:

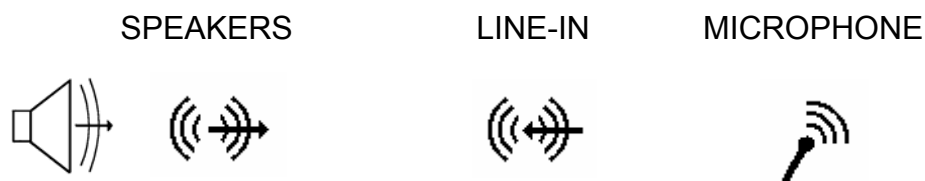

If your Omnino HS has external speakers supplied, there will be a separate instruction sheet supplied with the speakers describing the installation. Please read this sheet before continuing.

Generally, the external speaker system will consist of two separate units to reproduce a stereo signal. If you have selected a high power unit, you will probably receive three speakers... left, right, and a subwoofer.

However these speakers are attached to each other, there will always only be *one* cable to connect the speakers to the PC. This will take the form of a stereo 3.5mm jack:

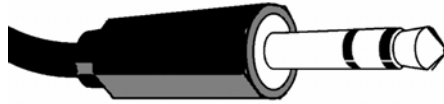

**Omnino HS** - A stereo 3.5mm Jack

You must plug this jack into the 'Speaker' port on the computer.

The speaker port on your computer will be labelled with one of the following international symbols:

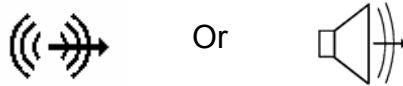

The volume of your speakers can either be controlled by software, or by the volume controls on your speakers (see the supplied documentation for further information).

***WARNING: Ensure your speaker system volume is turned down before you connect the speakers.***

## Graphics Card

If a separate graphics card has been supplied with your system, this section will look at the best way to set it up. It is possible you have one of a number of I/O options on the 'back plates' of your graphics card - this section will explain how to set up each variant.

### Diagram Keys:

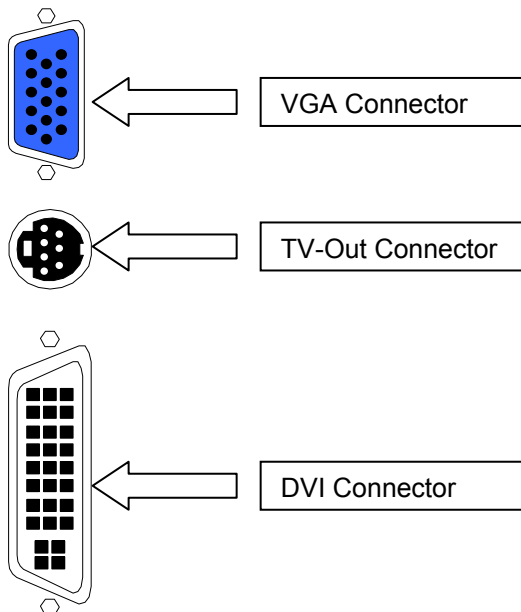

## VARIANT 1 - Standard VGA Card

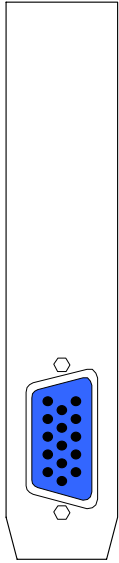

**Variant 1** shows a typical example of a VGA card. The monitor connector cable will only fit one way and can normally be screwed into the graphics card itself.

## VARIANT 2 - Standard VGA Card + TV Out

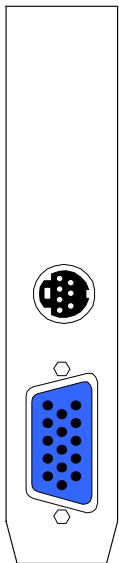

**Variant 2** shows a typical example of a VGA card with TV Out. The monitor connector cable will only fit one way and can normally be screwed into the graphics card itself. The TV/Composite video cable plugs straight into the TV Out socket.

## Modem

If a modem has been supplied with your system, this section will look at the best way to set it up and connect your computer to the outside world. It is possible you have one of a number of 'back plates' on your modem - this section will explain how to set up each of the variants.

### VARIANT 1:

This modem may or may not have voice capabilities. Please consult the Supplied documentation for further information.

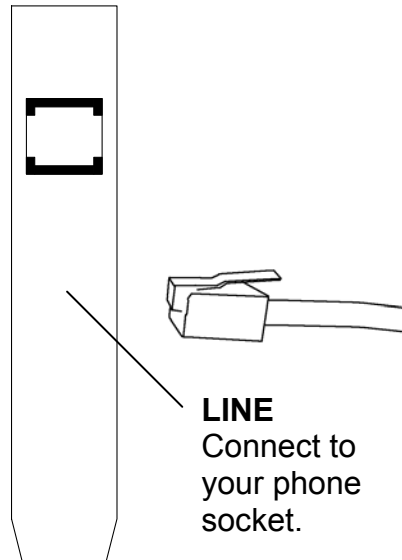

### VARIANT 2:

Your modem has a 'line' and a 'phone' socket - both are labelled. Connect the cable supplied to the socket labelled 'line'. The other socket can be used to install a phone if you desire.

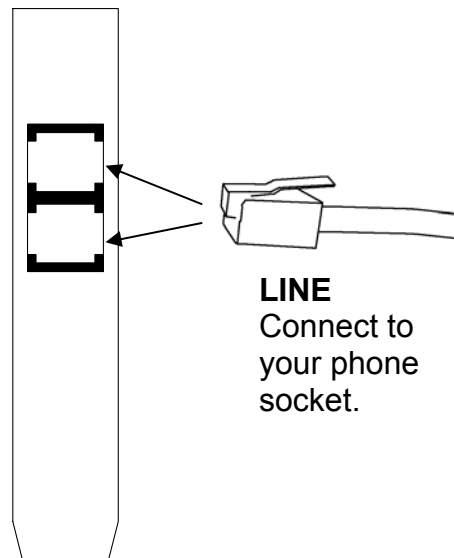

## 6. Troubleshooting

---

### What to do if the system doesn't work

This section describes basic problems and the remedies that can be used if the system does not seem to work correctly. Most problems can be sorted out very quickly once the root cause is established.

Before seeking assistance, have a look at these common problems and their possible solutions.

Try, wherever possible to isolate the problem by trying out a replacement device (i.e. mouse, keyboard etc.) if one is at hand. This will help you identify the item that is causing the problem and make it easier for the problem to be efficiently dealt with.

**Note:** Please don't remove the system unit cover: This action should only be performed by a qualified engineer, as you risk injury by hazardous voltages.

Problem	Action
No Power. No Lights on Front of the main system unit	Check AC mains cable is plugged firmly in the back of the main system unit.
	Check power On/Off switch is in the ON position.
	Check the fuse in mains plug. If it has blown, replace it with one of the same rating. If the fuse blows persistently, then unplug the power cable to the monitor and try again.

Problem	Action
Main system unit is OK, but no display or incorrect display on monitor	Check the power light on the monitor. If this is not lit, then check that the monitor power ON/OFF switch is in the ON position. Check that the AC power lead at the rear of the monitor is plugged firmly into the monitor and the power outlet at the rear of the main system unit.
	If the power light on the monitor is lit and the screen is blank, then test the following:  a) Turn the contrast and brightness controls on the monitor in case they have been set to dark.  b) Check that the signal cable at the back of the monitor is plugged into the socket labelled VGA or at the rear of the main system unit.  c) If some of the colours are missing, check that the pins on the signal cable are not bent.  d) Check that the video display card is correctly seated in the expansion slot.



<b>Problem</b>	<b>Action</b>
Main system unit is OK, but no display or incorrect display on monitor	Check the power light on the monitor. If this is not lit, then check that the monitor power ON/OFF switch is in the ON position. Check that the AC power lead at the rear of the monitor is plugged firmly into the monitor and the power outlet at the rear of the main system unit.
	<p>If the power light on the monitor is lit and the screen is blank, then test the following:</p> <p>e) Turn the contrast and brightness controls on the monitor in case they have been set to dark.</p> <p>f) Check that the signal cable at the back of the monitor is plugged into the socket labelled VGA or at the rear of the main system unit.</p> <p>g) If some of the colours are missing, check that the pins on the signal cable are not bent.</p> <p>h) Check that the video display card is correctly seated in the expansion slot.</p>

<b>Problem</b>	<b>Action</b>
Unit does not boot from hard disk drive C:	<p>If the hard disk cannot be accessed at all, then check the following:</p> <p>a) Check that the correct hard disk type is entered in the CMOS RAM by entering the SETUP routine. Refer to the System manual for further information.</p> <p>b) Check that the leads to the hard disk and from the IDE controller are plugged in fully</p>
	Try to boot from the floppy drive in drive A: by placing the Windows start-up disk in drive A and resetting the system. Once your computer has booted up, you should then try to access the hard disk by entering C: This is done by entering: <b>C:.</b> , now try entering <b>DIR</b>
	If the hard disk can be accessed through MS-DOS (if performing the above point did not return an error), but will not boot normally - the system files have been damaged. Back up all of your data, and reinstall you operating system from scratch.

<b>Problem</b>	<b>Action</b>
Floppy disk drive does not read or write	Check that the correct type of floppy disk is being used. Remember a 1.44MB Floppy Disk Drive will not read LS-120 disks.
	Try another disk... Sometimes floppy disks may get dust or scratched on the surfaces, damaging them.
	Check in the CMOS SETUP routine that the correct type of drive has been selected. (Refer to your System manual).

<b>Problem</b>	<b>Action</b>
No input from the keyboard	Check that the keyboard plug is firmly inserted into the socket labelled 'keyboard' at the rear of the main system unit. If the 'Caps Lock' LED lights up when pressed, there is an electrical connection.

<b>Problem</b>	<b>Action</b>
The mouse is not being recognised.	The mouse is not plugged in correctly.  <b>Solution:</b> Check mouse plug - make sure the plug is inserted in the correct port. The plug may become loose after prolonged use.

## 7. Glossary

---

This section gives a brief description of the most commonly used computer terms.

<b>A</b>	Ampere, This is a term of measurement for electric Current.
<b>AC</b>	Alternating Current used to describe the mains voltage.
<b>Ampere</b>	This is a term of measurement of electric current.
<b>Analog</b>	Pertaining to data in the form of continuously variable quantities. Contrasts with Digital.
<b>ANSI</b>	American National Standards Institute.
<b>ASCHS</b> Interchange.	American Standard Coded for Information  This is a special 7/8 bit code that is given to identify characters.
<b>Asynchronous</b>	a Method of transmission of data in which the bits included in a character or block of characters occur during a specific time interval. The start of each character block can occur at any time during this interval. Contrasts with synchronous.
<b>AUTOEXEC.BAT</b>	A special batch file, which contains a series of commands that are to be executed when the computer is started up.
<b>BASIC</b>	Beginner's All-purpose Symbolic Instruction Code. This is a simple programming language.
<b>Battery-Backed RAM</b>	A type of memory that holds information even when the computer is switched off.
<b>Baud</b>	A term used to measure modem data rates.
<b>Binary</b>	Involving a choice of two conditions, such as "yes" or "no", "1" or "0", base-2 mathematics.
<b>BIOS</b>	Basic Input Output System. This is the program held in the computer's ROM which handles all the input and output functions.
<b>Bit</b>	Synonym for Binary digit. A single unit of information which can hold a value of 0 or 1.

<b>Boot</b>	The name given to the program that runs on the computer when it is first switched on. Can also be a verb related to running the program.
<b>BSI</b>	British Standards Institute.
<b>Bps</b>	Bits per second.
<b>Buffer</b>	An area of temporary storage.
<b>Bus</b>	One or more conductors used for transmitting signals.
<b>Byte</b>	A unit of data made up of eight Bits.
<b>C / C++</b>	A programming language.
<b>Cache</b>	A small area of high-speed memory.
<b>Cathode Ray Tube (CRT)</b>	Normally referred to as a monitor or VDU.
<b>Character</b>	A symbol on the screen or same as a Byte.
<b>CMOS</b>	Complementary Metal Oxide Semiconductor. A logic circuit family that uses very little power.
<b>COM1, COM2 COM3, COM4</b>	The names given to the serial communications ports in DOS.
<b>CONFIG.SYS</b>	A special purpose file which has the configuration details for the computer to set itself to when powered up.
<b>CPS</b>	Characters per second.
<b>CSA</b>	Canadian Standards Association.
<b>Cursor</b>	A bar on the screen that indicates where the input from the keyboard will be displayed.
<b>DC</b>	Direct current. Normally associated with battery current.
<b>Digital</b>	Pertaining to data in the form of binary digits. Contrasts with Analogue.
<b>DIN</b>	Deutsche Industrie Norm specifies major connector types.
<b>DIP</b>	Dual In-Line Package. ICs that have two parallel rows of connections.

<b>DMA</b>	Direct Memory Access. A method of transferring data between main storage and I/O devices without processor intervention.
<b>Disk</b>	See Floppy Disk.
<b>DOS or MS-DOS®</b>	Disk Operating System or Microsoft® Disk Operating System. This is a low-level program that instructs the computer on basic file handling.#
<b>DRAM</b>	Dynamic RAM. A type of RAM that requires a periodic refresh to maintain data.
<b>DVD</b>	Digital Versatile Disk
<b>EMC</b>	Electromagnetic Compatibility
<b>EMI</b>	Electromagnetic Interference.
<b>EPROM</b>	Erasable Programmable Read-Only Memory.
<b>ESDI</b>	Enhanced Small Device Interface, which specifies a fast hard disk interface.
<b>FCC</b>	Federal Communications Commission.
<b>Firmware</b>	A program that is resident in Read Only Memory (ROM).
<b>Floppy Disk</b>	A storage device consisting of a flexible magnetic disk inside a protective cover.
<b>G</b>	A symbol used to represent the prefix Giga. i.e. GB (Giga Byte).
<b>GB</b>	Gigabyte, represents 1,073,741,824 bytes (1024MB).
<b>Hard Disk</b>	A disk of rigid magnetic material used for mass storage.
<b>Hardware</b>	The physical equipment which makes up the computer system.
<b>Hertz (Hz)</b>	A unit of measurement of frequency amounting to one cycle per second.
<b>Hex</b>	Hexadecimal. Base-16 mathematics.
<b>IC</b>	Integrated Circuit.
<b>Icon</b>	A graphical symbol.

<b>IDE</b>	Integrated device interface. An AT bus specification for a fast hard disk.
<b>IEC</b>	International Electrotechnical Commission. Specifies standards of safety.
<b>I/O</b>	Input/Output. Refers to data being sent to or received from a computer.
<b>K</b>	Symbol used to represent Kilobyte which is 1024 bytes.
<b>KB</b>	Abbreviation for Kilobyte, i.e. 1024 bytes.
<b>Kb</b>	Abbreviation for Kilo bit, i.e. 1024 bits.
<b>Keylock</b>	A locking device which can deactivate a keyboard.
<b>KHz</b>	KiloHertz. 1000 Hertz.
<b>LIM</b>	Lotus/Intel/ Microsoft <sup>®</sup> Expanded Memory Manager specification.
<b>LED</b>	Light Emitting Diode. These are normally used as the lights on a computers front panel.
<b>LPT1, LPT2, LPT3</b>	Names given to the printer ports by DOS.
<b>M</b>	Prefix mega. Equivalent to 1024K.
<b>mA</b>	Milliampere. 0.001 Ampere.
<b>MB</b>	Abbreviation for Mega Byte i.e. 1024K Bytes.
<b>Mb</b>	Abbreviation for Mega Bits, i.e. 1024K bits.
<b>Memory</b>	An electronic component, which remembers data, stored in it.
<b>MHz</b>	Mega Hertz. 1,000,000 Hertz.
<b>ns</b>	Nano Second 0.000 000 001 second.
<b>Pixel</b>	The smallest displayable unit on a monitor or picture tube.
<b>POST</b>	Power-On Self Test.
<b>RAM</b>	Random Access Memory. Fast Read/Write memory.
<b>RFI</b>	Radio Frequency Interface.

<b>ROM</b>	Read Only Memory.
<b>RS-232C</b>	A standard for asynchronous serial communication.
<b>SCSI</b>	Small Computer Systems Interface. A multimedia bus and interface specification for fast Hard Disks, Tape Backup Units, CD ROMs and other Devices.
<b>SIMM</b>	Single In-Line Memory Module.
<b>Software</b>	Another name for a computer program.
<b>SRAM</b>	Static RAM. Synchronous Transmission of data between devices which are maintaining the same frequency relationship. Contrasts with asynchronous.
<b>TPI</b>	Tracks Per Inch.
<b>TTL</b>	Transistor Transistor Logic.
<b>TUV</b>	Technischer Überwachungs-Verein. Organisation which tests and certifies electronic equipment.
<b>UL</b>	Underwriter Laboratories. American Organisation specifying standards for safety of electronic equipment.
<b>USB</b>	Universal Serial Bus
<b>V</b>	Volt. Unit of measurement of potential difference.
<b>VAC</b>	Volts (Alternating Current).
<b>VDE</b>	Verband Deutscher Electrotechniker. German organisation specifying EMI suppression.
<b>Video</b>	Computer data or graphics displayed on a monitor or screen.
<b>W</b>	Watt.
<b>Watt</b>	Basic unit of measurement of electrical power.











# 9. Suggestions

---

Viglen is interested in continuing to improve the quality and information provided in their manuals. Viglen has listed some questions that you may like to answer and return to Viglen. This will help Viglen help to keep and improve the standard of their manuals.

1. Is the information provided in this and other manuals clear enough?

---

---

---

---

---

---

---

2. What could be added to the manual to improve it?

---

---

---

---

---

---

---

3. Does the manual go into enough detail?

---

---

---

---

---

---

---

4. Would you like an on-line version of this manual?

---

---

---

---

---

---

---

5. How do you rate the Viglen Technical support and Service Departments?

---

---

---

---

---

---

6. Are there any technological improvements that could be made to the system?

---

---

---

---

---

---

---

---

1. Other points you would like to mention?

---

---

---

---

---

---

---

---

---

---

---

---

---

---

---

---

---

---

Please return this slip to: Product Development Department  
Viglen Ltd  
Viglen House  
Alperton Lane  
Alperton  
Middlesex  
HA0 1DX